

PEDRALI S.p.A.

sp 122 Mornico al Serio - 24050 BERGAMO - ITALY
Export Dept. Tel: +39 035 8358840 Fax +39 035 8358888
Ufficio Commerciale Italia Tel: +39 035 8358810 Fax +39 035 8358888

www.pedrali.it - info@pedrali.it

LASTINGTABLES 2015

BASAMENTI E TAVOLI

PEDRALI

LASTINGTABLES.1501

PEDRALI[®]
DYNAMIC DESIGN

LASTINGTABLES 2015

OX ARKI-TABLE YPSILON TOGO YPSILON NIKON YPSILO
DRO SNOW PARENTHESIS BOLD FEAT KUADRO JUMP N STYLUS BOLD
HESIS SURFACE
M SERIF N EXTES A FOG TONDA MOW P FABRICO BOLD
LA J A N EXTES A FOG TONDA MOW P FABRICO BOLD
M SERIF N EXTES A FOG TONDA MOW P FABRICO BOLD
LA J A N EXTES A FOG TONDA MOW P FABRICO BOLD
M SERIF N EXTES A FOG TONDA MOW P FABRICO BOLD
LA J A N EXTES A FOG TONDA MOW P FABRICO BOLD

LASTING**TABLES** 2015

Basamenti - Table bases

- Bold p. 40
- Dream p. 96
- Easy p. 128
- Florence p. 138 (143)
- Freddy p. 126
- UPDATE** Ikon p. 04
- UPDATE** Inox
 - Colonna Ø 50 e 50x50 p. 58
 - Verniciati p. 68
 - Colonna Ø 76 e 80x80 p. 70
 - base quadrata e rettangolare p. 80
 - Colonna Ø 76 - base tonda p. 85
 - Permanent p. 88
 - Ellittico p. 90
 - Colonna in legno p. 127
- Jimmy p. 127
- UPDATE** Krystal p. 52
- Laja p. 16
- Liberty p. 138 (139)
- Linea p. 122
- Oliva p. 120
- Ovale p. 106 (114)
- Plastic-X p. 46
- Professional p. 106 (115)
- Quadra p. 116
- Step p. 134
- UPDATE** Stylus p. 34
- Tonda p. 106 (107)
- Venice p. 138 (143)
- Verona p. 138 (142)
- Ypsilon p. 20 (21/28)
- Ypsilon 4 p. 20 (22)
- Zenith p. 48

Tavoli - Tables

- Aero p. 214
- UPDATE** Arki-Table p. 144
- Code p. 240
- Exteso p. 224
- NEW** Fabbrico p. 154
- Jump p. 166
- UPDATE** Kuadro p. 180
- NEW** Desk p. 184
- Logico p. 180 (186)
- Low Tables p. 236
- Magic p. 190 (191)
- Malmö p. 218
- Matrix
 - Matrix p. 200 (201)
 - Consolle p. 200 (208)
 - UPDATE** Desk p. 200 (210)
 - Outdoor p. 200 (212)
- More p. 158
- NEW** Parenthesis p. 242
- Plano p. 234
- NEW** Plano2 p. 232
- Serif p. 162
- Set Pocket p. 238
- Side Table p. 237
- Snow p. 164
- Space p. 190 (196)
- Surface p. 224 (228)
- Togo p. 172
- Wow p. 244
- Finiture legno p. 251
 - Wooden finishes
- Finiture metallo p. 246
 - Metal finishes



Design Pio e Tito Toso



Le altezze dei basamenti indicate non sono comprensive dei ripiani. - Table bases heights do not include table tops.

Ikon parla il linguaggio dell'architettura con la sua massima semplicità e grande pulizia formale che pare uscire dai meandri del tempo. Coffee table, dining table o poseur table, si inserisce con facilità negli ambienti contract. With its timeless and clean shape, Ikon talks the architecture language. Coffee table, dining table or poseur table, it fits easily in contract environments.





Il basamento Ikon altezza 710 mm in polipropilene stampato a iniezione è abbinabile a ripiani in stratificato o acciaio verniciato per outdoor, vetro per indoor. Proposto nei colori bianco, nero, grigio chiaro, sabbia e beige.
 Ikon height 710 mm injected polypropylene table base can be combined with solid laminate or powder coated steel top for outdoor use, glass top for indoor use. Colours: white, black, light grey, sand and beige.



colori / colours:



BI



GC



NE
Solo per
utilizzo interno
For indoor use
only



SA



BE







Ikon con zavorra in polipropilene e cemento con piedini regolabili, abbinabile a ripiani di grandi dimensioni, garantisce grande stabilità soprattutto in ambienti esterni.
Ikon, with the addition of the ballast made of polypropylene and concrete, with adjustable feet, can be combined with large dimension tops, ensuring great stability especially in outdoor environments.





Il basamento Ikon altezza 460 mm è in polipropilene stampato a iniezione. Finiture disponibili: bianco, sabbia, beige, grigio chiaro e nero in abbinamento a ripiani in stratificato oppure bianco e nero in abbinamento a ripiani in vetro per indoor. Ikon con base Ø550 mm, in polietilene rotazionale da zavorrare, si abbina a ripiani dalle dimensioni generose in laminato oppure mdf laccato.

Ikon height 460 mm injected polypropylene table base. Finishes available: white, sand, beige, light grey and black combined with solid laminate tops or white and black combined with glass tops for indoor use. Ikon with Ø 550 mm rotomoulded polyethylene base, to be filled, can be equipped with laminate or mdf lacquered tops in larger sizes.



863V





Ikon altezza 1060 mm è il tavolo alto ideale per i bar all'aperto, per buffet e soluzioni catering. In polietilene rotazionale, è disponibile anche nella versione luminosa nella finitura bianco opalino.
Ikon poseur table height 1060mm, the ideal solution for outdoor bar, buffet and catering solutions. In rotomoulded polyethylene. Luminous version also available in white opaline finish.



868



Laja

Design Alessandro Busano

Colonna / Column Ø 50

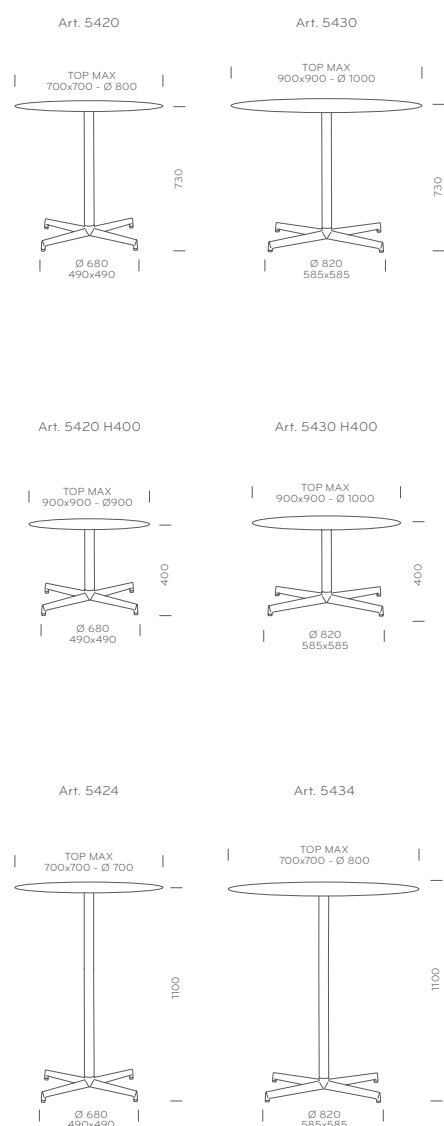

Le altezze dei basamenti indicate non sono comprensive dei ripiani. - Table bases heights do not include table tops.





Laja ha base a 4 razze in pressofusione di alluminio, finitura lucida o verniciata, e colonna in tubo d'acciaio, finitura cromata o verniciata. Disponibile nelle altezze: 400 mm, 730 mm, 1100 mm. Ideale sia per ambienti indoor che outdoor nella versione total white.

Laja table has 4 spokes die-casted aluminium base in polished or powder coated finish and steel tube column in chromed or powder coated finish. 3 heights available: 400 mm, 730 mm, 1100 mm. Perfect either for indoor and outdoor use in white full colour version.



5420_RU



5430_BIE



5430H_400_NERO

20 Ypsilon - Ypsilon 4

Design Jorge Pensi Design Studio

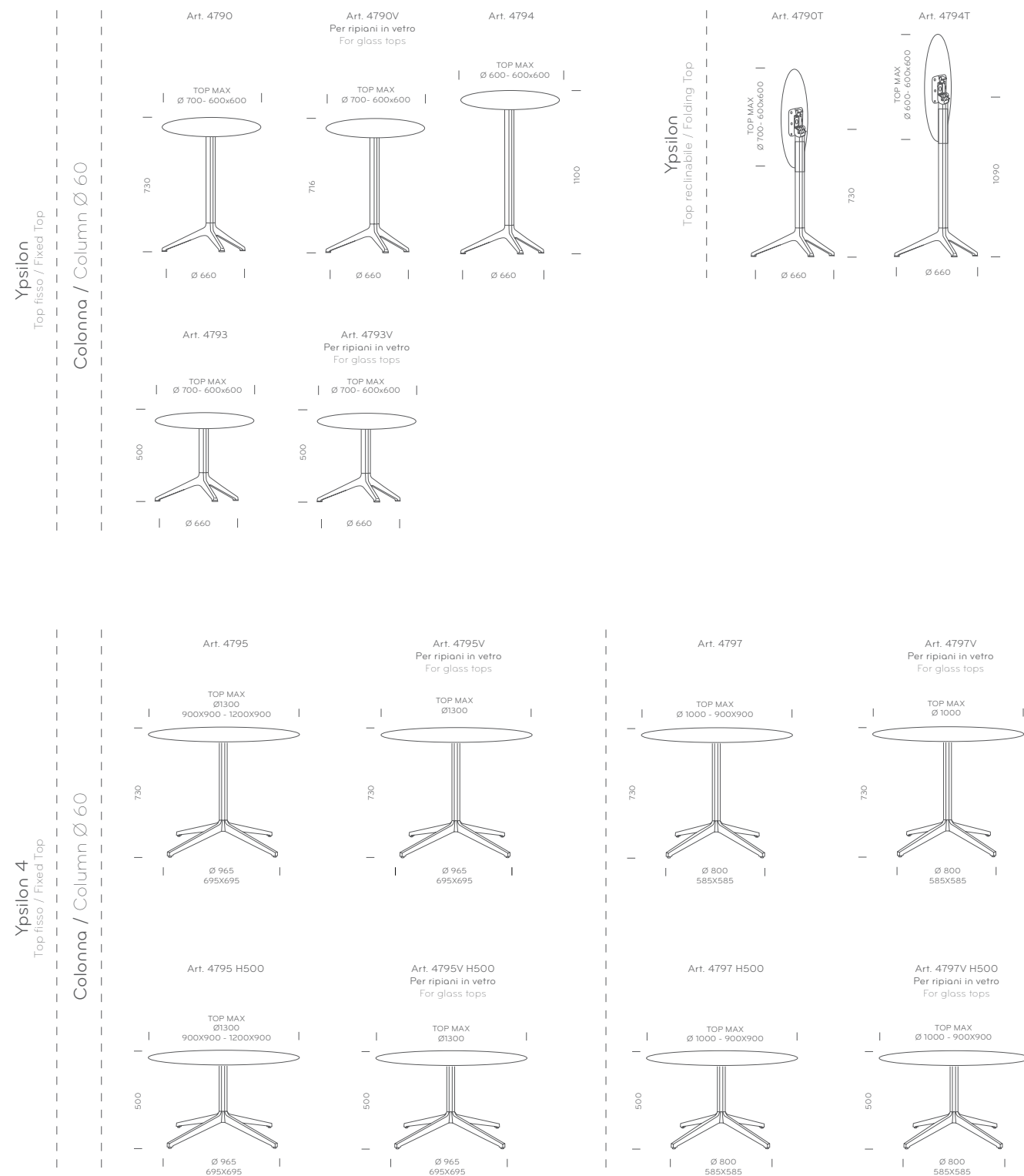

Le altezze dei basamenti indicate non sono comprensive dei ripiani. - Table bases heights do not include table tops.

21

Linee pulite e forme aeree per i basamenti Ypsilon e Ypsilon 4 rispettivamente a tre e quattro razze. Leggeri e funzionali, adatti sia per ambienti indoor che outdoor, hanno base in pressofusione di alluminio e colonna in estruso di alluminio dalla sezione ricercata. Clear outlines and light shape for Ypsilon and Ypsilon 4 tables bases, three or four spokes. Lightweight and functional, suitable for indoor and outdoor locations, they have die-casted aluminium base and extruded aluminium column with refined shape.



4790

PEDRALI DYNAMIC DESIGN

22 Ypsilon 4

Ypsilon con base a 4 razze dall'ampio diametro di appoggio è abbinabile a ripiani di grandi dimensioni sia tondi che quadrati. Proposto nella finitura lucida o verniciata, è disponibile anche nella versione con piastra per ripiano in vetro (Art. 4795V).
Ypsilon with four spokes has large diameter support that makes it suitable for tops of big dimensions either square and round. In polished or powder coated aluminium finish, it is also available with plate for glass tops (Art. 4795V).



4795_NERO



24 Ypsilon 4

Ypsilon 4 è anche coffee table nella versione altezza 500 mm, in alluminio lucidato o verniciato.
Ypsilon 4 coffee table version height 500 mm, in polished or powder coated aluminium finishes.



4795/LU



4795H_500

26 Ypsilon 4

Ypsilon a 4 razze con base Ø800 mm. Stessa tecnologia al servizio della massima funzionalità. Due le altezze disponibili: 730 mm (Art. 4797) e 500 mm (Art. 4797H_500). In alluminio lucidato, verniciato o verniciato per esterno.

Ypsilon with Ø800 mm four spokes base. The same technology for maximum functionality. Two heights available: 730 mm (Art. 4797) and 500 mm (Art. 4797H_500). In polished, powder coated or powder coated for outdoor aluminium finishes.



4797/LU



28 Ypsilon

Il basamento Ypsilon a 3 razze ha base in pressofusione di alluminio, colonna in estruso di alluminio e piedini in pvc trasparenti. Tre le altezze disponibili: 730 mm (Art. 4790), 500 mm (Art. 4793), 1100 mm (Art.4794). Ypsilon è proposto in alluminio lucidato, anodizzato o verniciato. Disponibili anche le versioni con piastra per ripiani in vetro (Art. 4790V e 4793V).
Ypsilon table base, die-casted aluminium base, extruded aluminium column and transparent pvc glides. Three heights: 730 mm (Art. 4790), 500 mm (Art. 4793), 1100 mm (Art. 4794). Ypsilon is available in polished, anodized or powder coated aluminium finish. Versions with special plate for glass tops also available (Art. 4790V and 4793V).

29



4790V/LU



4794/AA

30 Ypsilon



Grazie al meccanismo per ripiano reclinabile Ypsilon diventa accatastabile. Disponibile sia nella versione altezza 730 mm (Art. 4790T) che nella versione altezza 1090 mm (Art. 4794T).
Ypsilon becomes a nesting table thanks to special mechanism for folding top. Available versions: height 730 mm (Art. 4790T) and height 1090 mm (Art. 4794T).



4790/AA



4790T



4790T/AA



4790_BI

Tavolo Ypsilon in versione monocromatica. Basamento verniciato bianco abbinato a ripiano in stratificato Compact Full Colour oppure basamento verniciato nero abbinato a ripiano in vetro temperato laccato nero.

Ypsilon table base, monochromatic version. White powder coated base with white compact full colour top or black powder coated base with tempered glass top, black laquered.



4790V_NERO

Design Pedrali R&D

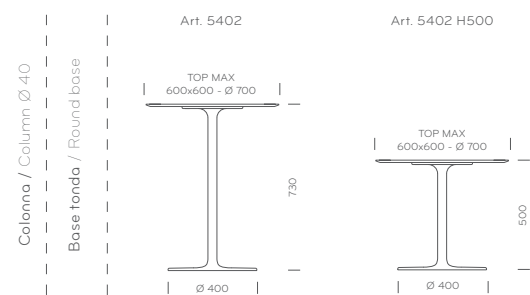
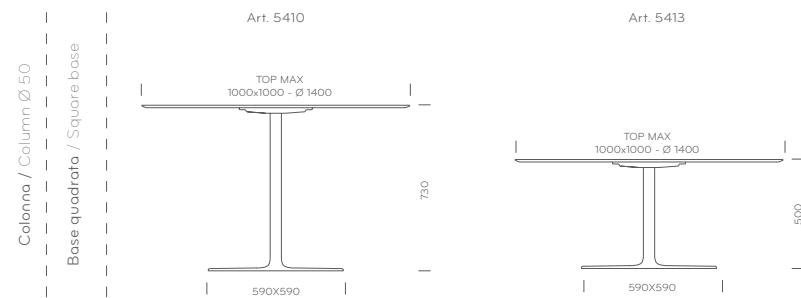
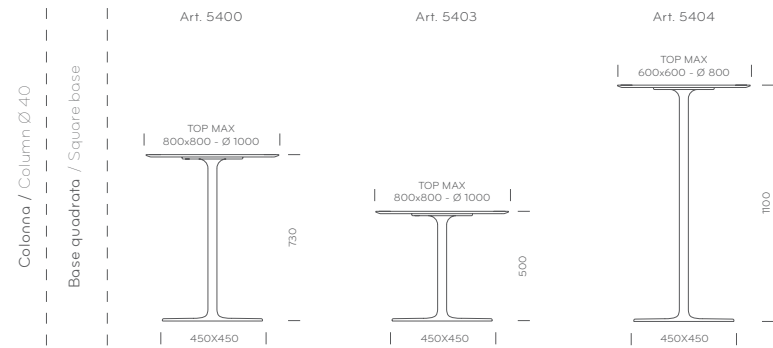

Le altezze dei basamenti indicate non sono comprensive dei ripiani. - Table bases heights do not include table tops.



36 Stylus

Il basamento Stylus si contraddistingue per il suo look minimal e per le sue linee organiche, grazie alla sottile colonna centrale e agli angoli raggianti della base quadrata. Molto stabile, è adatto sia per ripiani quadrati che rotondi.
Stylus table base stands out for its minimalistic look and organic outline, thanks to the slim central column and to the rounded corners of its flat square base. Very stable, it is suitable for both square and round table tops.

37



5400_NERO



5402_BI

5402_NERO

38 Stylus

Stylus è disponibile anche nella versione altezza 1100 mm (Art. 5404), ideale per le situazioni più dinamiche degli ambienti contract.
Stylus is available also in height 1100 mm (Art. 5404), ideal for dynamic public spaces.



5400_BI



5404_BI

40 Bold

Design Pedrali R&D

Colonna / Column Ø 50

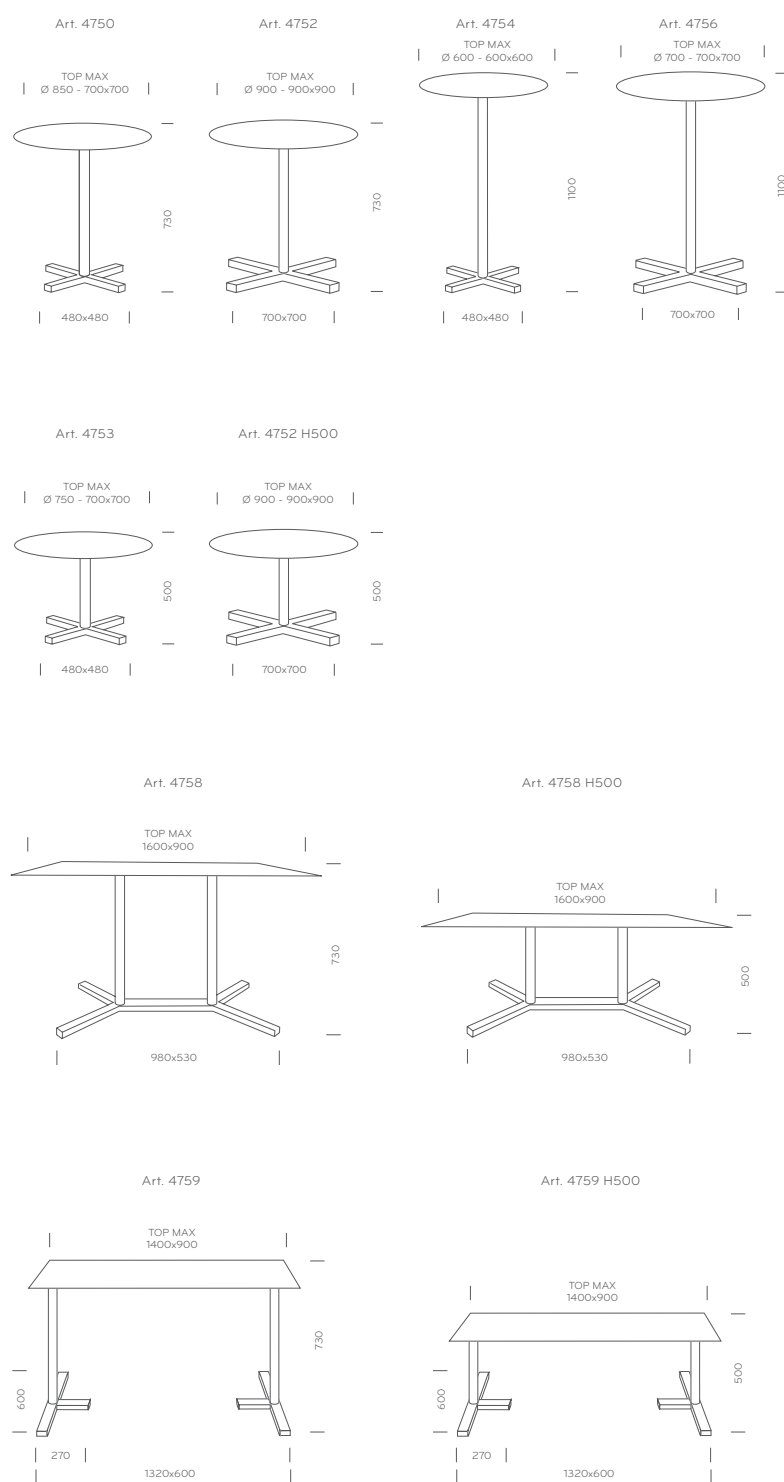

Le altezze dei basamenti indicate non sono comprensive dei ripiani. - Table bases heights do not include table tops.



Tavolo Bold (Art. 4750_BIE) con ripiano in stratificato Compact Full Colour e sedie Gossip.
 Bold table (Art. 4750_BIE) with Compact Full Colour solid laminate top and Gossip chairs.



Tavolo Bold, base in fusione di ghiso, colonna in tubo Ø 50 mm. Verniciato vari colori: bianco, nero, alluminio, grigio naturale, marrone, avorio ed alluminio per esterni.
 Bold table, cast-iron base, tube column Ø 50 mm. Powder coated in the following colours: white, black, silver, natural grey, brown or ivory or powder coated for outdoor use.



Piedini regolabili.
 Adjustable feet.



4754

4752

44 Bold

Tavolo Bold versione per ripiani rettangolari con base in fusione di ghisa e doppia colonna in tubo Ø 50 mm. Verniciato nei colori: nero, bianco, alluminio, grigio naturale, marrone, avorio ed alluminio per esterni. Piedini regolabili.
Bold table, cast-iron base, two tube columns Ø 50 mm. Powder coated in the following colours white, black, silver, natural grey, brown or ivory or powder coated for outdoor use. Adjustable feet.



4758

Tavolo Bold versione per ripiani rettangolari con basi in fusione di ghisa e colonne in tubo Ø 50 mm, accostabili tra loro garantendo il minimo ingombro. Verniciato nei colori: nero, bianco, alluminio, grigio naturale, marrone, avorio ed alluminio per esterni. Piedini regolabili.
Bold table, rectangular tops version with cast-iron bases and tube Ø 50 mm, once they are lined up can grant the minimal overall dimensions. Powder coated colours: black, white, aluminium, natural grey, brown, ivory and aluminium for outdoor use, provided with adjustable feet.



Esempio di Bold affiancati.
Example of lined up Bold tables.



4759

46 Plastic-X

Design Pedrali R&D

Tavolo Plastic-X (Art. 4740) con ripiano in polietilene e sedie Ice.
Plastic-X table (Art. 4740) with polyethylene top and Ice chairs.



Base in acciaio ricoperta di polipropilene, colonna in tubo di acciaio Ø 50 mm, finitura per esterno.
Steel base, polypropylene moulded, steel tube column Ø 50 mm, outdoor finish.

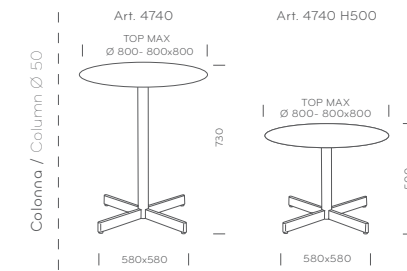

Le altezze dei basamenti indicate non sono comprensive dei ripiani.
Table bases heights do not include table tops.



Piedini regolabili.
Adjustable feet.



4740

48 Zenith

Design Pedrali R&D

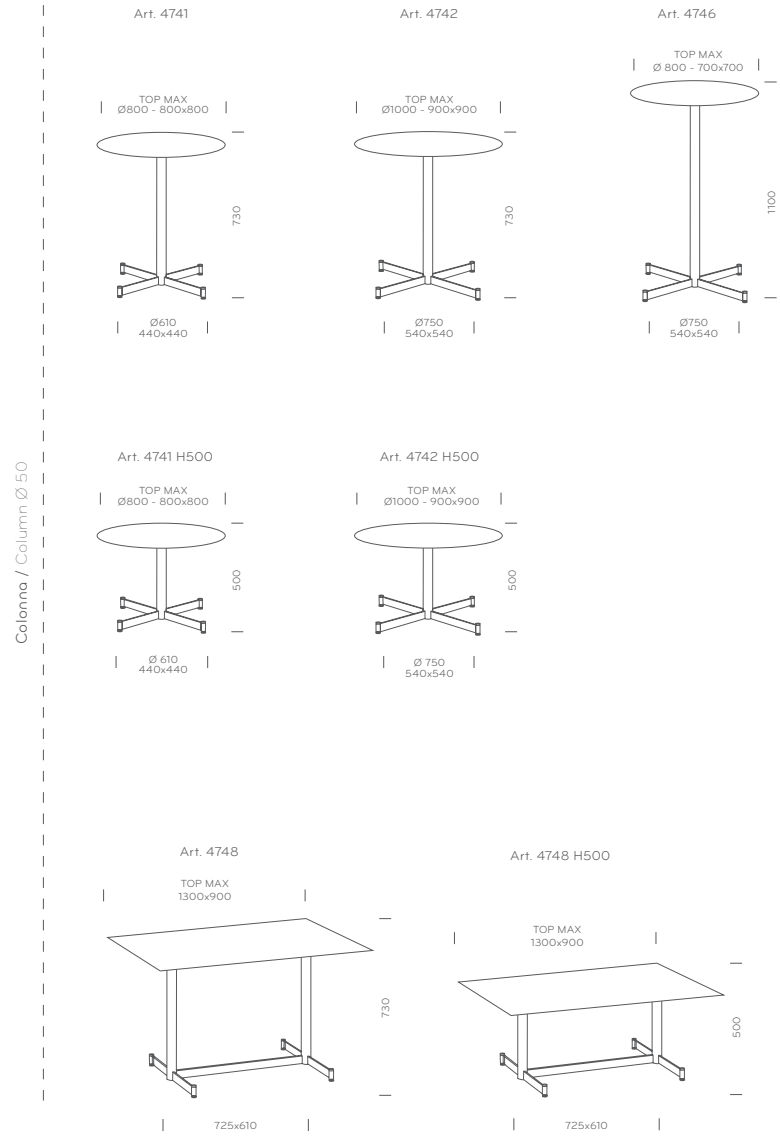

Basamento Zenith, base e colonna in acciaio inox satinato, piedini regolabili in fusione di alluminio satinato.
Zenith Table base, stainless steel base and column, cast aluminium adjustable feet.



Piedini regolabili.
Adjustable feet.



4742/AC

Le altezze dei basamenti indicate non sono comprensive dei ripiani. - Table bases heights do not include table tops.



52 Krystal

Design Pedrali R&D

Base in acciaio inox lucidato o satinato. Colonna conica in metacrilato trasparente, bianco lucido, nero lucido o oro metallizzato con tubo portante in acciaio cromato.
Brushed or polished stainless steel base, methacrylate column, transparent, glossy white, glossy black or metallic gold with chromed steel central tube.

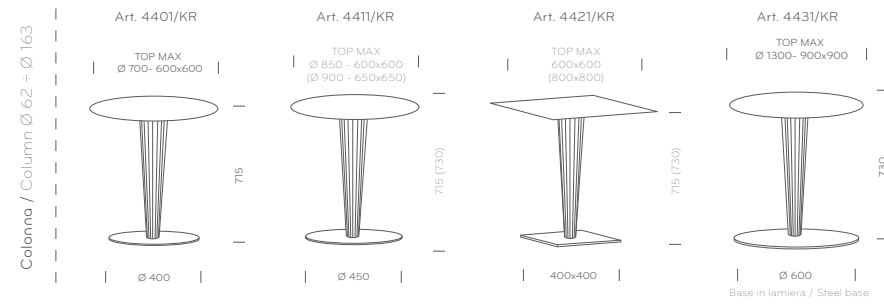

Le altezze dei basamenti indicate non sono comprensive dei ripiani.
Table bases heights do not include table tops.

Tavolo Krystal con colonna trasparente e ripiano in vetro temperato nero. Sedia Queen.
Krystal table with transparent column and black tempered glass top. Queen chair.

finiture colonna:
column finishes:

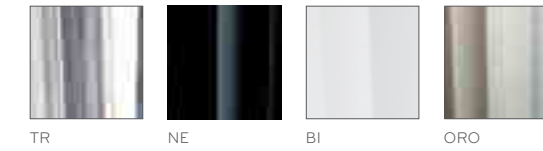

4421/KRBI



4421/KRTR



56 Krystal



4431/KRTR

Basamento Krystal con colonna conica in metacrilato trasparente e tubo portante in acciaio cromato. Base in acciaio inox lucidato o satinato con piedini regolabili a richiesta. Ripiano in compact full colour bianco.
Krystal table base, transparent methacrylate column and chromed steel central tube. Brushed or polished stainless steel base, adjustable feet on request. White compact full colour top.

57

58 Inox con colonna Ø 50 mm e 50x50 mm

Design Pedrali R&D

Colonna / Column Ø 50

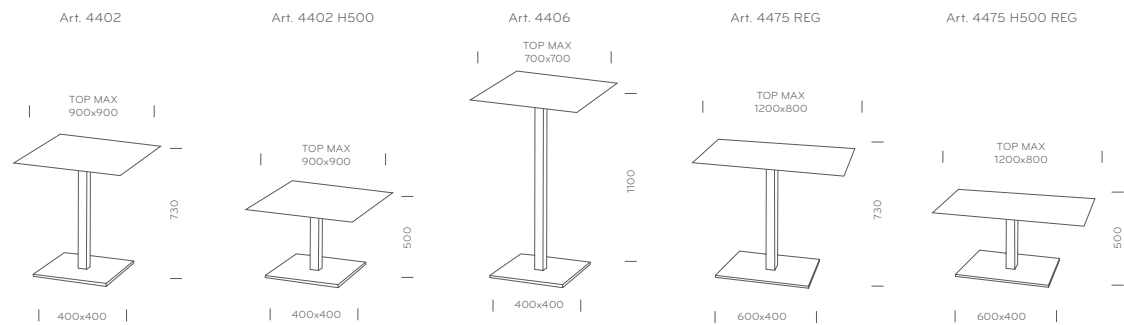
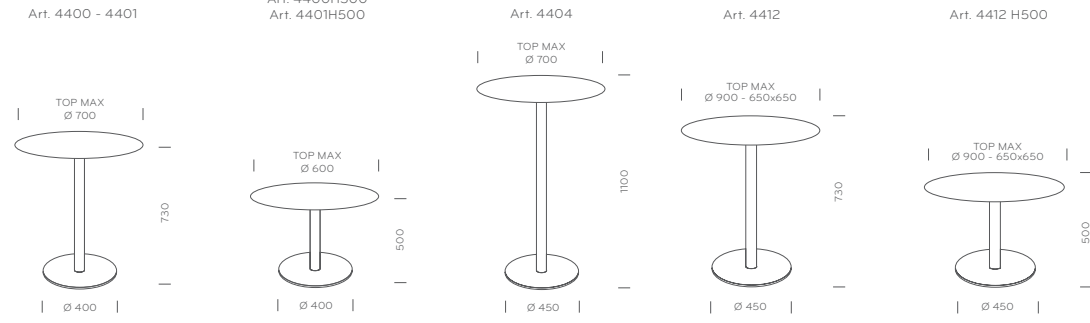

Colonna / Column 50x50

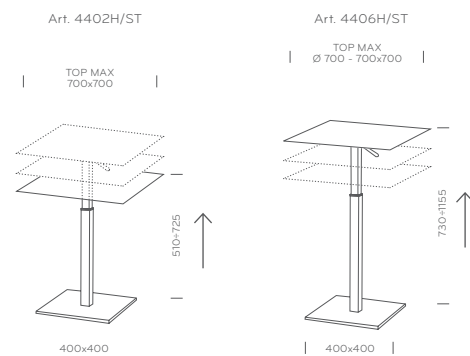
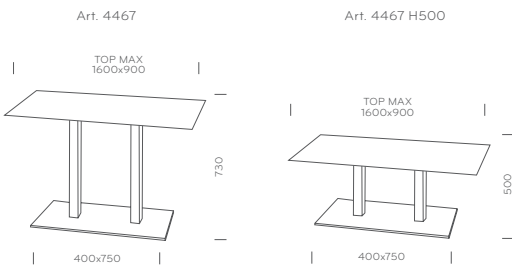

Le altezze dei basamenti indicate non sono comprensive dei ripiani. - Table bases heights do not include table tops.

Tavolo Inox (Art.4402/AC) base da 400x400 mm e colonna 50x50 mm, in acciaio inox satinato con ripiano impiallacciato rovere tinto wengé. Sedie Gossip.
Inox table brushed stainless steel base 400x400 mm, column 50x50 mm with oak veneered stained wenge top. Gossip chairs.



Basamenti Inox con colonna e copribase nelle finiture ottone anticato, rame anticato, bronzo anticato ed effetto corten. Ripiani in laminato o stratificato.
Inox table bases with column and cover-base in antique brass, antique copper, antique bronze or corten finishes. Laminated or solid laminated tops.



4401/BS



4401/RM



4401/OA



4402/EC

Basamenti Inox in acciaio inox satinato (Art. 4401/AC) o inox lucidato (Art. 4401/LU) con colonna da Ø 50 mm. Ripiani in vetro temperato laccato bianco o nero.
 Inox table bases, brushed stainless steel (Art. 4401/AC) and polished stainless steel (Art. 4401/LU) with Ø 50 mm column. Tempered glass tops, white or black laquered.



4401/AC

4401/LU

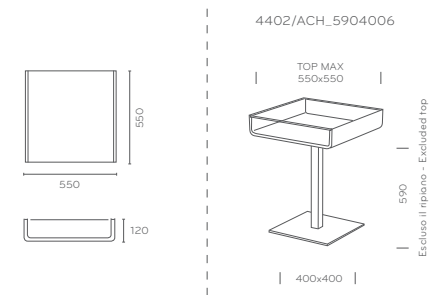

Basamento in acciaio inox satinato. Ripiano multifunzionale laccato bianco con vetro trasparente. Disponibile anche nella versione altezza 500 mm.
 Inox table base, brushed stainless steel. White laquered multifunctional top, brushed stainless steel. White laquered multifunctional top. Version height 500 mm also available.



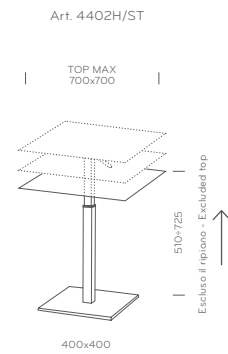

4402H/ST Dining Table

Tavolo Inox in acciaio inox satinato regolabile in altezza con meccanismo di alzata a gas azionato mediante leva sulla colonna; da tavolo pranzo (altezza 725 mm) diviene coffee table (altezza 510 mm). Sedie Mya e poltrona Box lounge.
Inox table, brushed stainless steel, adjustable in height with gas lift device with lever on the column; from dining table (height 725 mm), it becomes coffee table (height 510 mm). Mya chairs and Box Lounge armchair.



4402H/ST Coffee Table

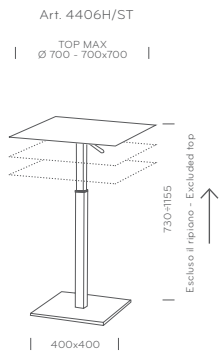

4406H/ST Poseur Table

Tavolo Inox regolabile in altezza con meccanismo di alzata a gas azionato mediante leva sulla colonna; da tavolo da pranzo (altezza 730 mm) diviene tavolo alto (altezza 1155 mm). Sgabelli e sedie Kuadra.
 Inox table adjustable in height with gas lift device with lever on the column; from dining table (height 730 mm), it becomes poseur table (height 1155 mm). Kuadra bar stools and chairs.



4406H/ST Dining Table

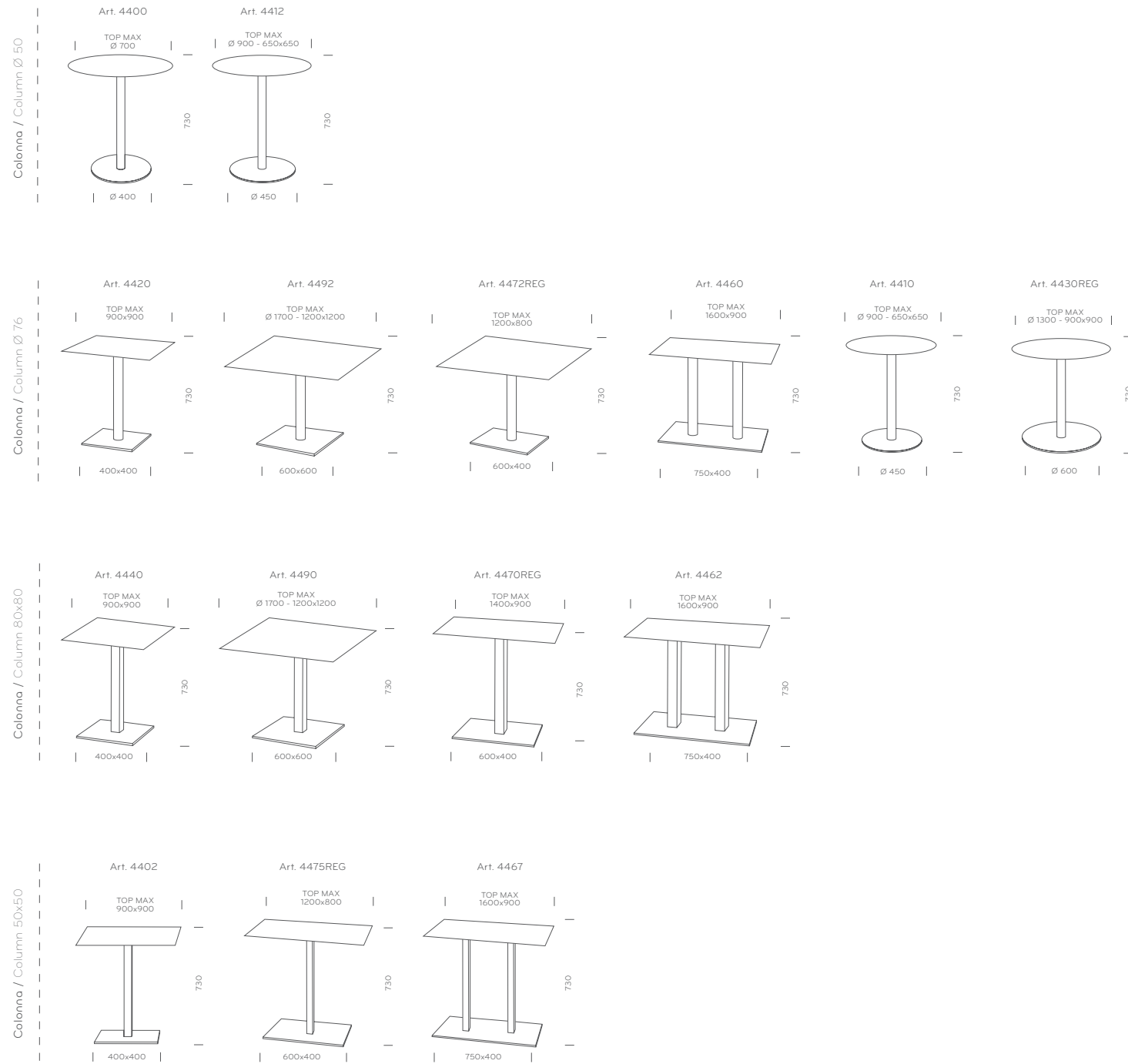

Le altezze dei basamenti indicate non sono comprensive dei ripiani. - Table bases heights do not include table tops.

4400_AG

4402_BI

Inox colonna Ø 76 mm e 80x80 mm base quadrata e rettangolare

Basamento Inox (Art.4421/LU) in acciaio inox lucidato e ripiano impiallacciato rovere tinto wengé.
Inox table base (Art.4421/LU), polished stainless steel base and column, with oak veneered top stained wenge.

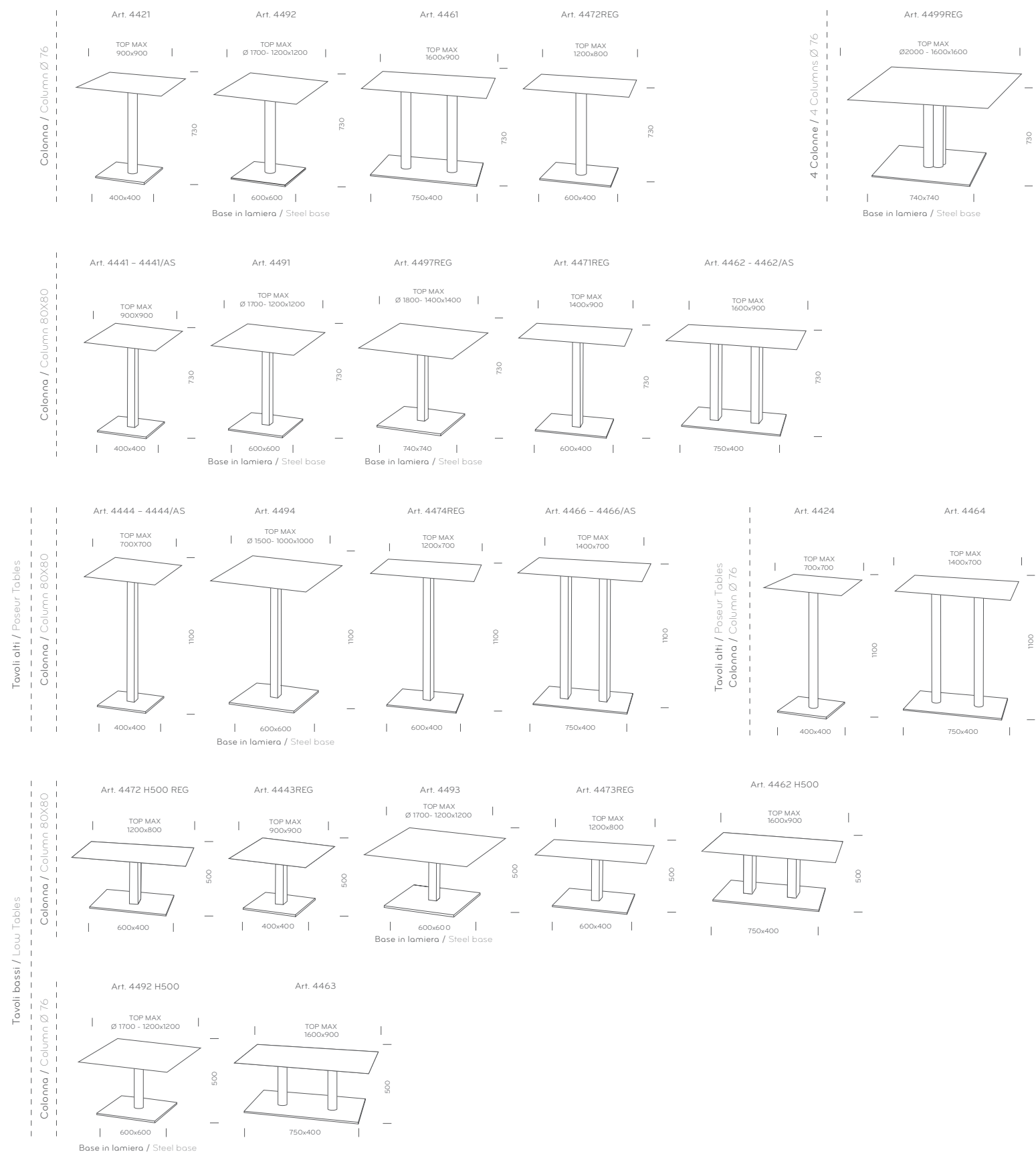

Le altezze dei basamenti indicate non sono comprensive dei ripiani. - Table bases heights do not include table tops.

Inox quadrato in acciaio inox lucidato con colonna da Ø 76 mm; disponibile la versione in acciaio inox satinato.
Square Inox table base, polished stainless steel with Ø 76 mm column; available in brushed stainless steel.



4421/LU

Basamento alto Inox (Art. 4424/LU) in acciaio inox lucidato con colonna da Ø 76 mm; disponibile la versione in acciaio inox satinato.
Inox poseur table base (Art. 4424/LU), polished stainless steel with Ø 76 mm column; available in brushed stainless steel.



Basamento Inox rettangolare in acciaio satinato con due colonne da Ø 76 mm.
Rectangular Inox table base, brushed stainless steel with Ø 76 mm columns.



4461/AC

Basamento Inox quadrato in acciaio inox satinato 400x400 mm, con colonna Ø 76 mm (Art. 4421/AC) o con colonna da 80x80 mm (Art. 4441/AC).
Inox square table base 400x400 mm, brushed stainless steel, with Ø 76 mm column (Art. 4421/AC) or with 80x80 mm column (Art. 4441/AC).



4421/AC



4441/AC

Basamento Inox rettangolare in acciaio inox satinato con colonne 80x80 mm.
Rectangular Inox table bases, brushed stainless steel, with 80x80 mm columns.



4462/AC

Basamento Inox in acciaio inox satinato, versione alta con base da 400x400 mm, e con colonna 80x80 mm.
Inox poseur table base 400x400 mm, brushed stainless steel, with 80x80 mm column.



4444/AC

Basamento Inox con base quadrata da 600x600 mm in acciaio inox satinato, o lucidato, con tubo da 80x80 mm.
Inox square table base 600x600 mm brushed or polished stainless steel, with 80x80 mm tube.



4491/AC

Basamento Inox quadrato 740x740 mm in acciaio inox satinato con tubo da 80x80 mm. Piedini regolabili.
Inox square table base 740x740 mm, brushed stainless steel, with 80x80 mm tube. Adjustable feet.



4497/ACREG

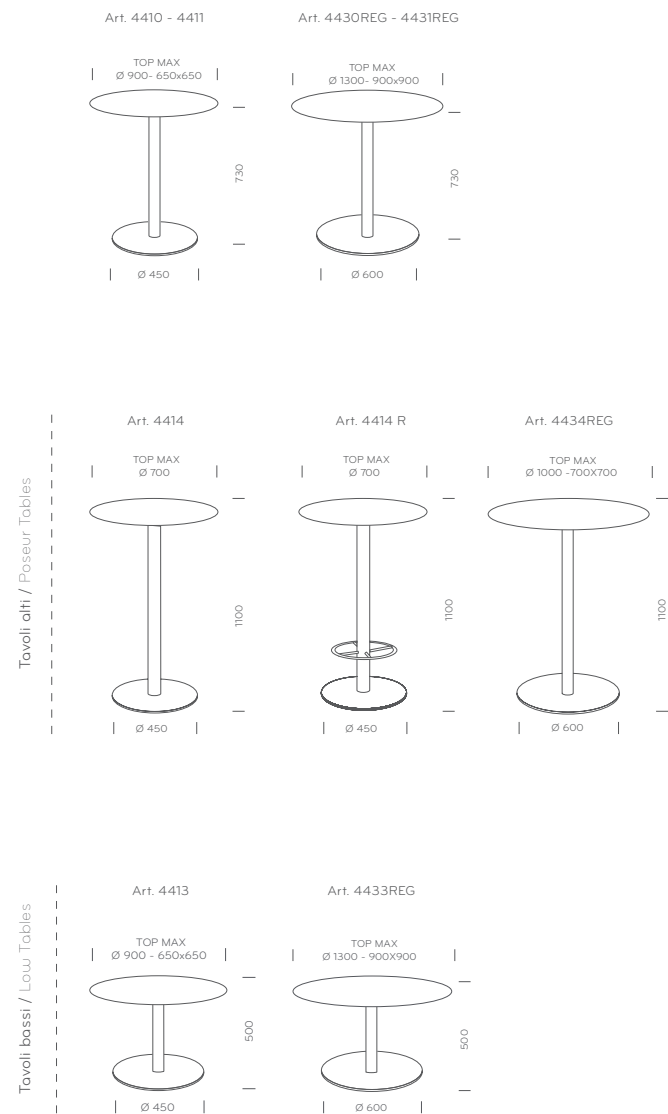

Basamento Inox con base in acciaio inox lucidato e colonna da Ø 76 mm lucidata.
Inox table base, polished stainless steel base and Ø 76 mm polished column.



4411/LU

Basamenti Inox in acciaio inox satinato con base da Ø 450 mm (Art. 4411/AC) e da Ø 600 mm (Art. 4431/ACREG), colonna in tubo da Ø 76 mm.

Inox table bases, brushed stainless steel base Ø 450 (Art. 4411/AC) and Ø 600 mm (Art. 4431/ACREG), Ø 76 mm tube column.



4411/AC

4431/ACREG

Basamenti alti Inox in acciaio inox satinato o lucidato con colonna da Ø 76 mm.
Inox poseur table bases, brushed or polished stainless steel with Ø 76 mm column.



4414/AC

Basamento Inox Permanent per il fissaggio a pavimento. Base Ø 220 mm disponibile nella versione cromata o in inox satinato.
Inox Permanent table base fixable to the floor. Base Ø 220 mm available in chromed finish or in brushed stainless steel finish.

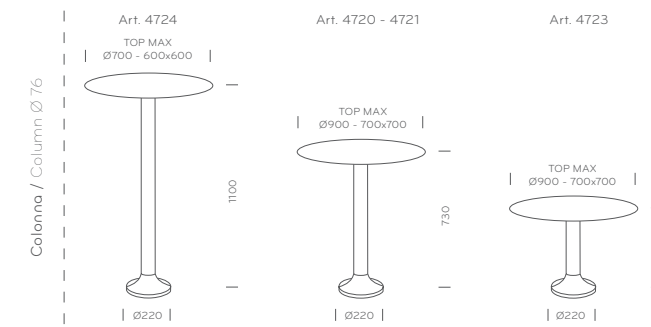

Le altezze dei basamenti indicate non sono comprensive dei ripiani.
Table bases heights do not include table tops.



4721/CR

Versione Permanent con base Ø 280 mm, in acciaio inox satinato o lucidato.
Permanent with brushed or polished stainless steel base Ø 280 mm.

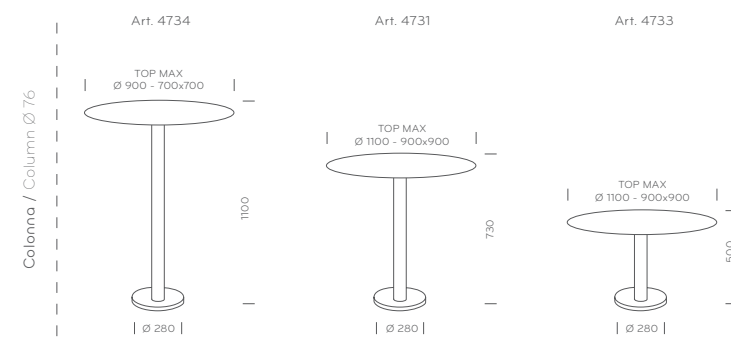

Le altezze dei basamenti indicate non sono comprensive dei ripiani.
Table bases heights do not include table tops.



4731/AC



Da fissare a pavimento.
To be fixed to the floor.

Permanent con base quadrata 200x200 mm e colonna quadrata disponibile in due diverse dimensioni: 50x50 mm (Art. 4738/AC) e 80x80 mm (Art. 4739/AC). Da fissare a pavimento.

Permanent with square base 200x200 mm and square column available in two different dimensions: 50x50 mm (Art. 4738/AC) and 80x80 mm (Art. 4739/AC). To be fixed to the floor.

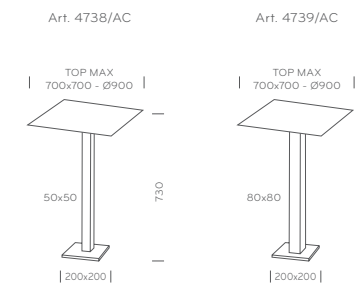

Le altezze dei basamenti indicate non sono comprensive dei ripiani.
Table bases heights do not include table tops.



4738/AC

Tavolo Inox ellittico con base in acciaio inox satinato.
Disponibile versione coffee table (Art. 4903) e dining table (Art. 4901).
Elliptical Inox table with brushed stainless steel base.
Available coffee table (Art. 4903) and dining table (Art. 4901).

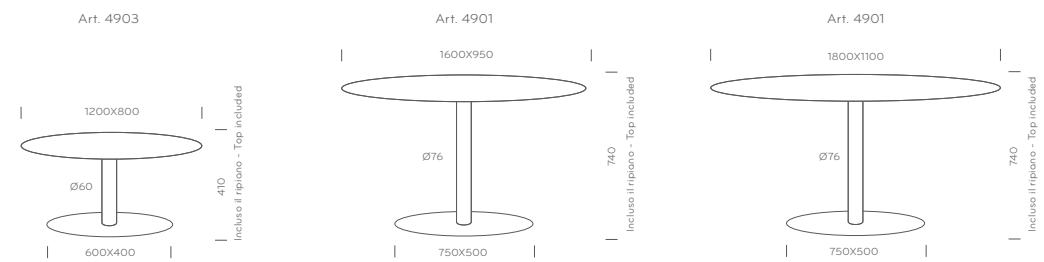

4903/AC

Tavolo Inox ellittico (Art. 4901/AC) con ripiano in stratificato Compact Full Colour e sedie Trend.
Inox elliptical table (Art. 4901/AC) with Compact Full Colour solid laminate top and Trend chairs.



Basamento Inox con base e fascia in acciaio inox satinato; colonna in faggio massello tinto wengé.
 Inox table base, brushed stainless steel base and collar, wenge stained solid beech column.

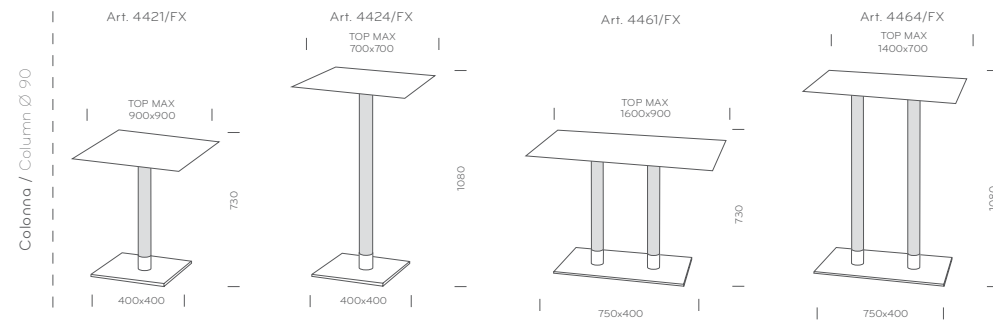

Le altezze dei basamenti indicate non sono comprensive dei ripiani.
 Table bases heights do not include table tops.



4421/FX_AC

Basamenti Inox con base e fascia in acciaio inox e colonne in faggio massello.
 Ripiani in vetro temperato fissati al basamento mediante piastra in acciaio inox.
 Inox bases table with stainless steel base and band, solid beech wood columns.
 Tempered glass tops fixed to the table base with a stainless steel plate.

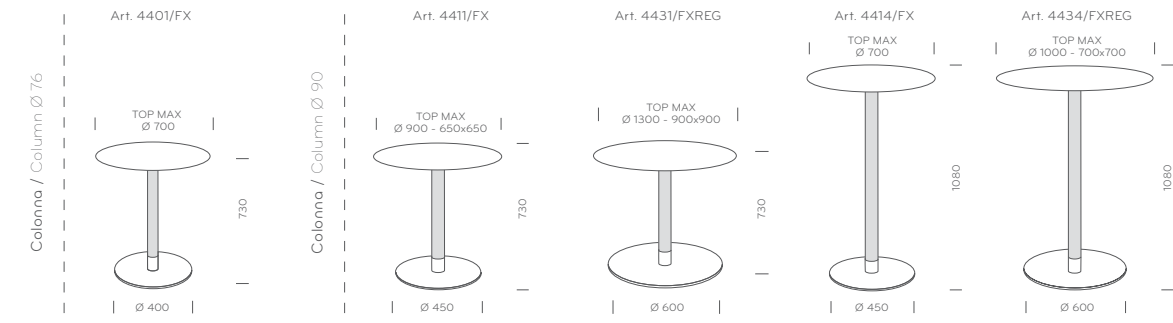

Le altezze dei basamenti indicate non sono comprensive dei ripiani.
 Table bases heights do not include table tops.



4411/FX_AC



4401/FX_LU

Basamento Inox con base in acciaio inox satinato e lucidato e collarino in alluminio satinato. Colonna 80x80 mm in faggio massello tinto wengé.
 Inox table base, brushed and polished stainless steel base and satinized aluminium collar. Wenge stained solid beech column 80x80 mm.

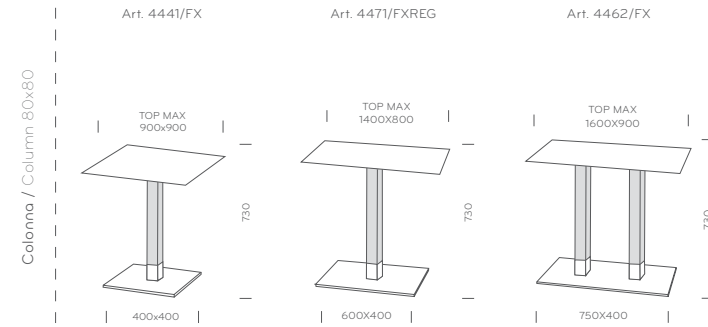

Le altezze dei basamenti indicate non sono comprensive dei ripiani.
 Table bases heights do not include table tops.



4441/FX_AC



4462/FX_AC

Basamento Inox, base in acciaio inox satinato o lucidato, colonna impiallacciata di rovere, sbiancato o tinto wengè.
 Table base Inox, brushed or polished stainless steel base, oak veneered column, bleached oak or wenge stained.

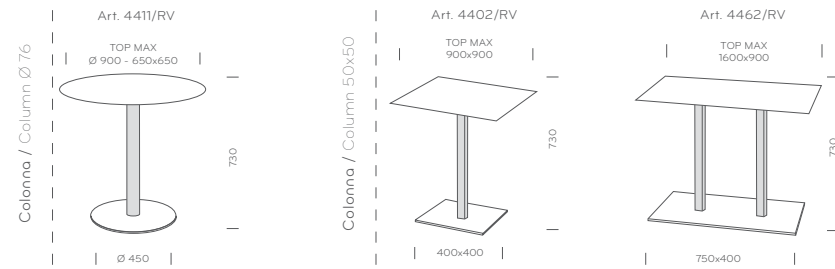

Le altezze dei basamenti indicate non sono comprensive dei ripiani.
 Table bases heights do not include table tops.



4411/RVRS

Basamento Inox (Art. 4402/RVRS) con colonna impiallacciata in rovere sbiancato e ripiano inox. Sedia Feel.
 Inox table base (Art. 4402/RVRS) with bleached oak veneered column and stainless steel top. Feel chair.



Design Pedrali R&D

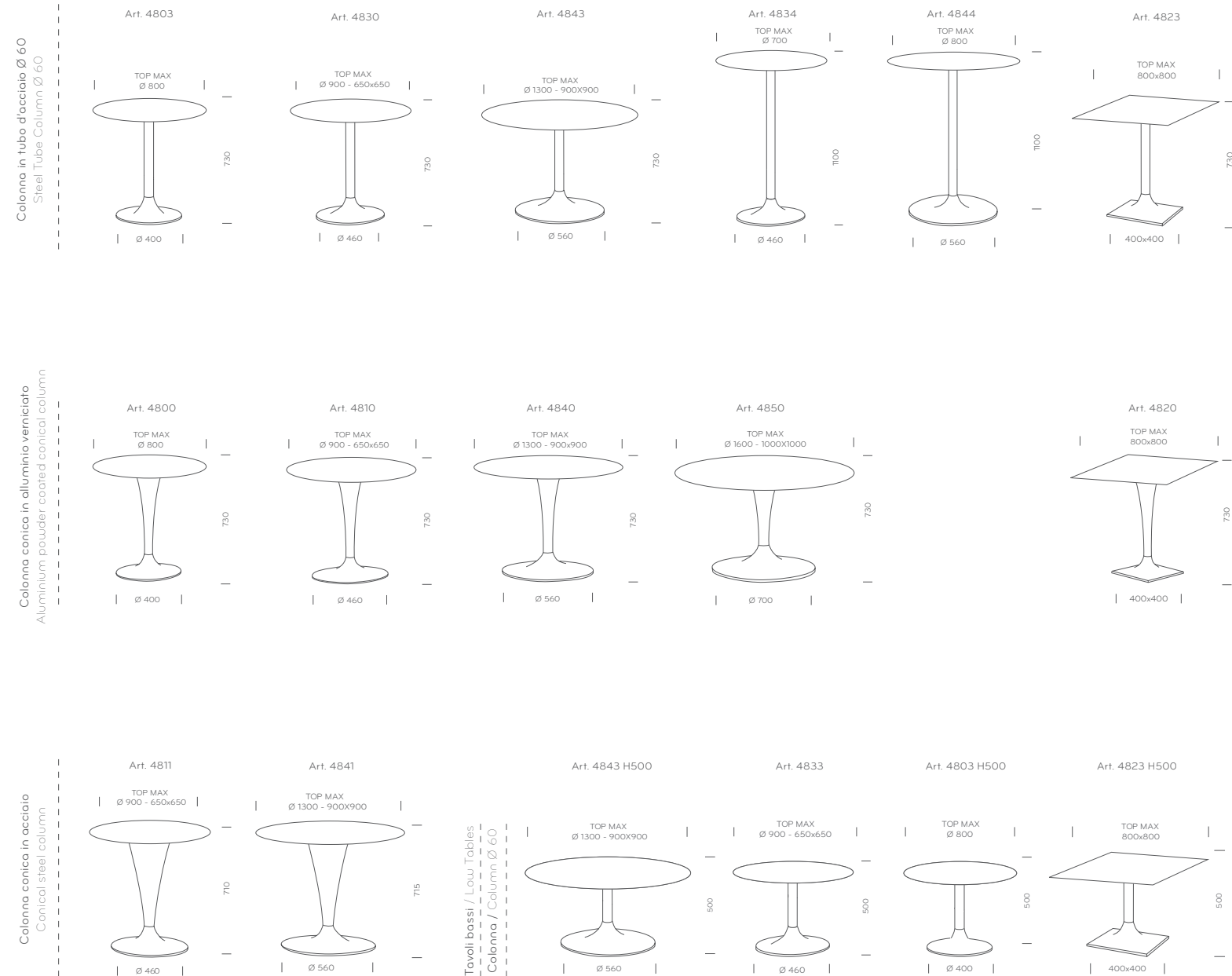

Le altezze dei basamenti indicate non sono comprensive dei ripiani. - Table bases heights do not include table tops.

Basamento Dream (Art. 4803/CR) con base in acciaio inox lucidato, tubo cromato. Ripiano in vetro temperato laccato nero.
Dream table base (Art. 4803/CR) polished stainless steel base, chromed steel tube. Black laquered tempered glass top.





4810



4840



4820

Basamento Dream (Art 4830_BI) con ripiano stratificato Compact Full Colour. Sedie Grace.
Dream table base (Art. 4830_BI) with Compact Full Colour solid laminate top. Grace chairs.



Basamenti Dream con base in fusione di ghisa sabbata, colonna in tubo d'acciaio, verniciato.
La base è disponibile in diverse misure.
Dream table bases, sand-blasted cast-iron base and steel tube column, powder coated.
Base is available in different sizes.



4843

4823

Basamento Dream, base in acciaio inox satinato o lucidato, colonna in tubo d'acciaio cromato o satinato.
Ripiano in vetro temperato laccato bianco o nero.
Dream table base, polished or brushed stainless steel base, chromed or satinized steel tube column.
Tempered glass top, white or black laquered.



4803/CR



4843/AC

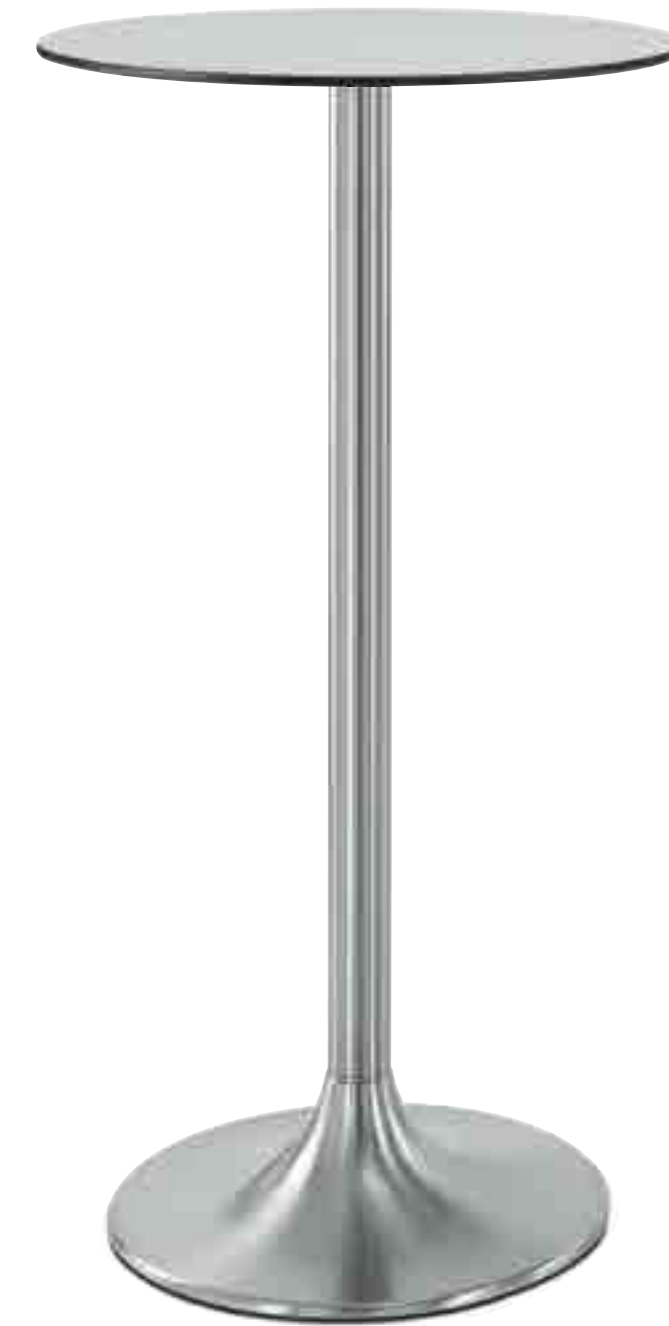

4834/AC



4844/CR

Basamenti alti Dream, base in acciaio inox satinato o lucidato, colonna in tubo d'acciaio cromato o satinato.
Dream poseur table bases, polished or brushed stainless steel base, chromed or satinized steel tube column.

Basamento Dream, base in acciaio inox satinato, colonna conica in acciaio satinato.
Disponibile anche la versione con base in acciaio lucidato e colonna cromata.
Dream table base, brushed stainless steel base, satinized steel conical column.
Available polished stainless steel base and chromed column.



4841/ST



4811/ST

Design Pedrali R&D

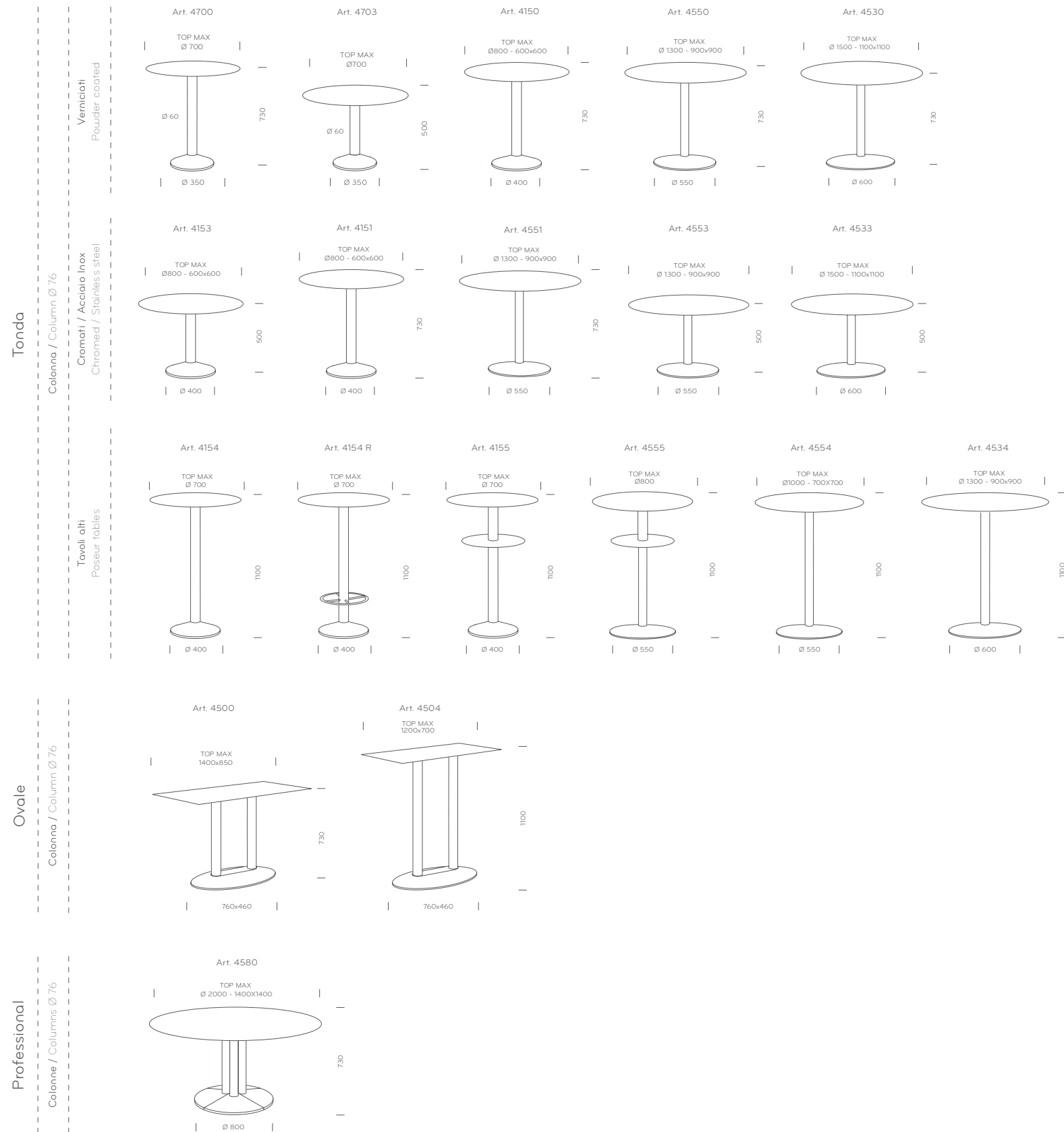

Le altezze dei basamenti indicate non sono comprensive dei ripiani. - Table bases heights do not include table tops.



4151/CR

PEDRALI DYNAMIC DESIGN

108 Tonda

Basamento Tonda alto, base e colonna in acciaio inox satinato. Ripiano in laminato bianco con bordo ABS.
Tonda poseur table base, brushed stainless steel base and column. White laminate top with ABS edge.



4154/AC

109

Basamento Tonda alto con poggiatesta sulla colonna; base in acciaio inox lucidato e colonna in acciaio cromato.
Tonda poseur table base, with foot-rest. Polished stainless steel base, chromed column and foot-rest.



4154R/CR

110 Tonda

Basamento Tonda alto in acciaio inox satinato.
Tonda poseur table base, brushed stainless steel base and column.



4554/AC

Basamento Tonda in acciaio inox satinato, fornito con piastra superiore in inox solo per ripiani in vetro.
Tonda table base, brushed stainless steel. With inox plate for glass top only.



4151/AC

112 Tonda

Basamenti Tonda, base in fusione di ghisa sabbata e colonna in tubo d'acciaio, verniciato in diversi colori. Colonna cromata o in acciaio inox satinato. Base disponibile in acciaio inox lucidato o satinato (solo per Art. 4150, 4550).
Tonda table bases, sand-blasted cast-iron base and steel tube column, powder coated in several colours. Chromed or brushed stainless steel column. Available polished or brushed stainless steel base (Art. 4150 and 4550 only).



4150/CR



4530



4550

4700

114 Ovale

Basamento Ovale, base in fusione di ghisa, sabbata e verniciata, colonne in acciaio verniciato o cromato.
Ovale table base, sand-blasted powder coated cast-iron base, with chromed or powder coated steel columns.



4500/CR

Basamento Professional, base in fusione di ghisa divisa in quattro parti, quattro colonne in tubo d'acciaio verniciato. La base è munita di ruote per agevolare lo spostamento del tavolo.
Professional table, cast-iron base in four parts, four powder coated steel tube columns. Base with wheels to facilitate the table displacement.



4580

Professional 115

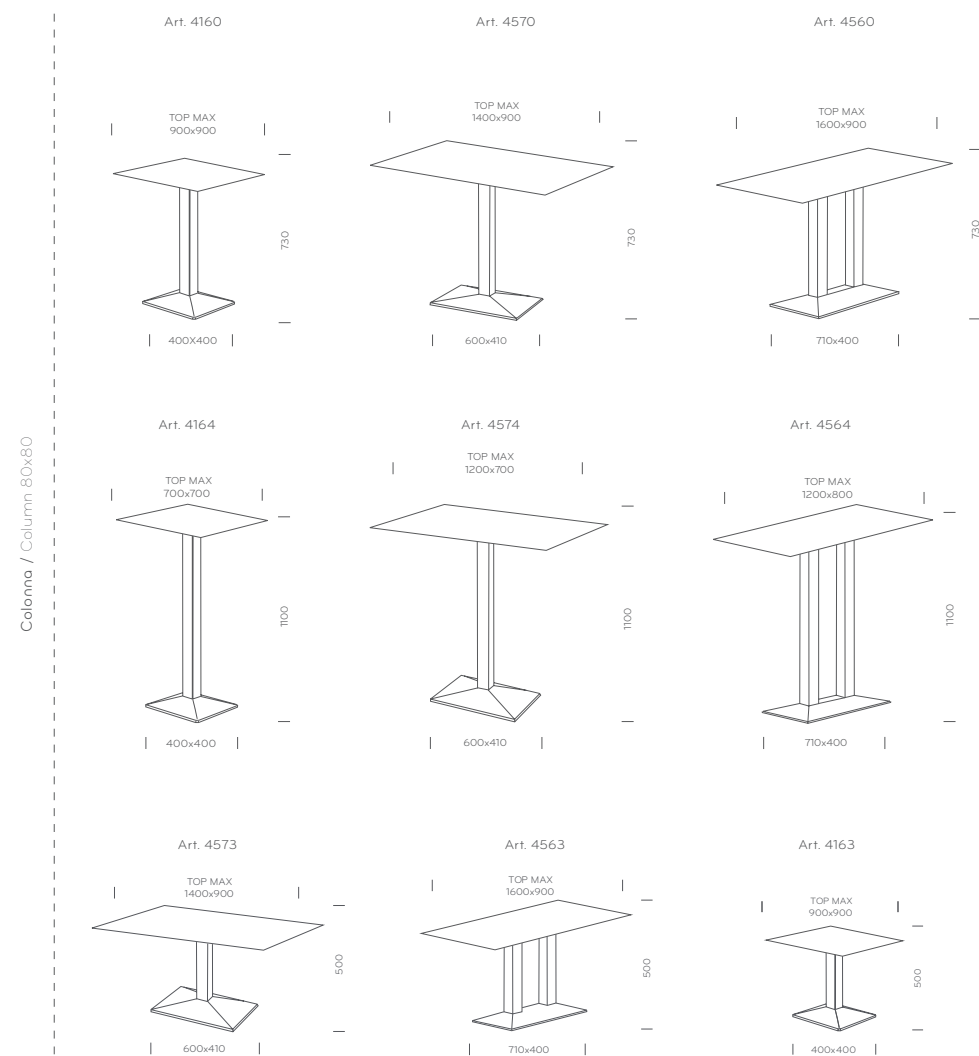

4570



4560



4160/AC



4160

Basamenti Oliva con base in acciaio inox satinato o lucidato e colonna in faggio massello.
Oliva table base, brushed or polished stainless steel base, solid beech column.

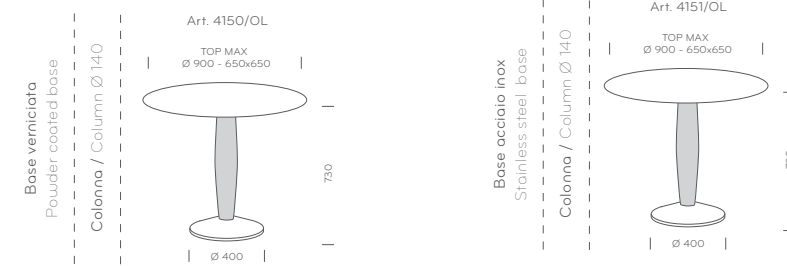

Le altezze dei basamenti indicate non sono comprensive dei ripiani.
Table bases heights do not include table tops.



4151/OL_LU



Le altezze dei basamenti indicate non sono comprensive dei ripiani.
Table bases heights do not include table tops.



4551/OL_AC

Design Pedrali R&D

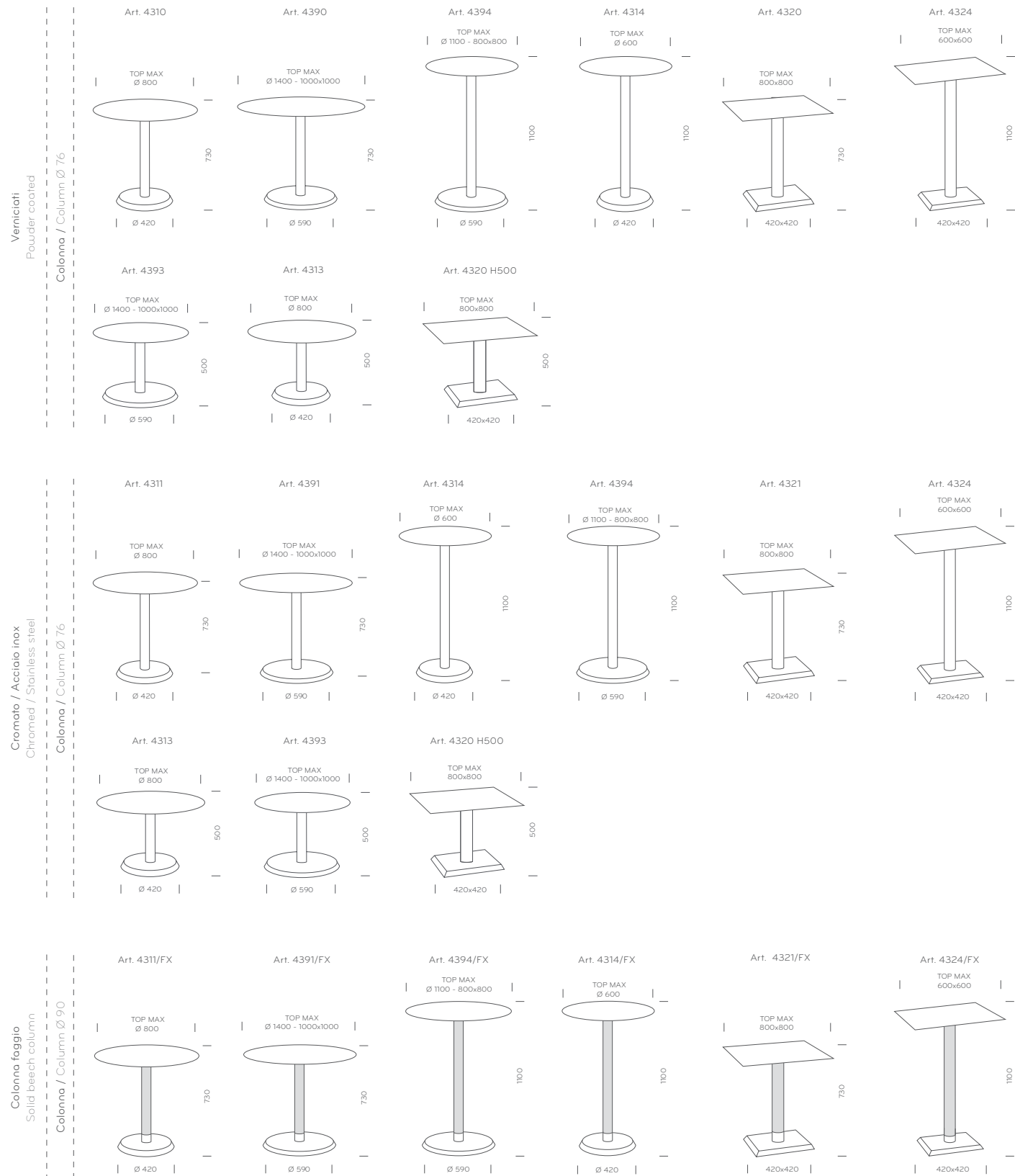

Le altezze dei basamenti indicate non sono comprensive dei ripiani. - Table bases heights do not include table tops.

Basamento Linea, base in acciaio inox lucidato, colonna in acciaio cromato.
 Disponibile anche base e colonna in acciaio inox satinato.
 Table base Linea, polished stainless steel base, chromed steel column.
 Available brushed stainless steel base and satinized column.



4311/CR

Basamento Linea, base in acciaio inox satinata o lucidata, colonna in faggio massello con collarino in acciaio.
Table base Linea, polished or brushed stainless steel base and collar, solid beech column.



4311/FX_AC



4321/FX_AC



4391/FX_AC



4311/CR

126 Freddy

Design Pedrali R&D

Basamento Freddy con tre gambe in acciaio cromato oppure verniciato.
Freddy table base with three chromed or powder coated steel legs.

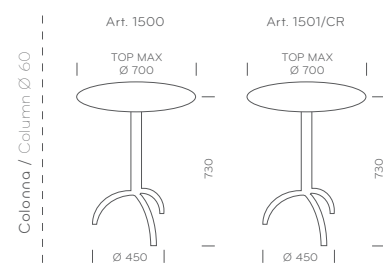

Le altezze dei basamenti indicate non sono comprensive dei ripiani.
Table bases heights do not include table tops.



1501/CR

Jimmy 127

Basamento Jimmy con quattro gambe in acciaio cromato oppure verniciato.
Disponibile la versione per ripiani rettangolari con due colonne. Piedini regolabili.
Jimmy table base with four chromed steel legs. Available two column version for rectangular tops. Adjustable feet.



(Art. 1511-1531-1541)
Piedini regolabili - Adjustable feet

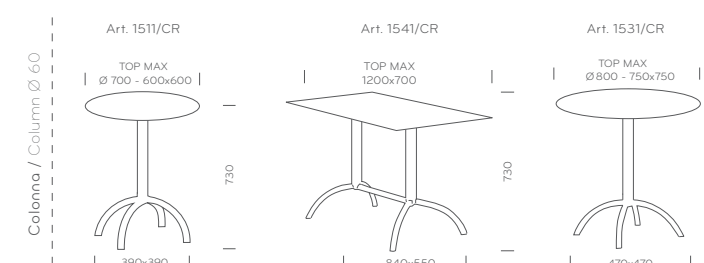

Le altezze dei basamenti indicate non sono comprensive dei ripiani.
Table bases heights do not include table tops.



1531/CR

1541/CR

Design Pedrali R&D

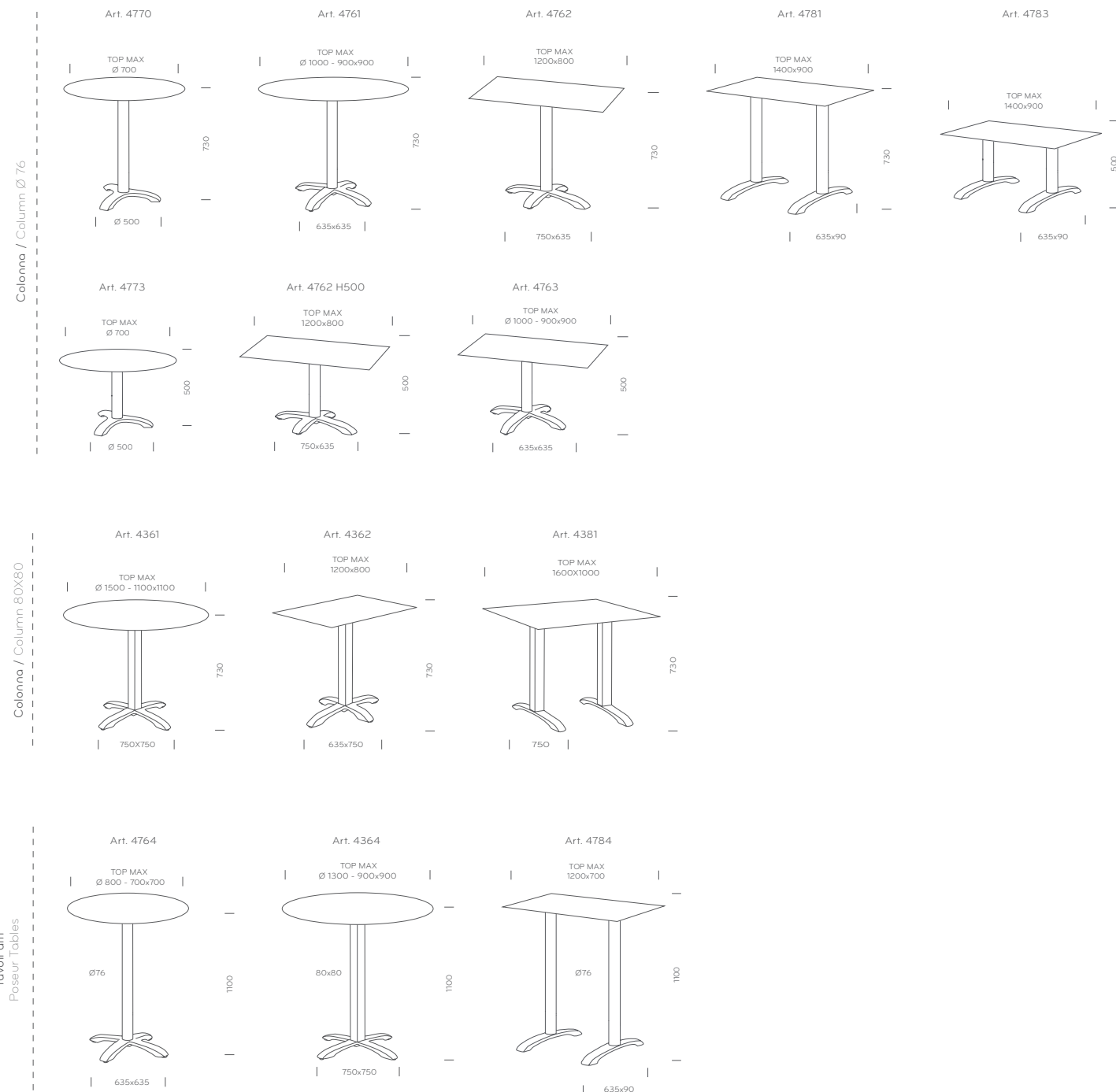

Basamento Easy, base in fusione di ghisa sabbata, colonna in acciaio, verniciato in diversi colori.
Easy table base, sand-blasted cast-iron base and steel column, powder coated in different colours.



Le altezze dei basamenti indicate non sono comprensive dei ripiani. - Table bases heights do not include table tops.

4770

Basamento Easy, base in fusione di ghisa e colonna in tubo verniciata in diversi colori sia per interno che per esterno. Piedini regolabili.
 Easy table base, cast-iron base and powder coated steel column in different finishes, both for indoor and outdoor use. Adjustable feet.



Piedini regolabili - Adjustable feet



4762

Per piano rettangolare.
 Suitable for rectangular top.

Tavolo Easy in ghisa verniciata. Piedini regolabili.
 Easy table base, cast-iron powder coated. Adjustable feet.



4761



4770



4781



4362
Per piano rettangolare.
Suitable for rectangular top.



4381/FA



4361

134 Step

Design Pedrali R&D

Basamento Step, base in fusione di ghisa sabbata e verniciata. Colonna in acciaio verniciato, cromato o in acciaio inox satinato.
Step table base, powder coated sand-blasted cast-iron base, powder coated, chromed steel or brushed stainless steel column.

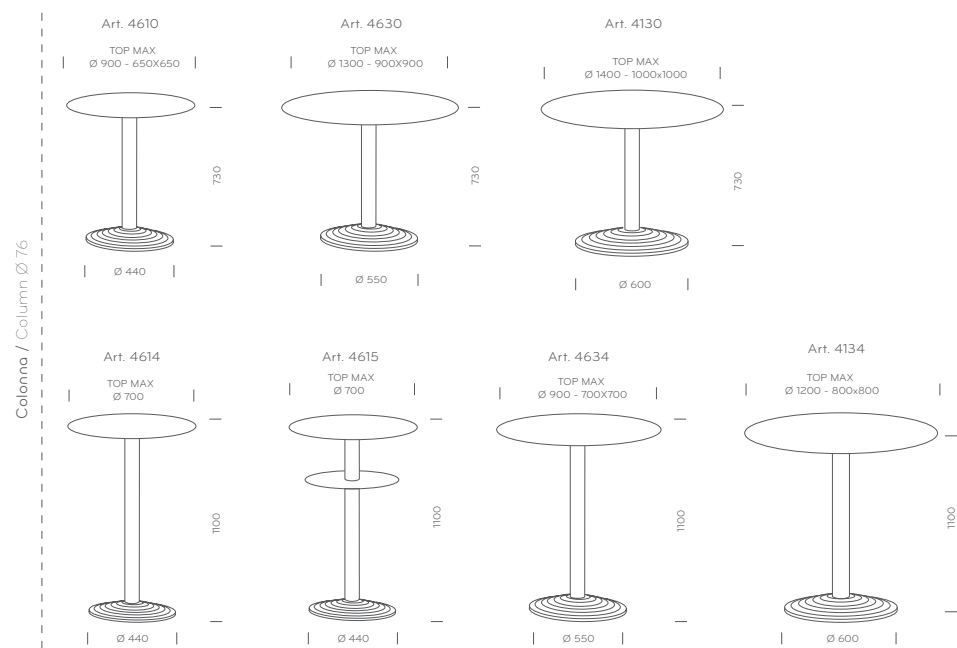

Le altezze dei basamenti indicate non sono comprensive dei ripiani.
Table bases heights do not include table tops.



4630

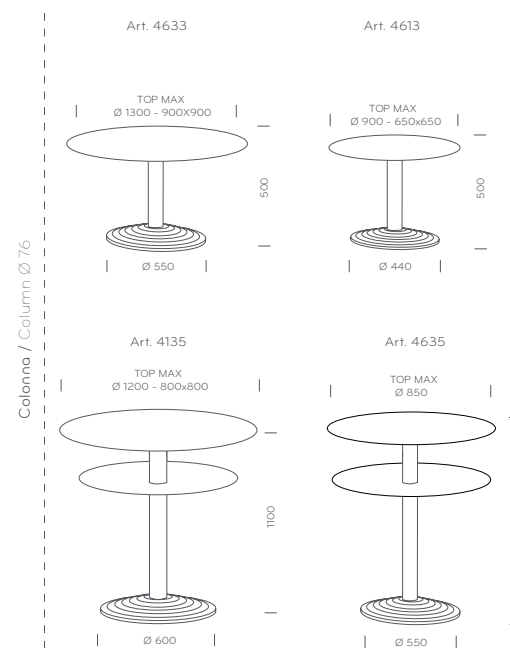

Le altezze dei basamenti indicate non sono comprensive dei ripiani.
Table bases heights do not include table tops.



4610



4610/AC

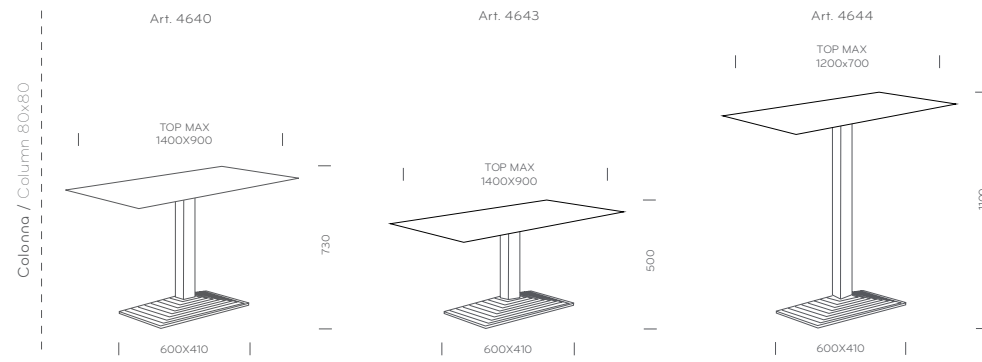

Le altezze dei basamenti indicate non sono comprensive dei ripiani.
Table bases heights do not include table tops.

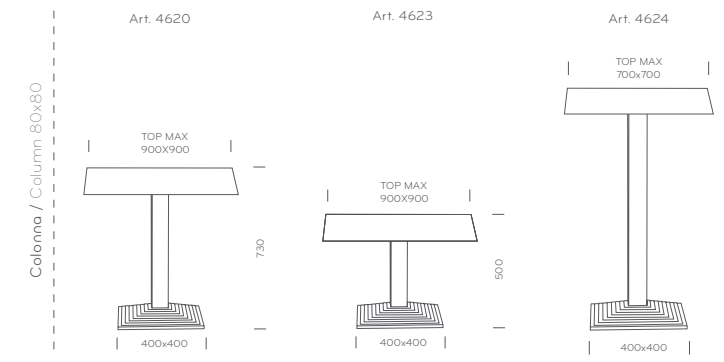

Le altezze dei basamenti indicate non sono comprensive dei ripiani.
Table bases heights do not include table tops.



4640



4620

Design Pedrali R&D

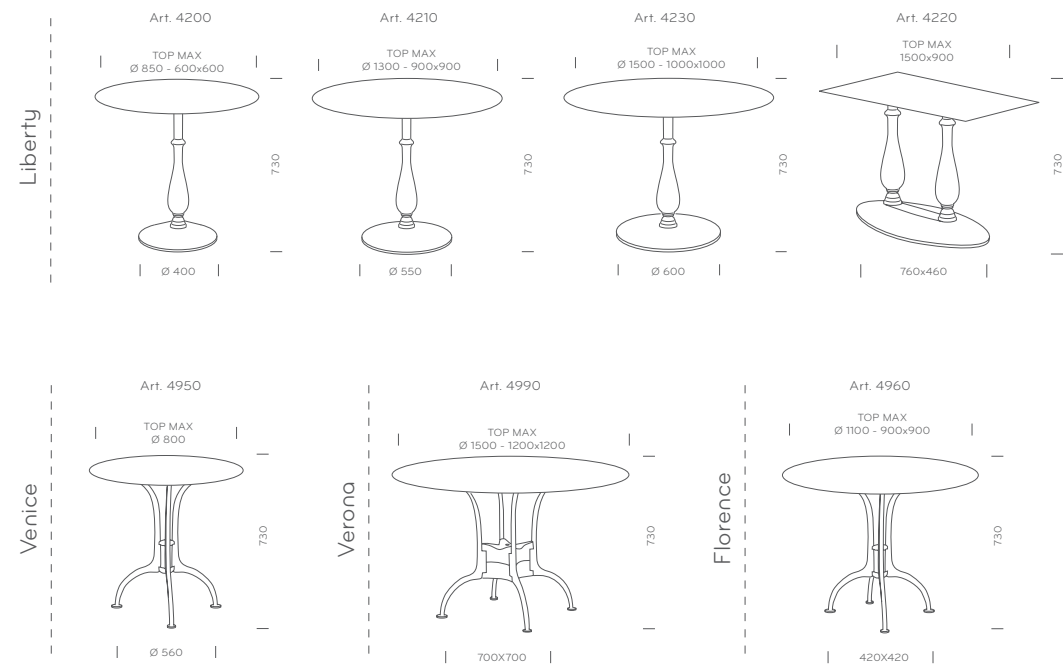

Le altezze dei basamenti indicate non sono comprensive dei ripiani. - Table bases heights do not include table tops.

Tavolo Liberty (Art. 4200_BI) in ghisa verniciata con ripiano in stratificato Compact full colour e poltroncine Gossip.
 Liberty table (Art. 4200_BI) with powder coated cast iron structure and solid laminate Compact Full Colour top. Gossip Armchairs.



Basamento Liberty in fusione di ghisa sabbata, disponibile in diversi colori e dimensioni.
Liberty table base, sand-blasted cast-iron. Available powder coated in several colours and sizes.



4200



4210



4220

142 Verona

Basamento Verona in fusione di ghisa sabbata, verniciato grigio naturale.
Verona table base, sand-blasted cast-iron, natural grey powder coated.



Piedini regolabili - Adjustable feet



4990

Basamenti Venice e Florence in fusione di ghisa sabbata, verniciati alluminio e grigio naturale. Disponibili diverse varianti di colore.
Venice and Florence table base, sand-blasted cast-iron, aluminium or natural grey powder coated. Available in several colours.



Piedini regolabili - Adjustable feet



4960

Florence _ Venice 143



4950

144 Arki-Table

Design Pedrali R&D

Lineare e rigoroso nel progetto, versatile nell'adattamento alle diverse situazioni. Il tavolo Arki-Table ha un ripiano in stratificato ultrasottile 6 mm o 8 mm, le gambe a cavalletto in acciaio ed un supporto in estruso di alluminio. Disponibile nelle versioni bianco e nero full colour per indoor o nella versione bianco full colour con struttura verniciata per outdoor.

Clean and rigorous in the design project but versatile in its different applications. Arki-Table, ultra-thin solid laminate top 6 mm or 8 mm thickness, frame made of extruded aluminium, trestle steel legs. Available in white or black full colour versions for indoor use, white full colour version with powder coated frame for outdoor use.

145



Adatto sia per le sale meeting che per le sale da pranzo, Arki-Table è disponibile anche con ripiano rettangolare dotato di canalina per i cavi.
 Arki-Table is suitable either for meeting areas or for restaurant halls. Rectangular top available with cable management on request.

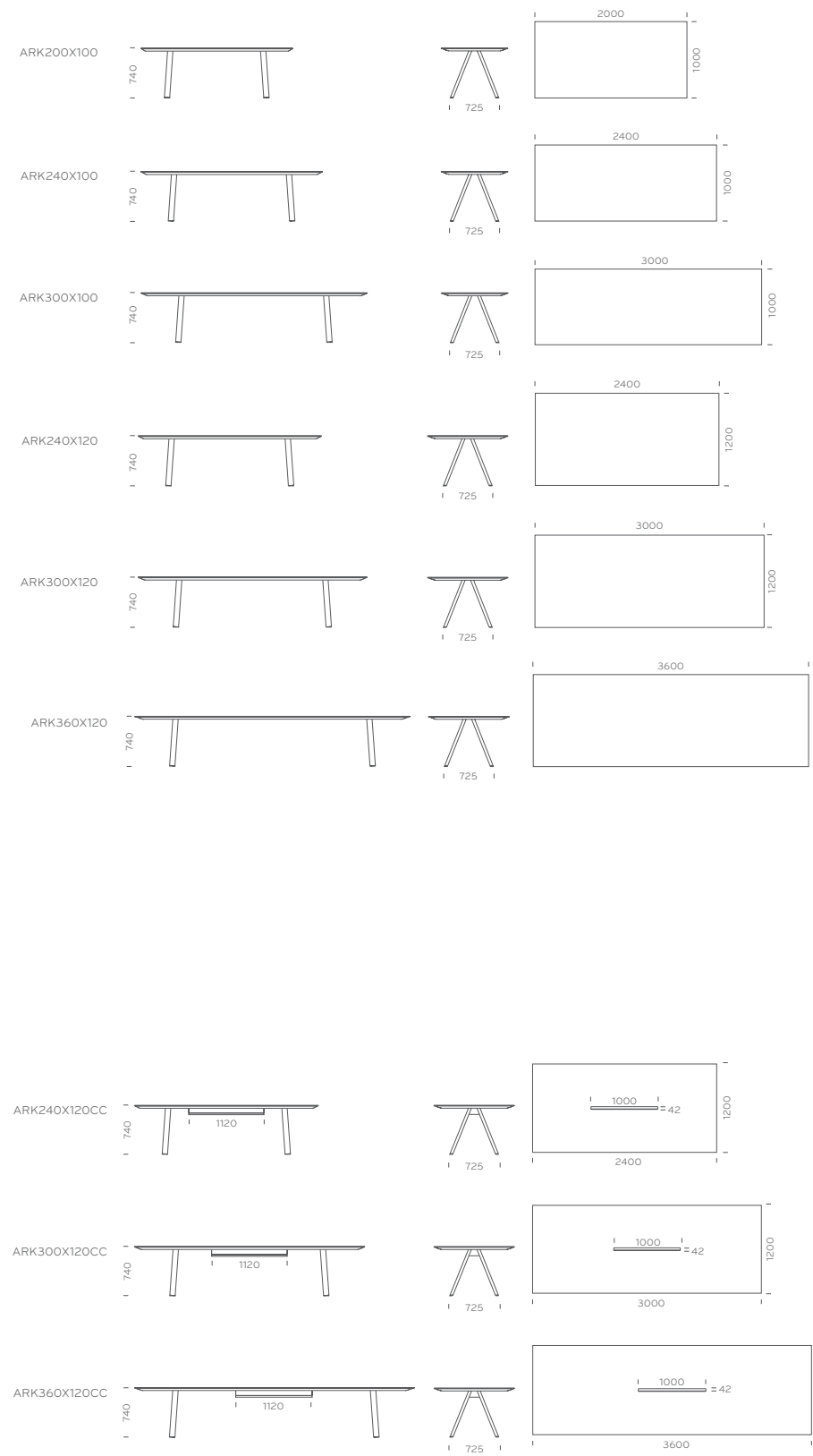

148 Arki-Table

Arki-Table nella versione con ripiano quadrato oppure tondo ha ripiano ultrasottile a sbalzo in stratificato spessore 12 mm e le caratteristiche gambe a cavalletto.
 Arki-Table, round or square version with extremely thin solid laminate top 12 mm thickness and the peculiar structure with trestle legs.

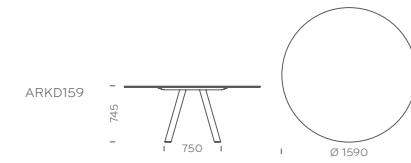
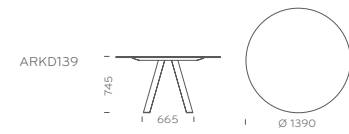

ARK139X139



ARKD159

150 Arki-Table Wood

Arki-Table con gambe in massello di rovere, finitura rovere sbiancato. Supporto in estruso di alluminio verniciato in tinta col ripiano in stratificato bianco o nero.
 Arki-Table solid oak legs version, bleached oak finish. Frame made of extruded aluminium powder coated in the same white or black colour of the solid laminate top.

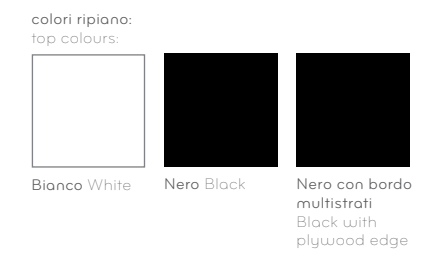
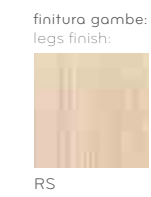
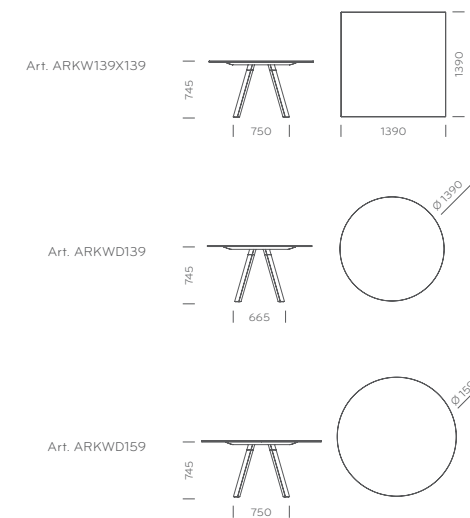
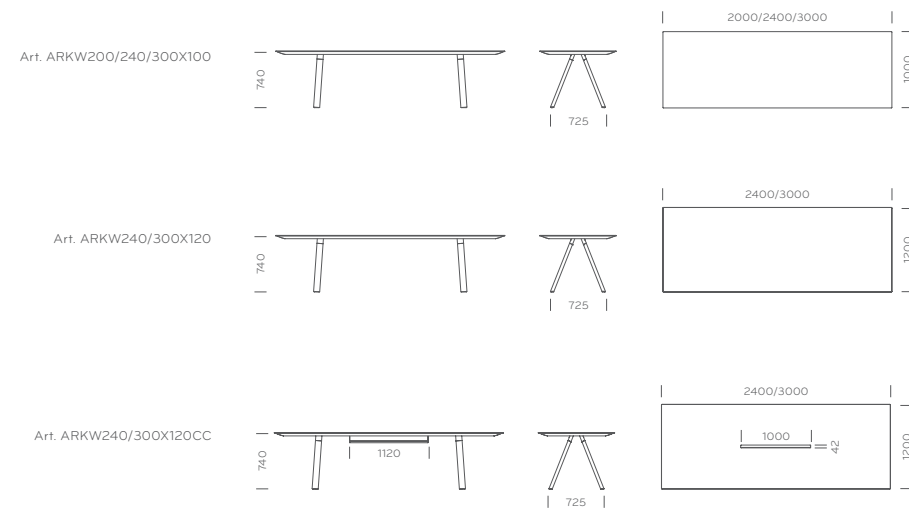

Ripiano nero con bordo multistrati
Black top with plywood edge



152 Arki-Table

Arki-Table nella versione alta è una soluzione versatile adatta ai diversi ambienti dell'ufficio. Postazione di lavoro, tavolo da lettura o consultazione per le aree condivise degli spazi pubblici.
Arki-Table high version is a versatile solution suitable for different office environments. Workstation, table for reading or meeting for shared areas of public spaces.

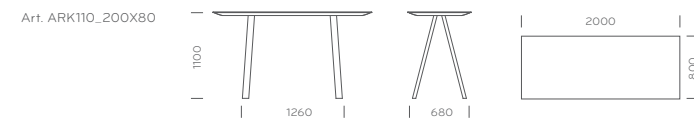

colore ripiano:
top colour:



Bianco White



Nero Black



finiture struttura:
frame finishes:



BI



NERO



154 Fabbrico

Design Pedrali R&D

Fabbrico è una collezione di tavoli fissi in diverse dimensioni caratterizzati da un'estetica pulita e linee rigorose. La scelta di utilizzare l'acciaio sia per il ripiano che per le gambe lo rendono riciclabile al 100%.
Fabbrico is a fixed tables collection of different sizes featured by a clean design and rigorous shapes.
The choice of the steel for both the top and the legs makes it 100% recyclable.

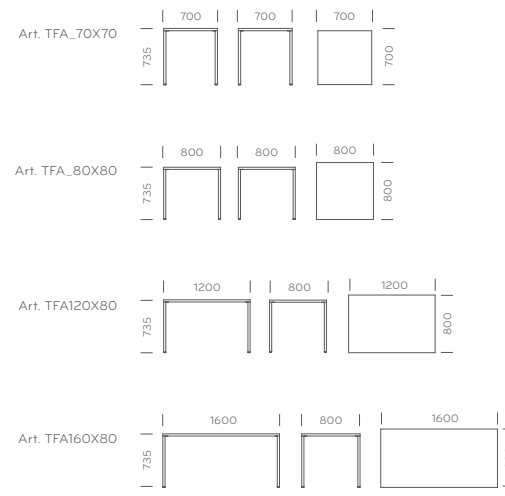

finiture / finishes:



BIE



RUE



GNE



TR



TFA_80X80_BIE



156 Fabbrico

Fabbrico è disponibile in diverse finiture con verniciatura a polvere per outdoor ed una trasparente dall'effetto industrial per indoor.
Fabbrico is available in different finishes: powder coated for outdoor and transparent "industrial" effect for indoor use.

157



TFA160X80_TR



Il tavolo allungabile More inaugura una nuova dimensione nella versatilità arredando lo spazio domestico con stile e qualità. Disponibile in 3 diverse misure, ha il telaio in acciaio sagomato con le guide scorrevoli in alluminio ed il ripiano in nobilitato.
 More table is the expression a new dimension of versatility by decorating the living space with style and quality. More table is available in three different dimensions. Shaped structural steel legs, aluminium sliding rails, melamine top.

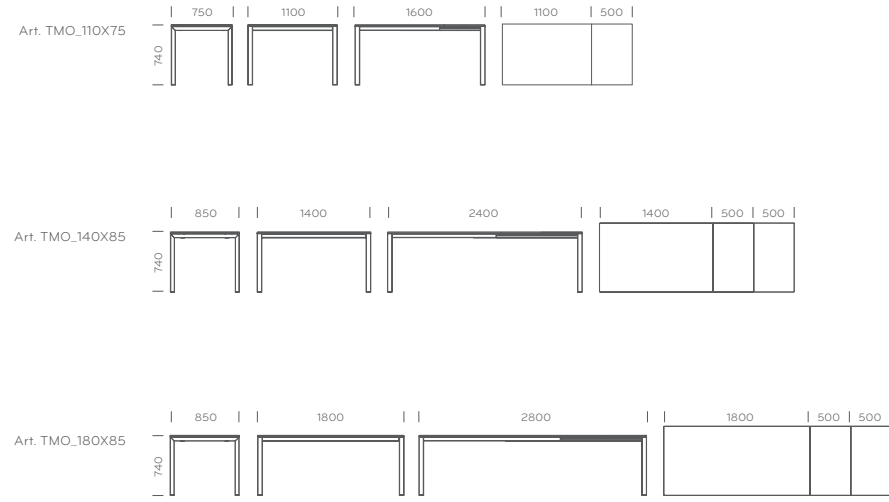

finitura struttura:
frame finish:
BI

colore ripiano:
top colour:
Bianco - White



TMO_140X85_BI





Design Odo Fioravanti

Il tavolo Serif declina lo stile architettonico dello sgabello mantenendo ottime doti di funzionalità. Realizzato in polietilene con la tecnica dello stampaggio rotazionale, è proposto in bianco e in grigio chiaro in abbinamento a ripiano in stratificato.

Serif table declines the architectural style of the barstool preserving optimal features of functionality. Made of rotomoulded polyethylene with solid laminate top, it is available in white and light grey finishes.

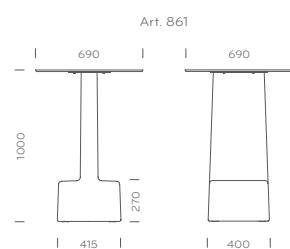

finiture basamento:
table base finishes:



BI

GC

colore ripiano:
top colour:



CFC_BI

COL_263



861





Snow table vuole comunicare le stesse sensazioni di dinamismo e velocità già proprie della Snow chair. Tavolo con ripiano in polipropilene stampato in gas air moulding e gambe in estruso di alluminio verniciate. Ideale per indoor e outdoor è disponibile nei colori bianco, sabbia e beige.

Snow table project took life from the idea to match a table to Snow chair, maintaining the same dynamism and speed in three-dimensional shape. Table with extruded aluminium legs, powder coated finish, and gas air moulding polypropylene top. Ideal for indoor and outdoor, Snow table is available in white, sand or beige colours.

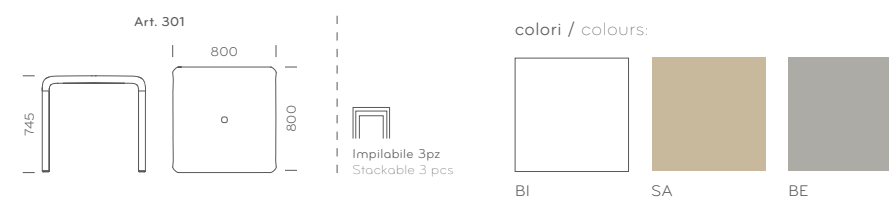

166 Jump

Design Pedrali R&D

Jump

Impilabile
Stackable
5 pz

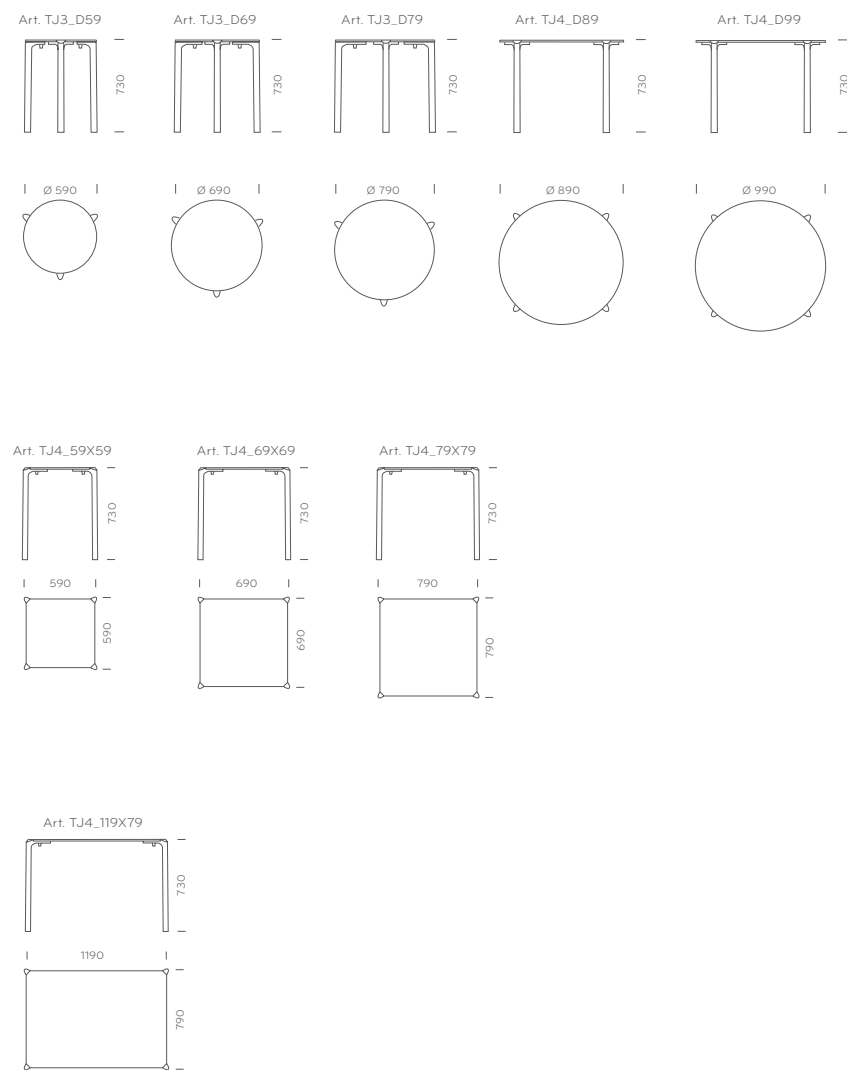

Jump tavolo impilabile, per esterni o tre o quattro gambe. Le gambe realizzate in estruso di alluminio disponibili nelle versioni lucidato, verniciato bianco o nero sono fissate al ripiano grazie a pressofusioni in alluminio nello stesso colore delle gambe. Ripiani in stratificato in diverse dimensioni e colori.

Jump stackable table, suitable for outdoor use, 3 or 4 legs version. Extruded aluminium legs (available in polished, white or black powder coated finish) are fixed to the top by means of aluminium die-castings. Solid laminate tops available in different sizes and colours.



168 Jump

Tavoli Jump versione con tre e quattro gambe in alluminio verniciato o lucidato. Impilabili.

Jump tables, 3 or 4 polished aluminium legs version. Stackable.



TJ3_BI + D_79CFC



TJ3_NERO + D_69COM





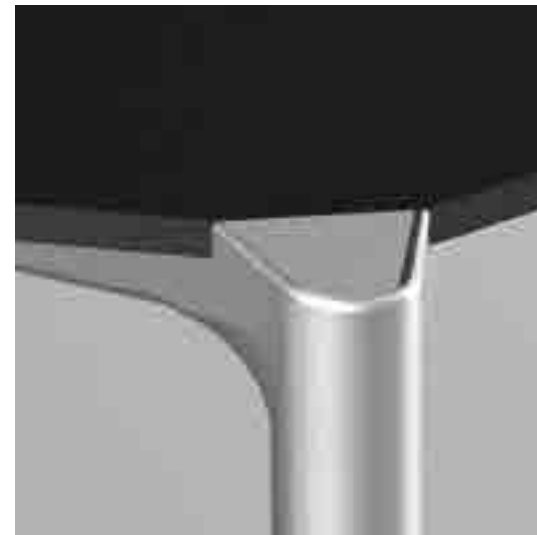

TJ3_NERO + D_59COM

170 Jump







Jump, tavolo impilabile nella versione con quattro gambe in alluminio lucidato e con ripiano stratificato nero. Piedini in polietilene.
 Jump, stackable table 4 legs version, polished aluminium legs and solid laminate top in black colour, polyethylene feet.



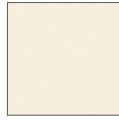

finiture struttura:
frame finishes:

				
	BIE	NERO		LU

colore ripiano:
laminata colour:

					
	CFC_BI	851	Bianco-White	263	2810

		
	526	Nero - Black



TJ4_LU + _119X79CFC



TJ3_LU + D_69CFC

TJ4_LU + _69x69COM

172 Togo

Design Pedrali R&D

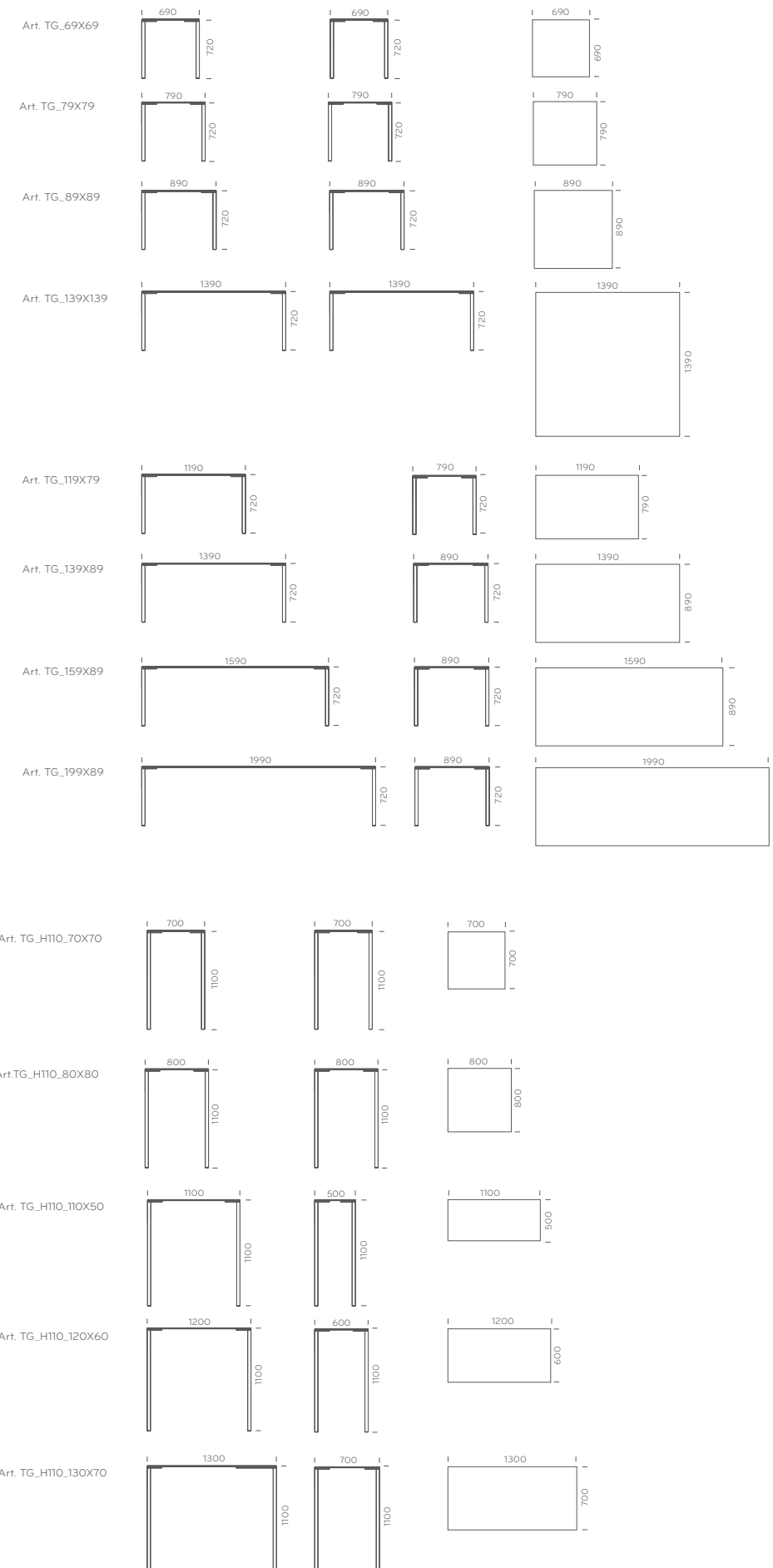

Tavolo Togo, versione con gambe e piastre di fissaggio in alluminio satinato e ripiano in stratificato nero.
Togo table, legs and fixing in brushed aluminium version with black solid laminate top.





176 Togo

Tavolo Togo, versione monocromatica nero con gambe 40X40 mm in estruso di alluminio fissate al ripiano mediante piastre in pressofusione di alluminio.
Togo table, black monochromatic version with extruded aluminium legs section 40X40 mm, connected to the top by means of aluminium die-casted plates.



TG_NERO + 119X79COM

Togo tavolo per esterni, con gambe 40X40 mm in estruso di alluminio fissate al ripiano mediante piastre in pressofusione di alluminio. Gambe disponibili satinato o verniciato bianco o nero. Ripiani in stratificato e in laminato in diversi colori e in varie dimensioni.

Togo table, suitable for outdoor use as well, extruded aluminium legs 40X40 mm fixed to the top by die-casted aluminium plates. Legs available in brushed aluminium or white or black powder coated finish. Solid laminate tops, laminate tops available in different colours and different sizes.

finiture struttura:
frame finishes:

	BIE	NERO		AS

colore ripiano:
laminated colour:

	CFC_BI	Bianco-White	851	263	2810

	526	Nero - Black



TG_BI + _89X89CFC



Togo è disponibile anche altezza 1100 mm. Versione con gambe verniciate bianco e ripiano in laminato bianco. Spessore 20 mm.
Togo is also available in height 1100 mm. White powder coated legs version and white laminate top. 20 mm Thick.



180 Kuadro_Logico

Design Pedrali R&D

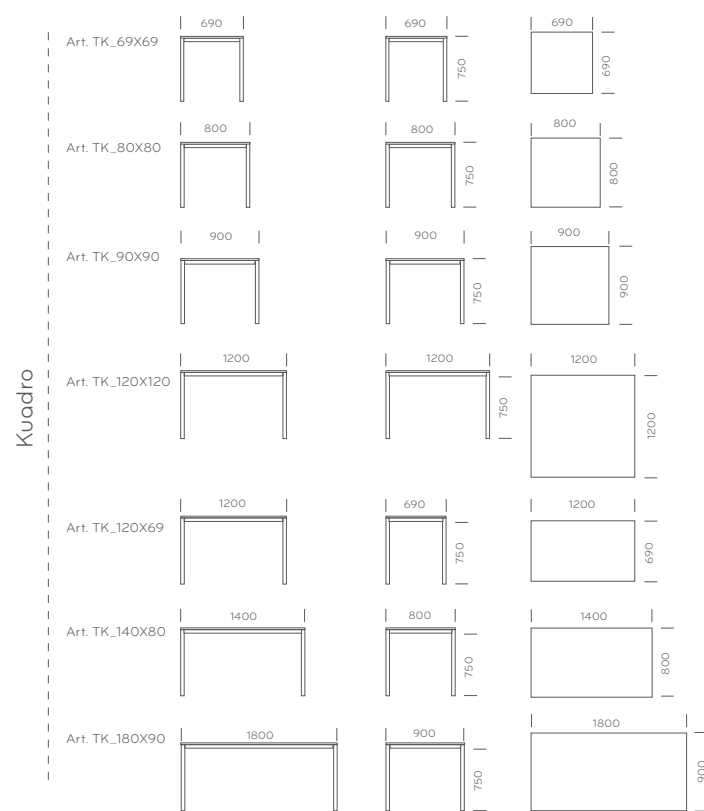

Logico

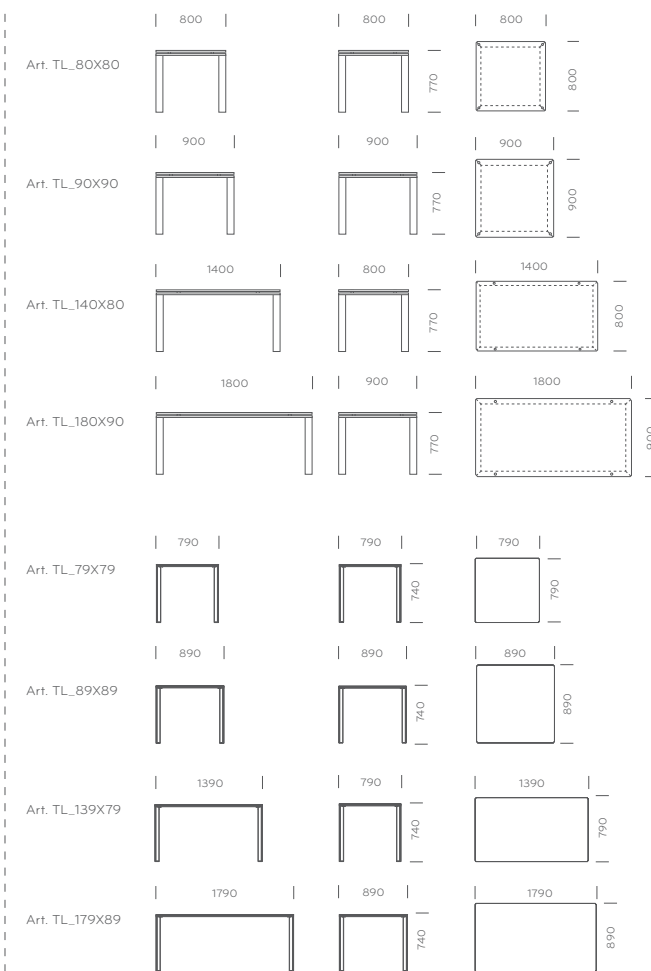

Tavolo Kuadro (Art. TK_120X69) con struttura in acciaio cromato e ripiano in vetro acidato. Sedie Day Dream.
 Kuadro table (Art. TK_120X69) with chromed steel frame and glass frosted tempered top. Day Dream chairs.

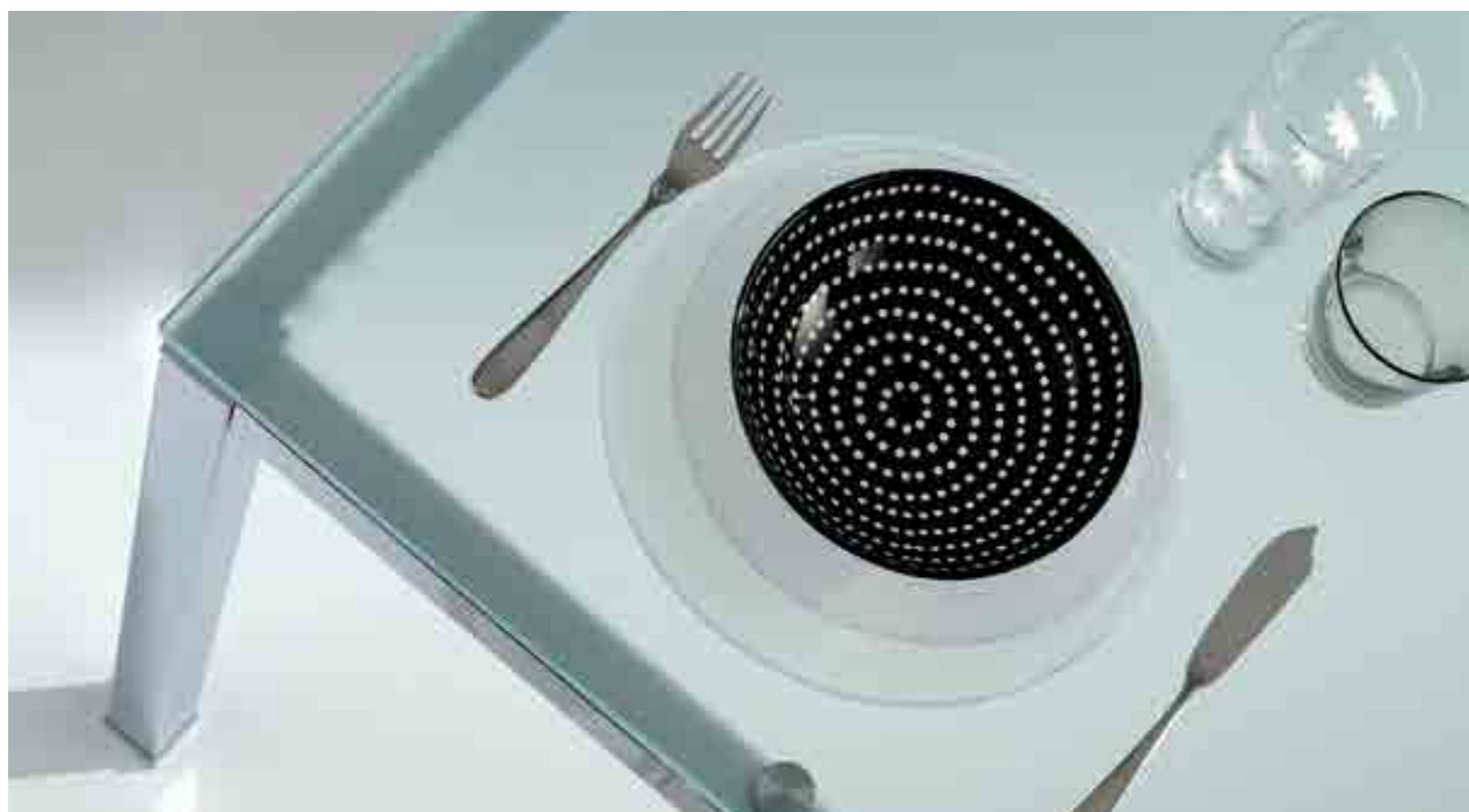

Tavolo Kuadro nella versione con struttura in acciaio cromato, satinato o verniciato per interno in diversi colori e ripiano in laminato o stratificato.
 Kuadro table with chromed, satinized or powder coated steel frame for indoor in different colours and laminate or solid laminate top.

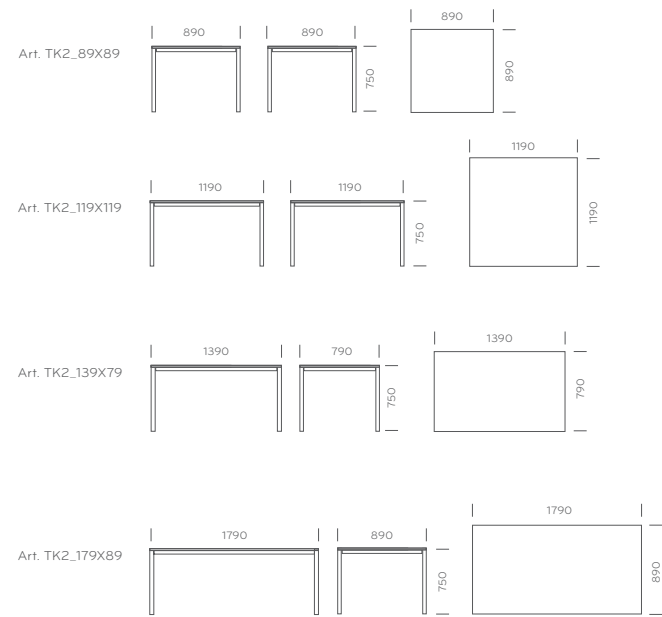
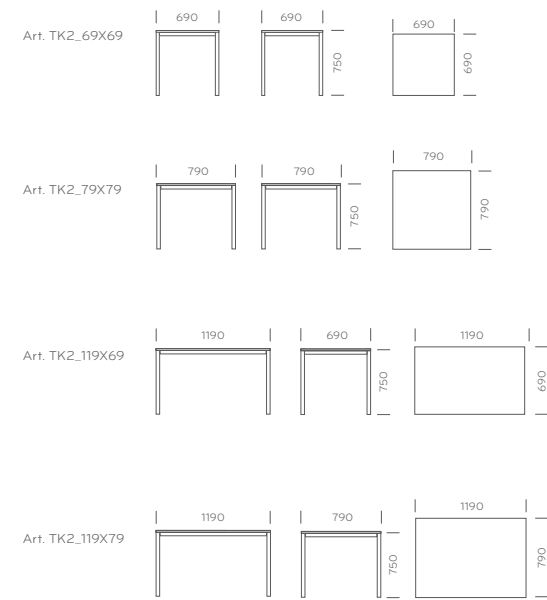

colore ripiano:
laminato colour:

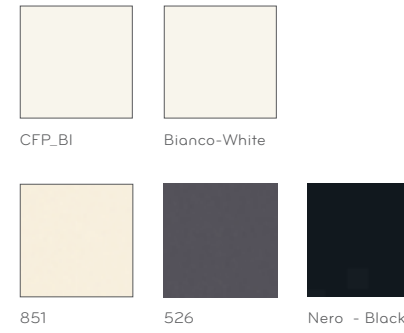

finiture struttura:
frame finishes:

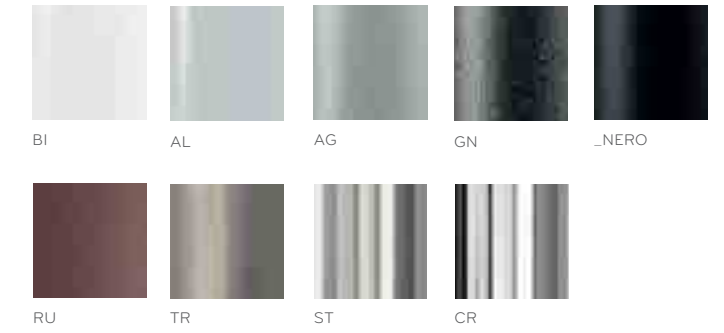

TK2_119X119



TK2_119X119

184 Kuadro Desk

Kuadro Desk è la versione operativa del tavolo Kuadro. Scrivania a due o quattro postazioni, ha ripiano in laminato con canalina passacavi e telaio in acciaio verniciato. Accessoriabile con pannello divisorio rivestito in tessuto per la definizione e separazione dello spazio. Kuadro Desk is the operative version of Kuadro table. Two or four seats work station, laminated top with cable management and powder coated steel frame. On request dividing panel covered in fabric for the separation of the space.

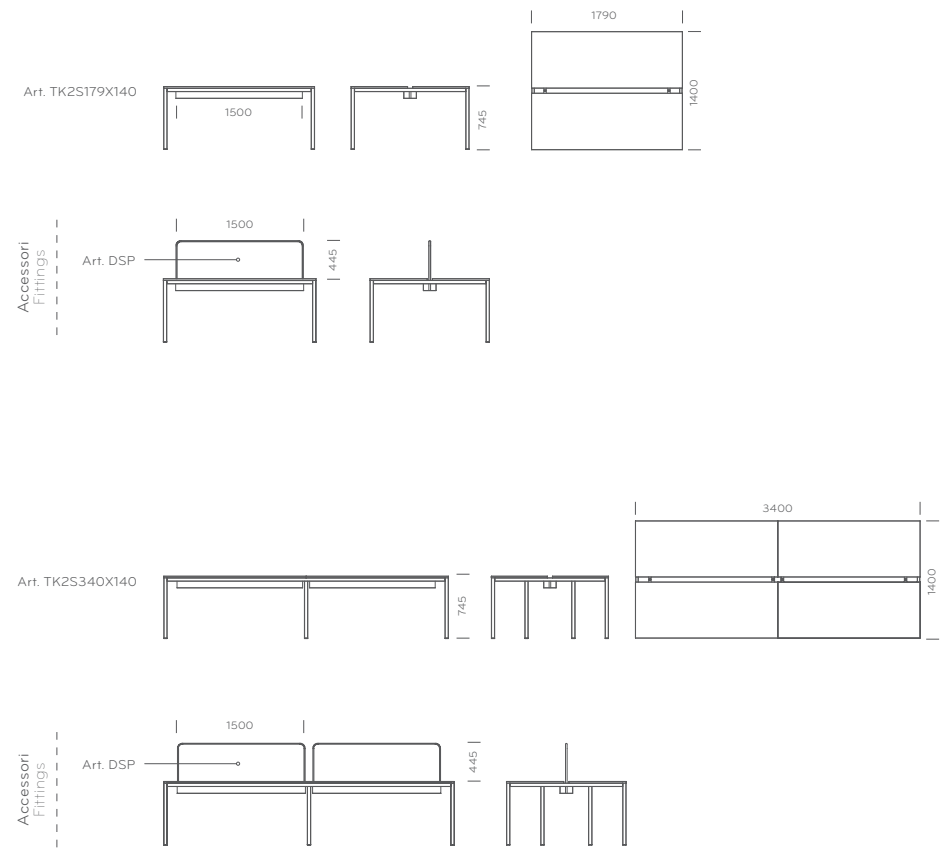

finiture struttura:
frame finishes:



BI 527

colori laminati:
laminated colours:



406_0020 527



Tavolo Logico con struttura in acciaio inox satinato. Le gambe a sezione rettangolare 60X20 mm sono orientate con angolo a 45°. Ripiano in vetro temperato acidato, spessore 12 mm.
 Logico Table with brushed stainless steel frame. 60X20 mm steel tube legs are oriented with a 45° angle. Frosted tempered glass top thickness 12 mm.

colore vetro:
glass colour:

finiture struttura:
frame finishes:



TL_140X80

Tavolo Logico (Art. TL_140X80) in acciaio inox satinato e top in vetro acidato. Sedie Mya.
 Logico table (Art. TL_140X80) with brushed stainless steel frame and frosted glass top. Mya chairs.



Tavolo Logico con struttura in acciaio verniciato bianco e ripiano in stratificato bianco. Disponibile sia nella versione con ripiano quadrato che rettangolare.
Logico table, white powder coated frame and white solid compact top. Square or rectangular top version available.

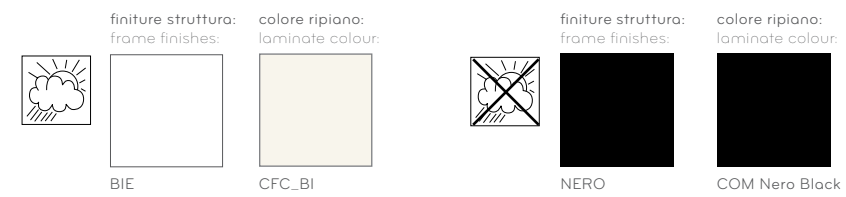

190 Magic_Space

Design Pedrali R&D

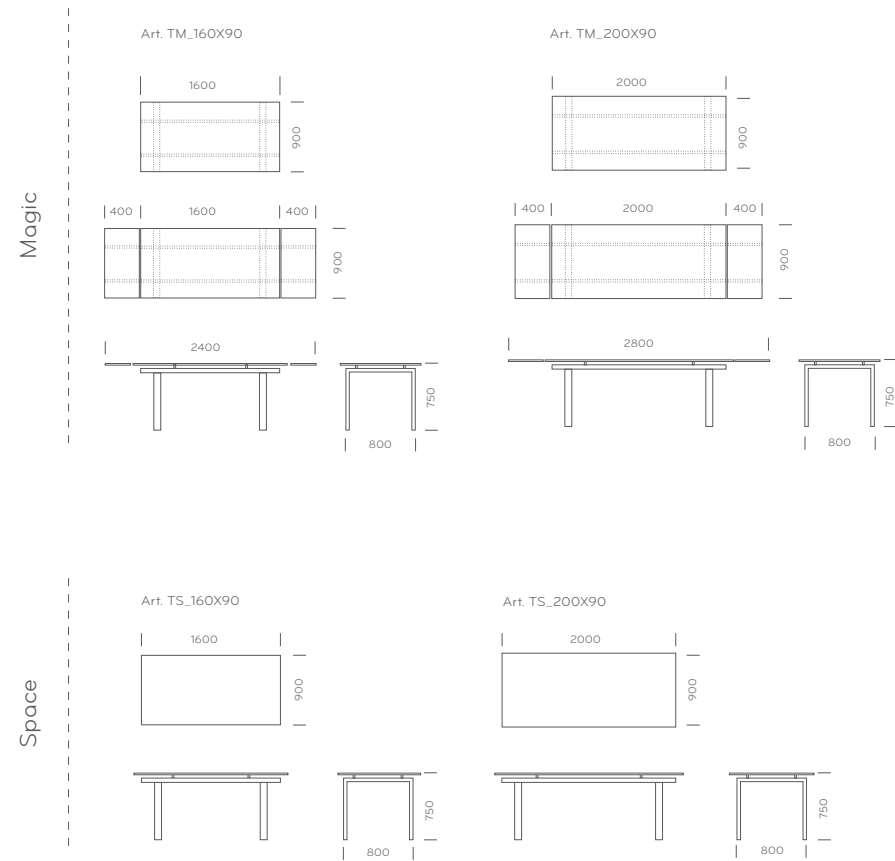

Tavolo Magic (Art. TM_200X90) allungabile, struttura in acciaio inox satinato e ripiano in vetro temperato. Sedie Mood.
Magic extendable table (Art. TM_200X90), with brushed stainless steel frame and tempered glass top. Mood chairs.



Tavolo Magic (Art. TM_200X90) allungabile, struttura in acciaio inox satinato con gambe a sezione rettangolare 80x40 mm. Ripiano in vetro temperato spessore 12 mm, trasparente o acidato. Sedie Zen. Magic extendable table (Art. TM_200X90), with brushed stainless steel frame and 80x40 mm section legs. Tempered glass top thickness 12 mm, transparent or frosted. Zen chairs.





TM_200X90

Struttura in acciaio inox satinato con gamba a sezione rettangolare 80x40 mm.
Ripiano in vetro temperato spessore 12 mm, acidato.
Brushed stainless steel frame with 80x40 mm section legs.
Frosted tempered glass top thickness 12 mm.

colore vetro:
glass colour:



TRA



SAT

finiture struttura:
frame finishes:



AC

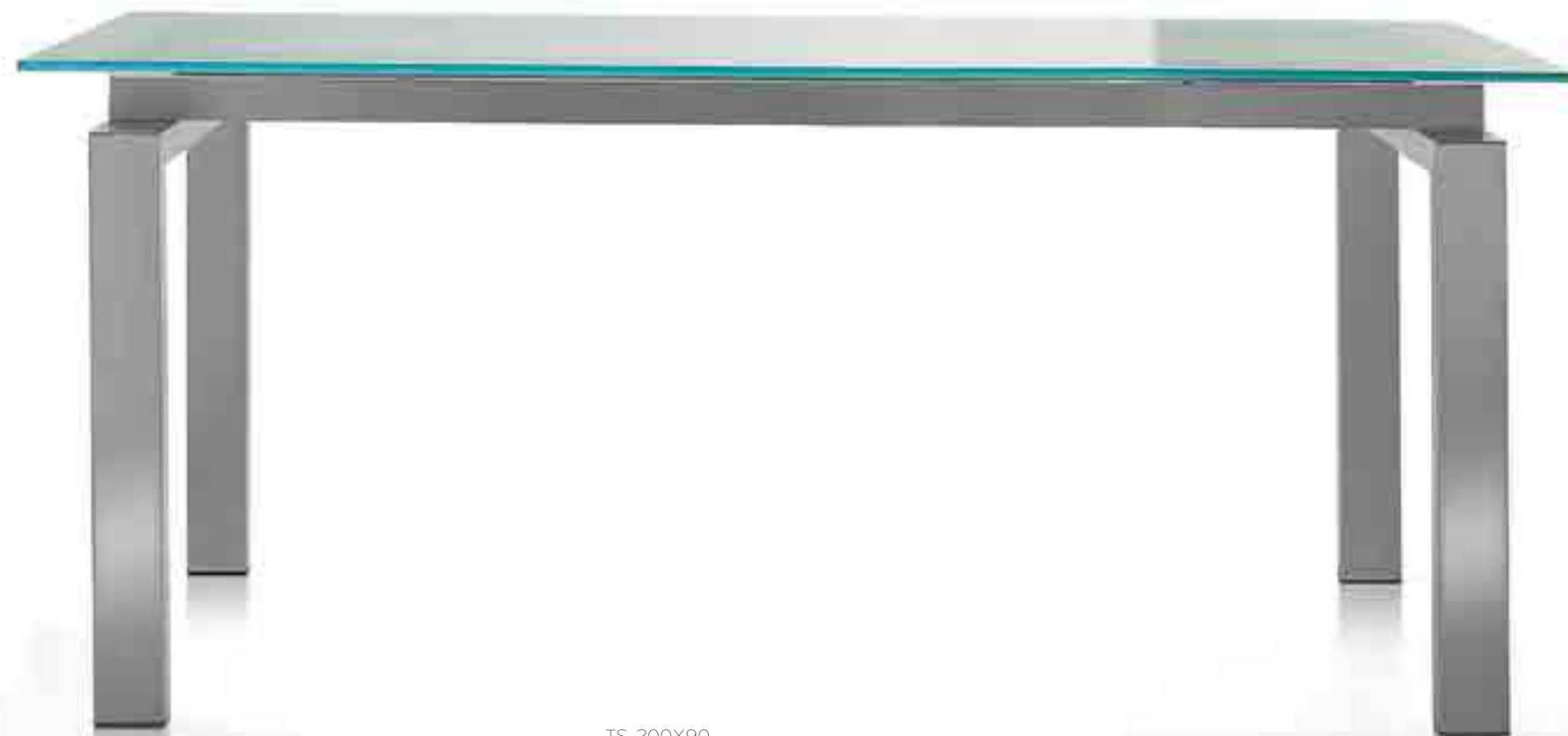

TS_200X90



198 Space

Struttura in acciaio inox satinato con gamba a sezione rettangolare 80x40 mm. Ripiano in laminato con bordo ABS spessore 30 mm, color wengé, disponibile anche bianco o rovere sbiancato.
Brushed stainless steel structure with 80x40 mm section legs. Wenge laminate top, thickness 30 mm, abs edge. Available also white or bleached oak.

colore ripiano:
laminato colour:



312



386



406_0020



Design Claudio Dondoli and Marco Poggi

Tavolo Matrix versione fissa (Art. TMF_86X86), con struttura in estruso d'alluminio verniciato e ripiano in vetro temperato laccato nero. Sedie Day Dream.
 Matrix fixed version table (Art. TMF_86X86), with black laquered aluminium extruded legs and tempered black laquered glass top. Day Dream chairs.

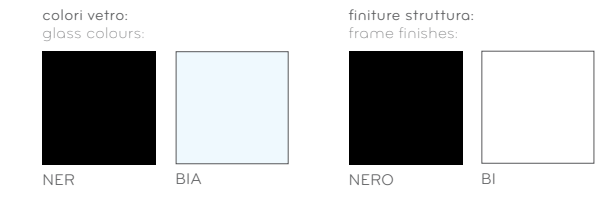
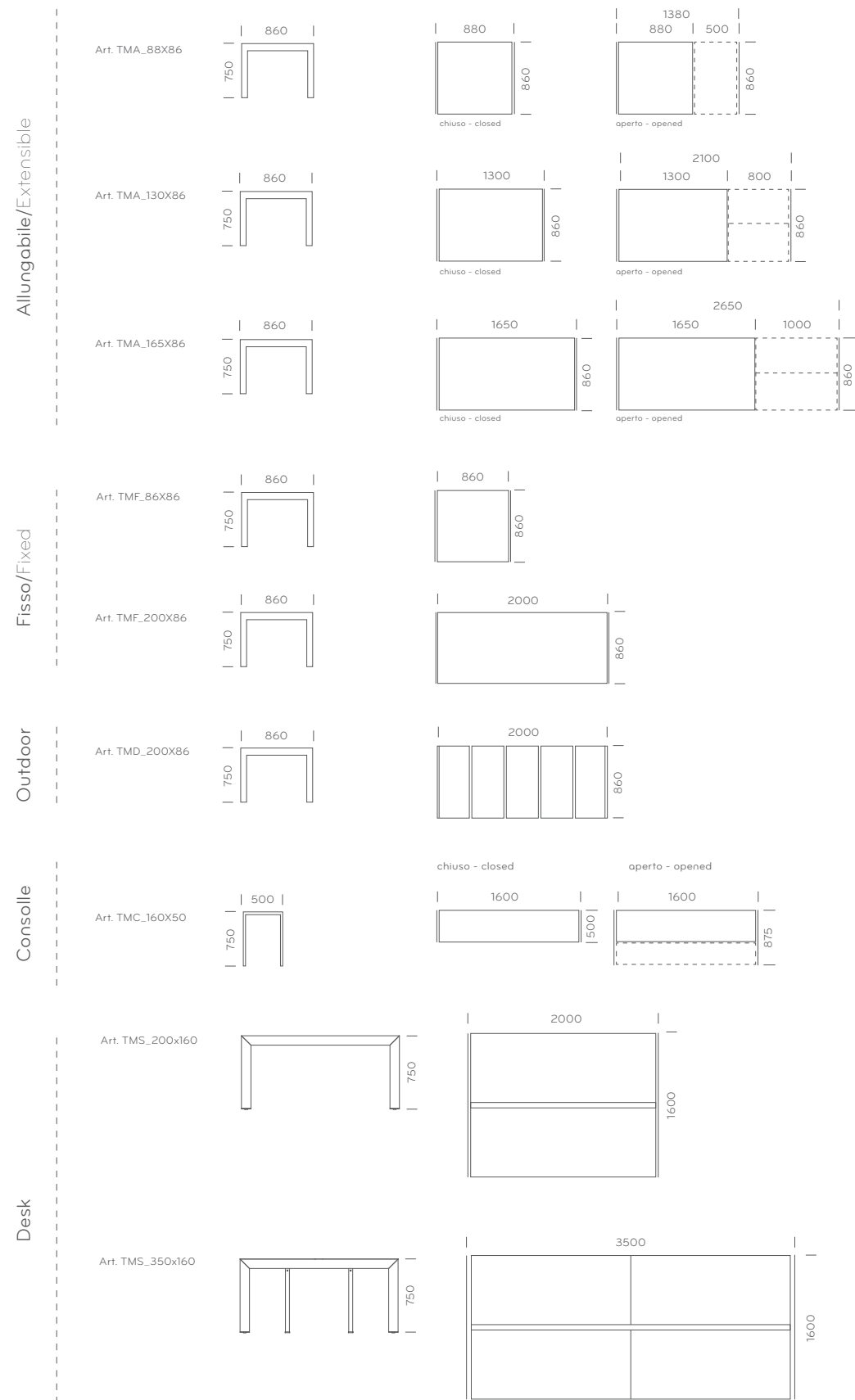

202 Matrix

Struttura in estruso d'alluminio, laccato nero. Ripiano in vetro temperato 1650X860 mm, laccato nero. Sistema di allunghe telescopiche in estruso d'alluminio che permettono l'estensione di un metro di lunghezza. Le gambe sono munite di ruote che ne facilitano l'apertura.
Extruded aluminium frame, black laquered. Tempered glass top, black laquered 1650X860 mm. Telescopic sliding rail system allows 1 meter of extension. Wheeling system that allows the legs slide.

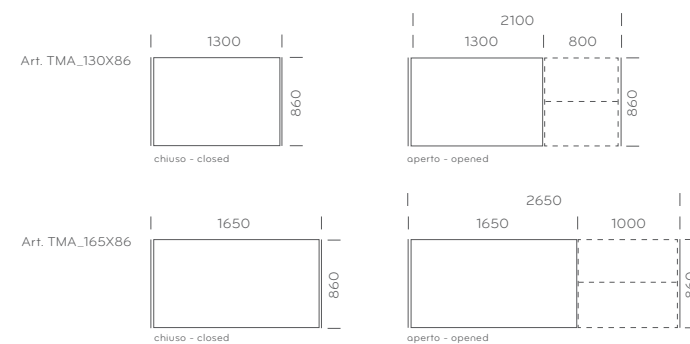

colori vetro:
glass colours:



BIA NER

finiture struttura:
frame finishes:



BI AA NERO



Tavolo Matrix allungabile (Art. TMA_130X86), con struttura in estruso di alluminio verniciato e ripiano in vetro temperato laccato. Le guide telescopiche permettono una facile apertura. Particolare il sistema di ruote che permette di far scivolare le gambe che rimangono sempre all'estremità del tavolo. Sedie Mya.

Matrix extendable table (Art. TMA_130X86), with extruded aluminium legs and tempered laquered glass top. Telescopic sliding rail system allows an easy opening. The wheeling system makes the legs slide towards the external sides of the table. Mya chairs.

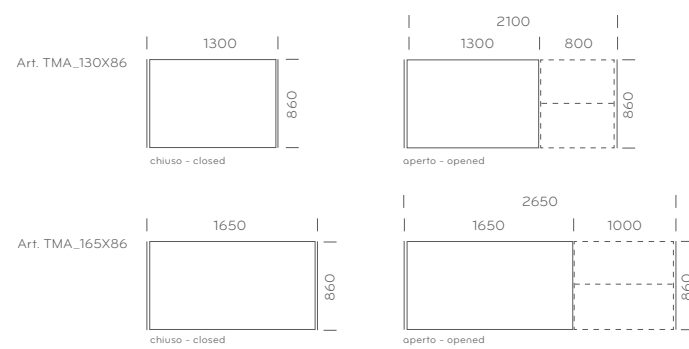



Dettaglio della gamba in alluminio anodizzato.
Detail of the anodized aluminium leg.



TMA_165X86

Tavolo Matrix allungabile (Art. TMA_165X86) con struttura in alluminio anodizzato e ripiano in laminato bianco. Sedie Mya.
Matrix extendable table (Art. TMA_165X86) with anodized aluminium frame and white laminate top. Mya chairs.

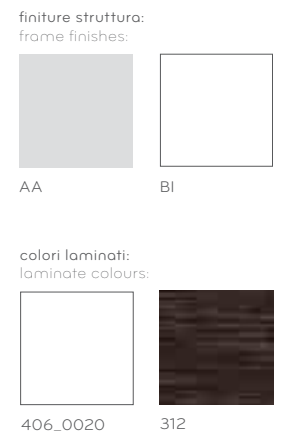
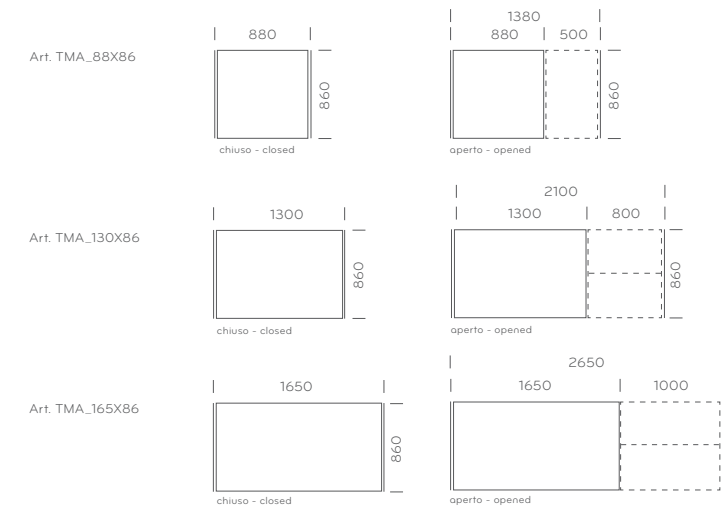

208 Matrix Consolle



Matrix Consolle (Art. TMC_160X50) ha struttura in estruso di alluminio laccato nero e ripiano in vetro temperato, laccato nero. La prolunga con apertura a libro in mdf laccato nero, permette un'apertura fino a 1600x875 mm. Sedie Kuadra. Matrix Consolle (Art. TMC_160X50) with laquered extruded aluminium frame, black laquered and tempered black laquered glass top. The black laquered folding mdf extension allows to open to 1600x875 mm. Kuadra chairs.

209

Art. TMC_160X50



colori vetro:
glass colours:



NER

finiture struttura:
frame finishes:



NERO



210 Matrix Desk

Matrix Desk scrivania a due o quattro postazioni. Ripiani in laminato con apertura per passaggio dei cavi, struttura in estruso d'alluminio anodizzato. Accessoriabile con canalina passacavi e pannello divisorio rivestito in tessuto per la definizione e la separazione dello spazio.

Matrix Desk, two or four seats work station. Laminate tops with wiring gap between one top and the other, extruded aluminium frame, anodized finish. On request, cable management and dividing panel covered in fabric for the separation of the space.

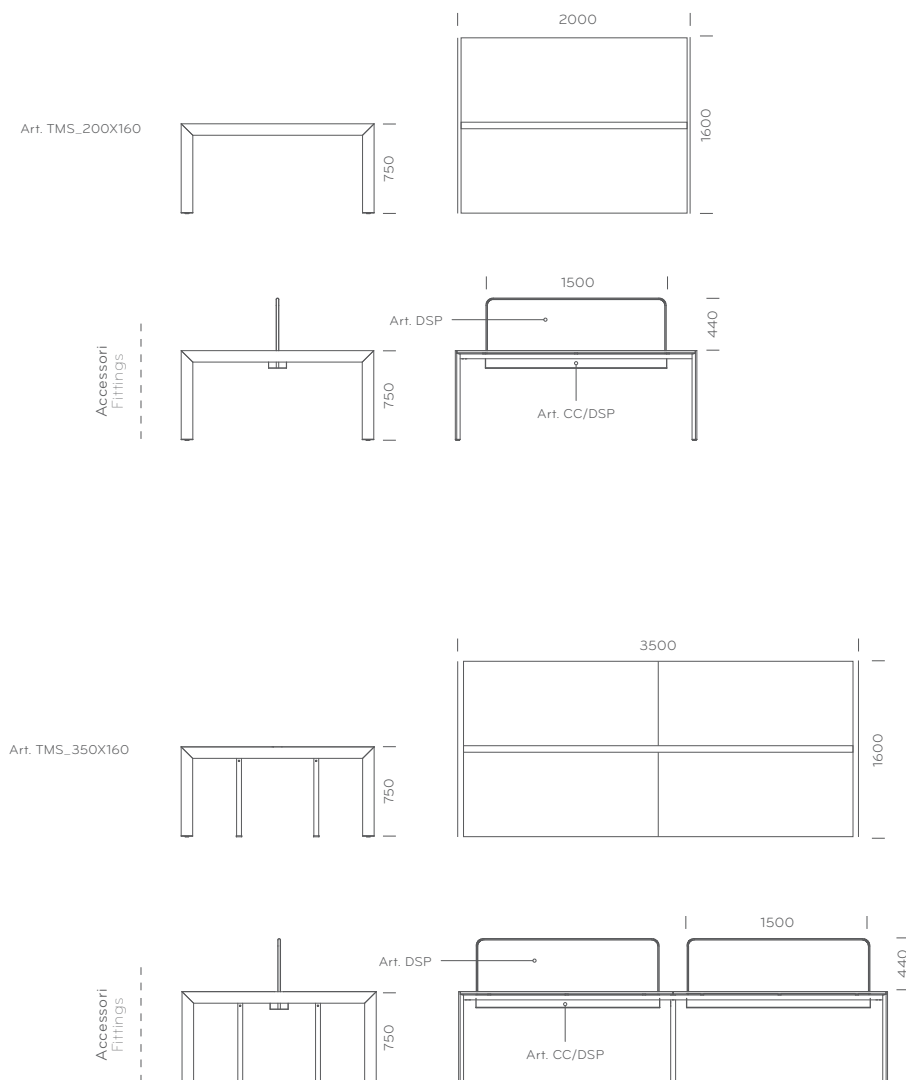

finiture struttura:
frame finishes:



AA

colori laminati:
laminates colours:



406_0020



527



312

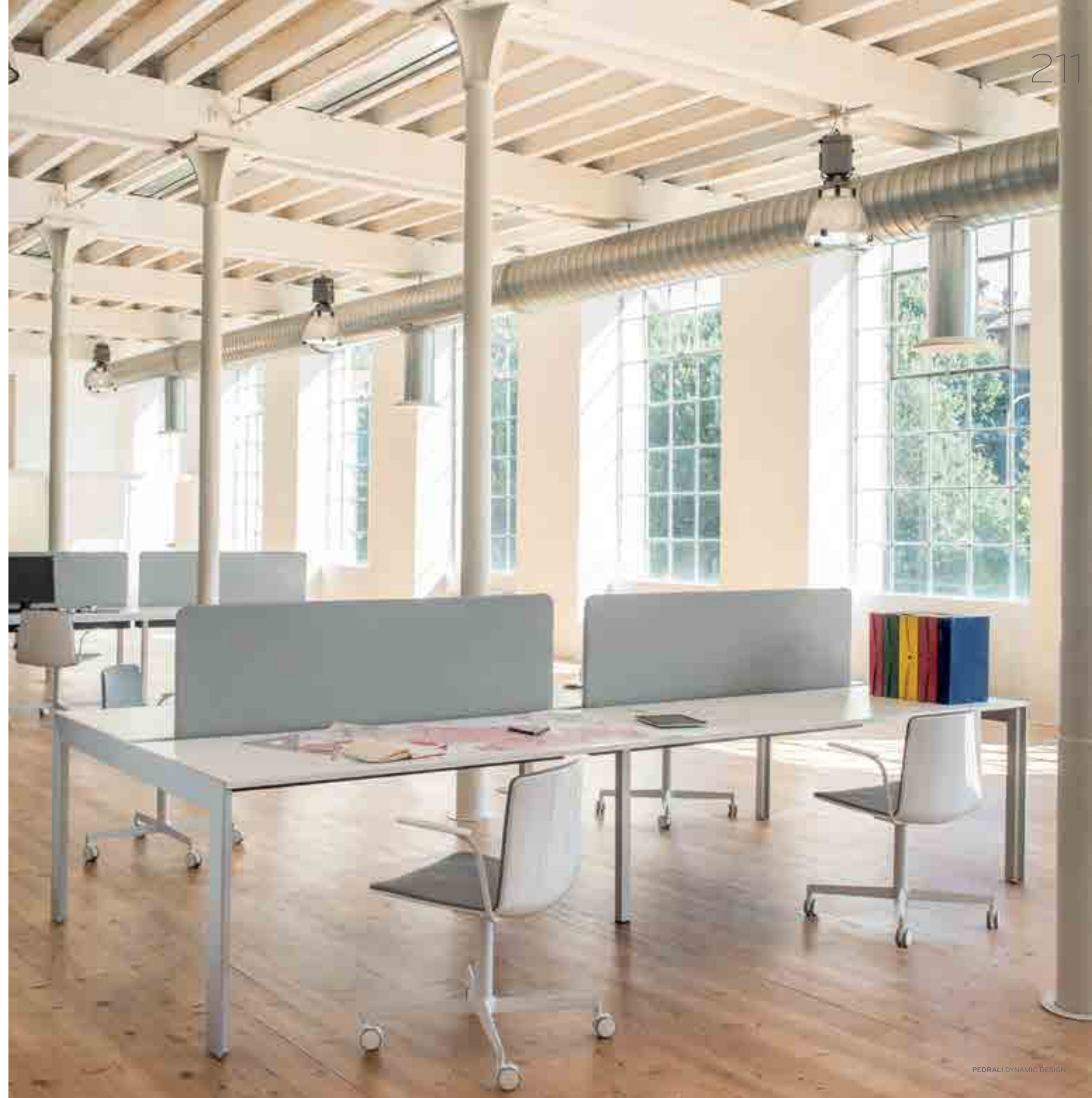

Matrix Outdoor (Art. TMD_200X86) ha struttura in alluminio anodizzato e ripiano a doghe in compact full color bianco, ideale per l'esterno. Poltrone Mya.
 Matrix Outdoor (Art. TMD_200X86) with anodized aluminium legs and leaves in Solid laminate white Compact Full Colour. Ideal for outdoor use. Mya armchairs.

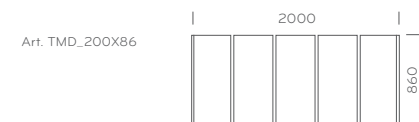

finiture struttura:
frame finishes:



AA

colore ripiano:
laminato colour:



CFC_BI



Design Daniele Lo Scalzo Moscheri

Tavolo Aero, base in acciaio verniciato bianco finitura opaca, ripiano in mdf bianco opaco spessore 30 mm con bordo inclinato.
 Aero table, white lacquered steel base in matt finish, mdf matt white top with chamfered edge 30 mm thickness.

Art. TAE_220X106

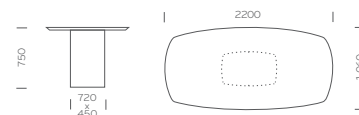

Art. TAE_130X130

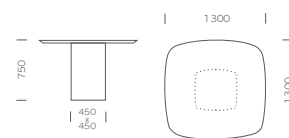

216 Aero

Tavolo Aero, base in acciaio laccato nero lucido, ripiano in vetro temperato fumè spessore 12 mm, bordo molato.
Aero table, glossy black lacquered steel base, smoke grey tempered glass top thickness 12 mm, chamfered edge.

Finiture MDF:
MDF finishes:



BI

Finiture vetro:
Glass finishes:



FUM

Finiture base:
Base finishes:



BI



NERO



217



Malmö

Allungabile
Extensible

Design Michele Cazzaniga, Simone Mandelli, Antonio Pagliarulo

Art. TML_190X90

Il tavolo allungabile Malmö ha gambe in frassino, disponibile nelle finiture sbiancato o tinto nero, abbinato a ripiano in stratificato o impiallacciato.
Malmö extensible table has ash wooden legs in bleached or black stained finish matched with solid laminate or ash veneered table top.

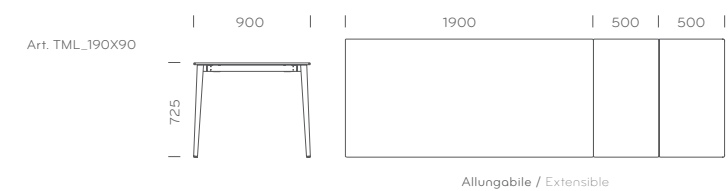

Art. TMLF

Il tavolo Malmö nella versione fissa è disponibile in 3 dimensioni. Gambe in frassino nelle finiture sbiancato o tinto nero e ripiano in stratificato.
Malmö fixed table, three dimensions available. Ash wooden legs in bleached ash or black stained finish matched with solid laminate top.

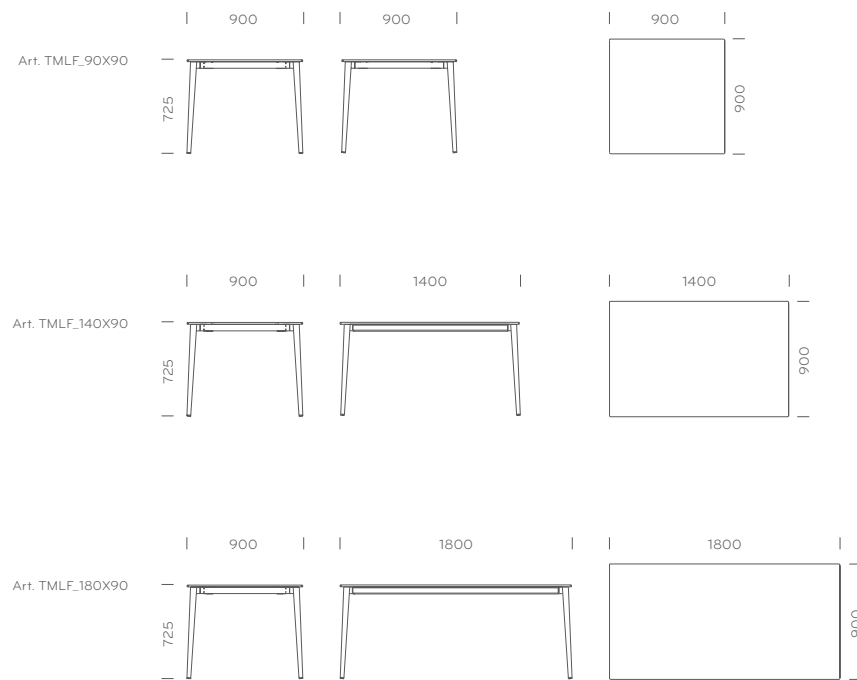

TMLF_180X90

Art. MLT

Coffee tables con ripiano in mdf laccato, impiallacciato frassino o stratificato. Gambe in massello di frassino tornite.
Coffee tables with lacquered mdf top, ash veneered top or solid laminate tops. Tapered legs in ash wood.

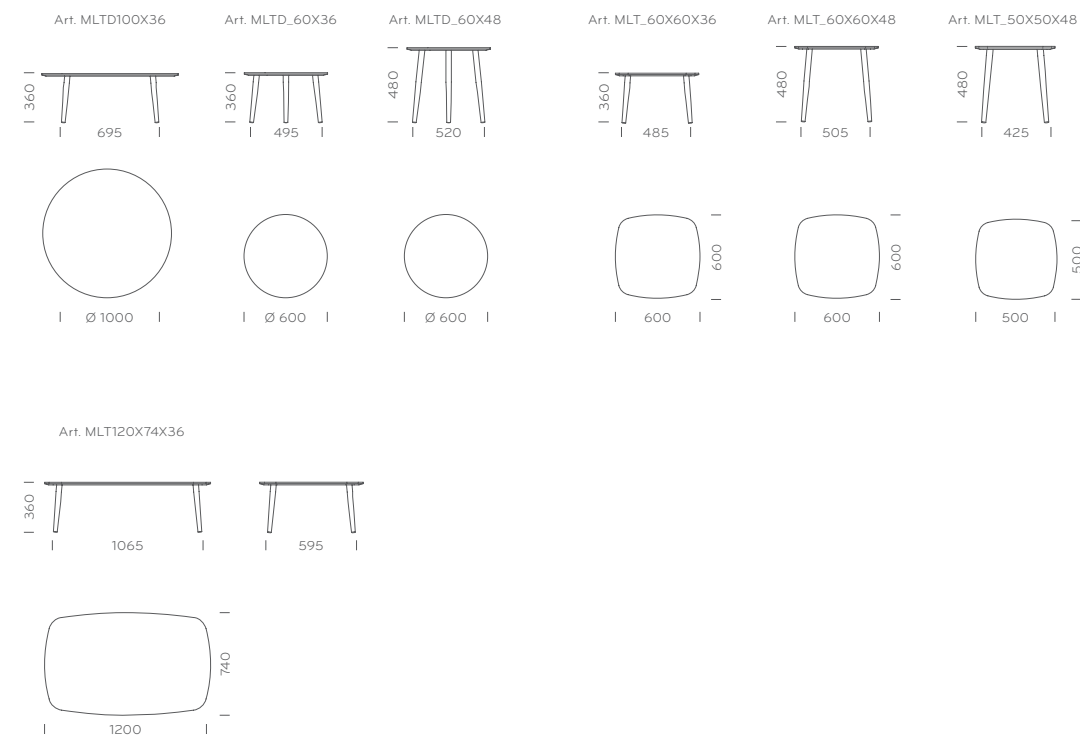

MLT120X74X36

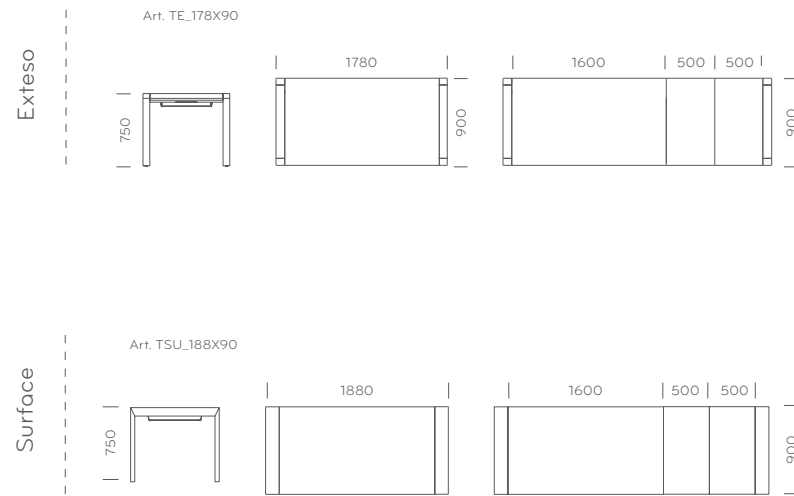

226 Exteso

Design Pedrali R&D

Tavolo Exteso allungabile in rovere sbiancato, tinto wengé o faggio laccato bianco goffrato. Piano d'appoggio impiallacciato, gambe in massello dalla forma quadrata rastremata verso terra. Le guide telescopiche in alluminio permettono la facile estrazione delle due allunghe, ciascuna delle quali ha lunghezza di 500 mm. Il particolare sistema di ruote permette di far scivolare le gambe che rimangono sempre all'estremità del tavolo, consentendo la massima funzionalità degli spazi.

Exteso extensible table, oak veneered bleached oak or wenge stained, or white matt lacquered beech wood. Veneered top, solid square and tapered legs. Aluminium sliding rail guides and two leaves (500 mm length each) allow to extend easily the table up to 2.78 meter. The wheeling system makes the legs slide towards the external sides of the table, allowing maximum functionality.



finiture struttura:
frame finishes:

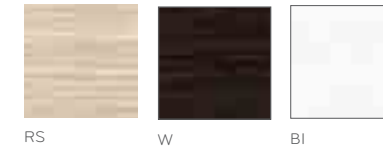

Versione laccato bianco.
White lacquered version.



Versione rovere sbiancato.
Bleached oak version.

228 Surface

Design Daniele Lo Scalzo Moscheri

finiture struttura:
frame finishes:

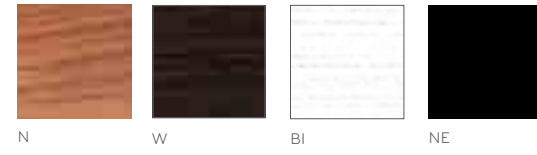



Tavolo Surface allungabile, impiallacciato rovere tinto wengé, tinto wengé nero, impiallacciato noce canaletto o in faggio laccato bianco goffrato. Il terminale e le gambe sono a forte spessore con sezione rastremata, donano quindi leggerezza formale mantenendo le doti di resistenza e stabilità del tavolo. Le guide telescopiche in alluminio permettono la facile estrazione delle due allunghe, ciascuna delle quali ha lunghezza di 500 mm. Il particolare sistema di ruote permette di far slittare le gambe che rimangono sempre all'estremità del tavolo, consentendo la massima funzionalità degli spazi.

Surface extendable table, oak veneered wenge and black wenge stained, walnut veneered finish or white laquered beech wood. Thick and tapered legs give to the table both stability and a touch of lightness. Aluminium sliding rail guides, two leaves (500 mm length each) allow to extend easily the table up to 2.88 meter. The wheeling system makes the legs slide towards the external sides of the table, allowing maximum functionality.

232 Plano2

Design Pedrali R&D

Plano 2 è una collezione di tavoli per ufficio dall'estetica asciutta ed essenziale. Il ripiano ultrasottile in stratificato poggia su un supporto in estruso di alluminio fissato alle basi quadrate. Disponibile in tre diverse dimensioni con e senza canalina passacavi. Le due basi quadrate possono essere in acciaio inox satinato o verniciato bianco.

Plano 2 is a collection of tables for the office with a thin and essential aesthetics. The ultra-thin solid laminate top lies on an extruded aluminium frame fixed to the two square bases. Available in three different sizes with and without cable management. The two square bases can be in brushed stainless steel or white powder coated.

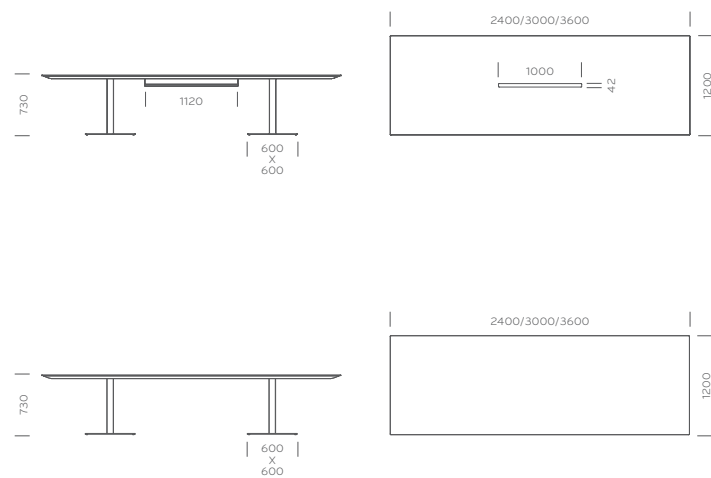

colore ripiano:
laminated colour:



CFC_BI

finiture struttura:
frame finishes:



BI



AC



234 Plano

Design Pedrali R&D

Art. PLR_300X120

Il tavolo Plano è una soluzione di prestigio e qualità ideale per l'ufficio. Plano si compone di ripiani sottili e compatti dalle geometrie essenziali e da basi in acciaio inox satinate. Un abbinamento di materiali performanti e di qualità, che rispondono ad esigenze estetiche e funzionali. Plano è proposto in diverse versioni con ripiani rettangolari o "ovali" abbinati a basi in acciaio inox satinato tonde o quadrate. Grazie alla canalina opzionale elettrificabile in estruso di alluminio, Plano diventa un vero e proprio tavolo operativo per ufficio. Top max 3600X1400 mm.

Plano, a prestigious office solution. Made of performing and quality materials, Plano is able to fulfil the most demanding expectations in terms of look and functionality. It is available in different versions: with rectangular or "oval" table top, combined with round or square brushed stainless steel table bases. With the optional desk cable management electrified extruded aluminum, Plano becomes a real desk to the office. Top max 3600X1400 mm.

Art. PLR_240X120/140

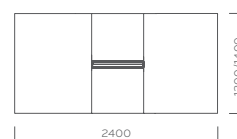

Art. PLO_240X120/140

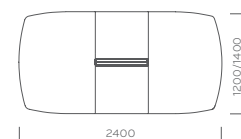

Art. PLR_300X120/140

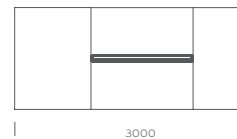

Art. PLO_300X120/140

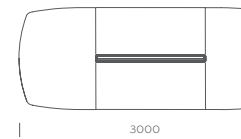

Art. PLR_360X120/140

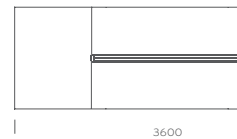

Art. PLO_360X120/140

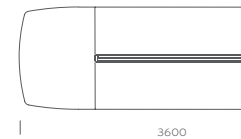

235



SET_POCKET

Set_Pocket

Set composto da tre tavolini con altezza diversa impilabili uno all'altro.
Struttura in tubo d'acciaio satinato 20x20 mm e top in laminato spessore 20 mm disponibile avorio, wengé o rovere sbiancato.
Three low tables set, with different heights, stackable.
Satinized steel tube 20x20 mm and laminate top thickness 20 mm, available ivory, wenge or bleached oak.

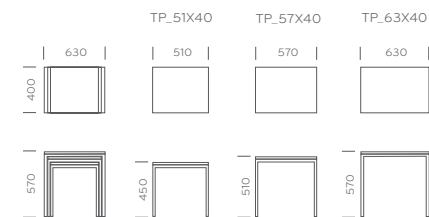

finiture struttura:
frame finishes:



ST

colore ripiano:
top colour:



1813_244

386

312



4402 H500

4401 H500

Inox

Tavolino in acciaio inox satinato o lucidato, ripiano in laminato con bordo in ABS spessore 50 mm.
Inox low table brushed or polished stainless steel, laminate top with abs edge thickness 50 mm.



finiture struttura:
frame finishes:

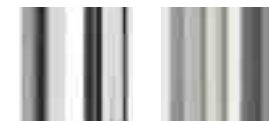

LU

AC

solo per 4401
only for 4401

colore ripiano:
top colour:



1813_244

312

386

Art. TST_45X45



Side-Table

Tavolino con struttura in tubo d'acciaio satinato e ripiano in laminato da spessore 20 mm; nei colori wengé, rovere sbiancato ed avorio.
Low side table with satinized steel tube frame and laminate top thickness 20 mm; available wenge, bleached oak or ivory colour.

colore ripiano:
top colour:



1813_244

386

312



TST_45X45

238 Set Pocket White

Design Pedrali R&D

Art. 5800

Versione Set Pocket con telaio in tubo d'acciaio verniciato bianco Ø 16 mm e ripiano in straticato Compact Full Colour bianco, spessore 10 mm.

Set Pocket version with white powder coated steel tube frame Ø 16 mm and white Compact Full Colour top, thickness 10 mm.

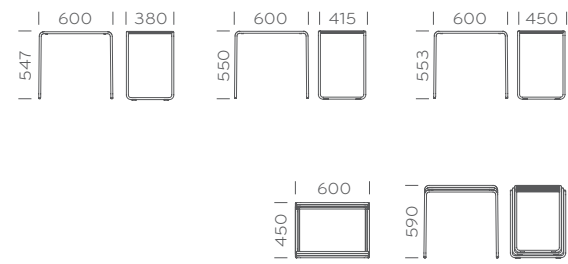

5800



Art. 5900

Versione Side Table con telaio in tubo d'acciaio verniciato bianco Ø 16 mm e ripiano in metacrilato bianco, spessore 6 mm.

Side Table version with white powder coated steel tube frame Ø 16 mm and white methacrylate top, thickness 6 mm.

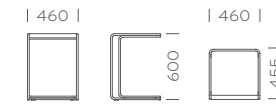

5900

Side Table White 239

Design Pedrali R&D



240 Code

Design Pedrali R&D

Code è una famiglia di tavolini ideali per arredare zone lounge e le hall degli hotel. Ripiano in stratificato 10 mm bianco o nero, telaio in tubo quadrato 20x20 mm verniciato in tinta. Code is a collection of coffee tables particularly suitable for lounge areas and hotel halls. White or black solid laminate top 10 mm, steel rod frame 20x20 mm powder coated in the same colour of the top.

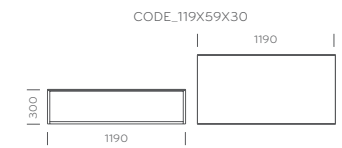
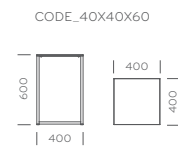
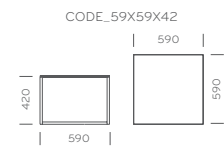
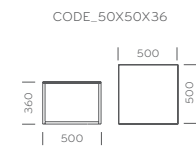
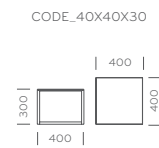

finiture struttura:
frame finishes:



BI

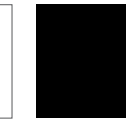

NERO

colore ripiano:
top colour:



Bianco - White



Nero - Black



242 Parenthesis

Design Claudio Dondoli and Marco Poggi

Due parentesi tonde che prendono forma per creare elementi geometrici. Contenitore a giorno o comodo piano, coffee table o comodino: Parenthesis è un elemento d'arredo versatile adatto a diversi contesti. I fianchi sono in multistrato di rovere mentre i ripiani in stratificato o mdf laccato.

Two round brackets that create geometric elements. Coffee table or useful top, day container or bedside table: Parenthesis is a versatile furniture object suitable for different contexts. The lateral sides are made of plywood oak and the tops of solid laminate or mdf lacquered.

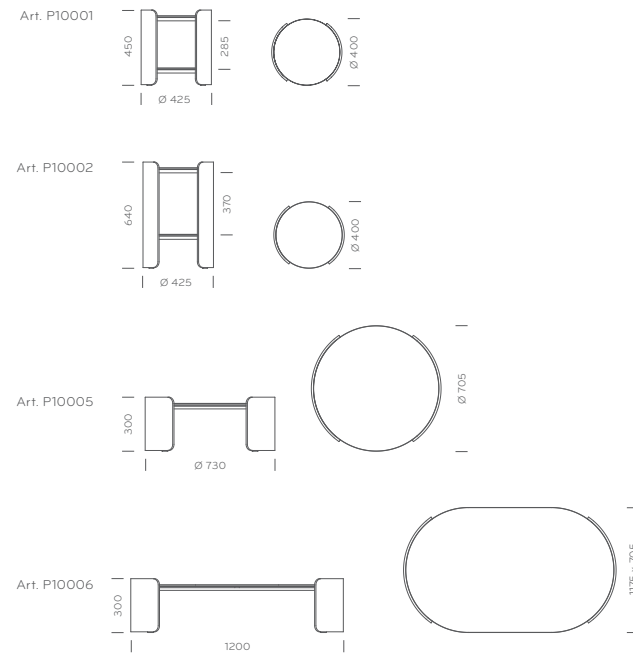

P10001

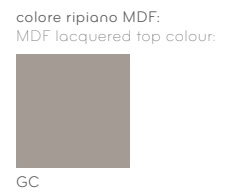

244 Wow Low Tables

Design Marco Pocci and Claudio Dondoli

Tavolino in polietilene con ripiano in metacrilato bicolore. Il tavolino può essere contenitore e se capovolto anche sgabello con o senza base cromata.
 Polyethylene low table with methacrylate bicoloured top. Wow low table can be used as a storage and once upturned - also as a stool, with or without chromed base.



470-472

480-483

480-482



Tavolino luminoso in polietilene con ripiano in metacrilato. Il vano interno contiene oltre all'interruttore di accensione una doppia presa in grado di alimentare dispositivi elettrici portatili. Il ripiano opalino permette di nascondere i cavi di alimentazione.
 Luminous polyethylene low table with methacrylate top. Inside it contains a double socket for portable electrical devices. The methacrylate opaline top allows to hide the electrical cables.

Tavolino Contenitore luminoso
 low table / storage

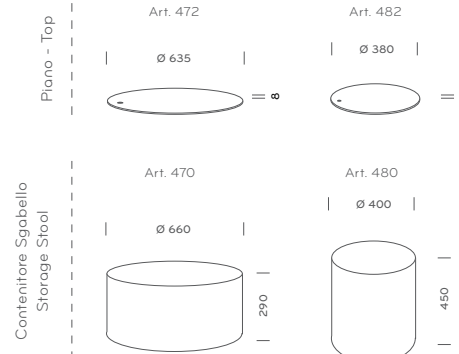
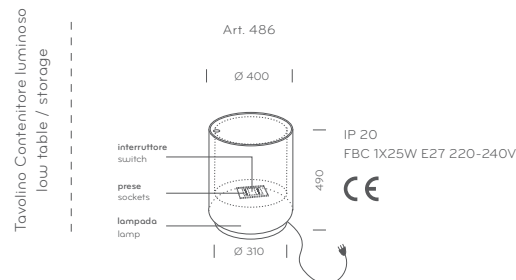

486

Ypsilon

Base in pressofusione di alluminio e colonna in estruso di alluminio
Die-Casted aluminium base and extruded aluminium column
Base en fusion d'aluminium et colonne en extrudé d'aluminium
Aluminiumguss Basis und Säule aus stranggepresstem Aluminium
Base en fundición de aluminio y columna de extrusión de aluminio

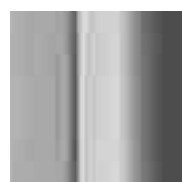

AA - Alluminio anodizzato
Anodized aluminium



ALE - Verniciato alluminio per esterno
Powder coated for outdoor



NERO - Verniciato nero
Black powder coated



BIE - Verniciato bianco per esterno
White powder coated for outdoor



LU - Alluminio lucidato
Polished aluminium



BI - Verniciato bianco
White powder coated

Ypsilon 4

Base in pressofusione di alluminio e colonna in estruso di alluminio
Die-Casted aluminium base and extruded aluminium column
Base en fusion d'aluminium et colonne en extrudé d'aluminium
Aluminiumguss Basis und Säule aus stranggepresstem Aluminium
Base en fundición de aluminio y columna de extrusión de aluminio



ALE - Verniciato alluminio per esterno
Powder coated for outdoor



NERO - Verniciato nero
Black powder coated

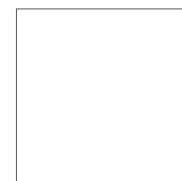

BIE - Verniciato bianco per esterno
White powder coated for outdoor



LU - Alluminio lucidato
Polished aluminium



BI - Verniciato bianco
White powder coated

Plastic-X

Base in polipropilene
Polypropylene base
Base en Polypropilène
Sockel aus Polypropylen
Base en polipropileno

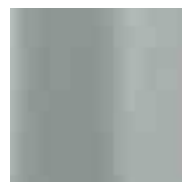

PP - Polipropilene
Polypropylene

Colonna in acciaio verniciato alluminio goffrato per esterni
Textured aluminium powder coated steel column
Colonne en acier époxy aluminium gaufré pour extérieur
Säule aus Edelstahl Aluminium lackiert
Column en acero barnizado aluminio gofrado para exterior



AGE - Verniciato alluminio goffrato per esterno
Textured aluminium powder coated for outdoor

Zenith

Acciaio inox satinato
Brushed Stainless Steel - Acier inox brossé
Inox Edelstahlmatt - Acero inoxidable



AC - Acciaio Inox satinato
Brushed Stainless Steel

Krystal

Base in ghisa ricoperta da un copribase in acciaio inox
Cast-iron base covered by a stainless steel cover-plate
Base en fonte avec couvre socle en acier inox
Gusssockel bedeckt mit einer Abdeckung aus Edelstahl
Base en hierro fundido con cubre base en acero inox



AC - Acciaio inox satinato
Brushed Stainless Steel



LU - Acciaio inox lucidato
Polished Stainless Steel

Colonna in metacrilato stampato
Methacrylate injected column
Colonne en méthacrylate moulé
Säule aus Methacrylat gemoldet
Column en metacrilato moldeado



TR - Trasparente
Transparent



NE - Nero
Black



BI - Bianco
White



ORO - Oro
Gold

Kuadro



ST - Acciaio satinato
Satinized Steel

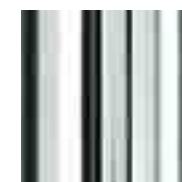

CR - Acciaio cromato
Chromed Steel



NERO - Verniciato nero bucciato
Hammered black powder coated



BI - Verniciato bianco goffrato
Textured white powder coated



AG - Verniciato alluminio goffrato
Textured aluminium powder coated



AL - Verniciato alluminio
Aluminium powder coated

Togo



BIE - Verniciato bianco per esterno
White powder coated for outdoor



NERO - Verniciato nero
Black powder coated



AS - Alluminio satinato
Satinized aluminium

Code



BI - Verniciato bianco
White powder coated



NERO - Verniciato nero
Black powder coated



LU - Alluminio lucidato
Polished aluminium

BIE - Verniciato bianco per esterno
White powder coated for outdoor

BI - Verniciato bianco
White powder coated

NERO - Verniciato nero
Black powder coated

Magic_Space



AC - Acciaio Inox satinato
Brushed Stainless Steel

Logico

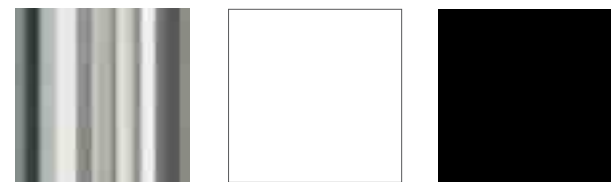

AC - Acciaio Inox satinato
Brushed stainless steel

BIE - Verniciato bianco per esterno
White powder coated for outdoor

NERO - Verniciato nero
Black powder coated

Matrix



AA - Alluminio anodizzato
Anodized aluminium

BI - Verniciato bianco
White powder coated

NERO - Verniciato nero
Black powder coated

Aero

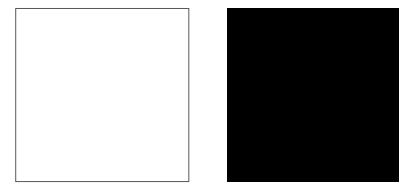

BI - Verniciato bianco
White powder coated

NERO - Verniciato nero
Black powder coated

Jump



BIE - Verniciato bianco per esterno
White powder coated for outdoor

NERO - Verniciato nero
Black powder coated

LU - Alluminio lucidato
Polished aluminium

Arki-Table



BI - Verniciato bianco
White powder coated

NERO - Verniciato nero
Black powder coated

BIE - Verniciato bianco per esterno
White powder coated for outdoor

Cast-iron and steel powder coated for indoor - Fonte et acier epoxy pour l'interieur
Gusseisen und Stahl lackiert fuer innenBereich - Hierro fundido y acero barnizado para interior



NERO - Nero, finitura bucciata
Black, hammered finish

BI - Bianco, finitura goffrata
White, textured finish

AG - Alluminio, finitura goffrata
Aluminium, textured finish

GN - Grigio naturale, finitura goffrata
Natural grey, textured finish

AL - Alluminio, finitura liscia
Aluminium, smooth finish

9007 - Alluminio, finitura opaca
Aluminium, matt finish



SK - Sabbia, finitura goffrata
Beige, textured finish

RO - Rosso, finitura goffrata
Red, textured finish

AR - Arancio, finitura goffrata
Orange, textured finish

GA - Grigio antracite, finitura goffrata
Anthracite grey, textured finish

BE - Beige, finitura goffrata
Beige, textured finish

TR - Verniciatura trasparente opaca, finitura liscia
Transparent matt powder coated, smooth finish



AV - Avario, finitura goffrata
Ivory, textured finish

MG - Marrone, finitura goffrata
Brown, textured finish

VG - Verde, finitura goffrata
Green, textured finish

GB - Grigio, finitura bucciata
Grey, hammered finish

RU - Ruggine, finitura goffrata
Rust, textured finish

527 - Grigio argento, finitura goffrata
Silver grey, textured finish

Ghisa e acciaio verniciato per esterno

Cast-iron and steel powder coated for outdoor - Fonte et acier finition pour l'exterieur
Gusseisen und stahl lackiert fuer aussen bereicht - Hierro fundido y acero barnizado para exterior



NPE - Nero per esterno, finitura goffrata
Black for outdoor, textured finish

ALE - Alluminio per esterno, finitura liscia
Aluminium for outdoor, smooth finish

6005E - Verde per esterno, finitura liscia
Green for outdoor, smooth finish

GNE - Grigio naturale per esterno, finitura goffrata
Natural grey for outdoor, textured finish

BIE - Bianco per esterno, finitura goffrata
White for outdoor, textured finish

527E - Grigio argento per esterno, finitura goffrata
Silver grey for outdoor, textured finish

Base in ghisa ricoperta da un copribase in acciaio inox
 Cast-iron base covered by a stainless steel cover-plate
 Base en fonte avec couvre socle en acier inox
 Gusssockel bedeckt mit einer Abdeckung aus Edelstahl
 Base en hierro fundido con cubre base en acero inoxidable

Base in lamiera di acciaio per gli articoli 4491, 4492, 4497, 4499, 4493, 4494, 4431/KR
 Steel plate base for items 4491, 4492, 4497, 4499, 4493, 4494, 4431/KR
 Base en tôle d'acier pour les articles 4491, 4492, 4497, 4499, 4493, 4494, 4431/KR
 Sockel aus Plättchen fuer Artikel 4491; 4492; 4497, 4499, 4493, 4494, 4431/KR
 Base en chapa de acero para los articulos 4491, 4492, 4497, 4499, 4493, 4494, 4431/KR

Colonna in tubo di acciaio inox
 Stainless steel tube column
 Colonne en tube d'acier inox
 Säule aus Inox edelstaht Rohr
 Columna en tubo de acero inoxidable

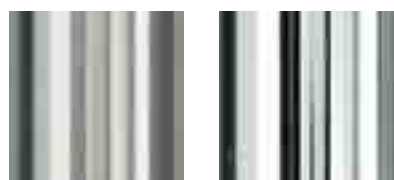

AC - Acciaio inox satinato
Brushed Stainless Steel
 LU - Acciaio inox lucidato
Polished Stainless Steel



OA - Ottone anticato satinato
Matt antique brass
 RM - Rame anticato satinato
Matt antique copper
 BS - Bronzo anticato satinato
Matt antique bronze
 EC - Effetto corten
Corten

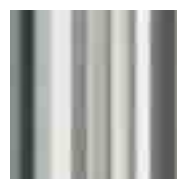

AC 316 - Acciaio inox Aisi 316 per esterno solo su:
 Art. 4151/AC - 316 - 4421/AC-316
 Brushed stainless steel Aisi 316 for outdoor.
 Only for Art. 4151/AC - 316 - 4421/AC-316



AS - Alluminio anodizzato satinato solo per colonna:
 Art. 4441/AS - 4462/AS - 4444/AS - 4466/AS
 Anodized aluminium only for column:
 Art. 4441/AS - 4462/AS - 4444/AS - 4466/AS

Tubo in acciaio cromato e satinato

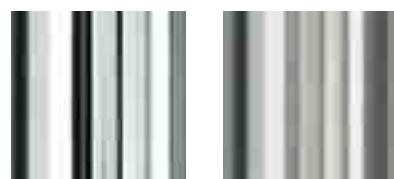

CR - Acciaio cromato
Chromed steel
 ST - Acciaio satinato
Satinized steel

Finiture legno

Wooden finishes - Finitions bois - Holz farben - Acabados madera

Faggio

Colonne in faggio massiccio per gli articoli Oliva, Linea, Jimmy, Freddy, Inox-FX
 Solid beech wood columns for items Oliva, Linea, Jimmy, Freddy, Inox-FX
 Colonne en hêtre massif pour les articles Oliva, Linea, Jimmy, Freddy, Inox-FX
 Massiv Holzsäulen fuer Artikel Oliva, Linea, Jimmy, Freddy, Inox-FX
 Columnas en haya maciza para los articulos Oliva, Linea, Jimmy, Freddy, Inox-FX



FA - Faggio naturale
Natural beech
 W - Wengé
Wenge stained
 N - Noce
Walnut stained
 C - Ciliegio
Cherry stained



C2 - Ciliegio 2
Cherry 2 stained
 M - Magano
Mahogany stained
 M2 - Magano 2
Mahogany 2 stained

Rovere

Colonne in tubo impiallacciato rovere - (per basamenti Inox)
 Oak veneered tube columns - (for Inox table bases) - Colonne en tube plaqué en chêne (pour les piétements Inox)
 Furnierte Eiche Säule - Columnas en tubo contrachapado de roble (para pies de mesa Inox)

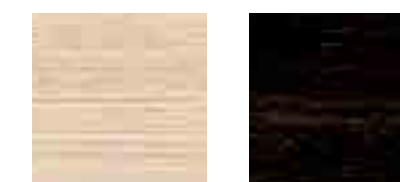

RS - Rovere sbiancato
Bleached oak
 W - Wengé
Wenge stained

Exteso



W - Wengé
Wenge stained
 RS - Rovere sbiancato
Bleached oak
 BI - Faggio laccato bianco goffrato
White textured laquered beech

Malmö



FR - Frassino sbiancato
Bleached ash
 AN - Frassino tinto nero
Black stained ash

Surface

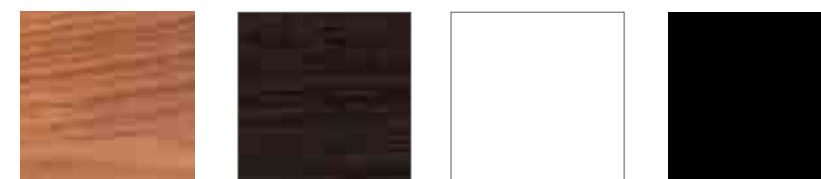

N - Noce canaletto
Walnut
 W - Wengé
Wenge stained
 BI - Faggio laccato bianco goffrato
White textured laquered beech
 NE - Wengé nero
Black wenge stained

MANUTENZIONI ED AVVERTENZE

PER UN CORRETTO UTILIZZO E MANUTENZIONE DEI BASAMENTI PEDRALI SI CONSIGLIA DI SEGUIRE LE SEGUENTI AVVERTENZE:

EVITARE L'UTILIZZO DI DETERGENTI AGGRESSIVI O SOLVENTI. PULIRE CON UN PANNO UMIDO ED ASCIUGARE; EVENTUALI RESIDUI D'ACQUA POSSONO OSSIDARE LA SUPERFICIE DEL BASAMENTO.

SI RACCOMANDA DI NON FARE STRISCIARE I BASAMENTI MA DI SOLLEVARLI, PER EVITARE LA FUORIUSCITA DEI PIEDINI.

LE VITI PER IL FISSAGGIO DEI RIPIANI NON SONO FORNITE QUALORA VENGANO ORDINATI SOLO I BASAMENTI.

PEDRALI DECLINA OGNI RESPONSABILITÀ PER UN USO IMPROPRIO DEI PRODOTTI O PER EVENTUALI MODIFICHE E/O RIPARAZIONI APPORTATE DAI CLIENTI SENZA AUTORIZZAZIONE.

PEDRALI SI RISERVA LA FACOLTA' DI APPORTARE MODIFICHE O MIGLIORIE SENZA ALCUN PREAVVISO.

MAINTENANCE AND CARE INSTRUCTIONS

FOR A CORRECT USE AND MAINTENANCE OF PEDRALI'S TABLE BASES, THE FOLLOWING CARE INSTRUCTIONS ARE SUGGESTED

CLEAN WITH A DAMP CLOTH AND DRY. DO NOT USE AGGRESSIVE DETERGENTS OR SOLVENTS.

WATER OR SOLVENTS LEFTOVERS CAN OXIDIZE THE SURFACE OF THE TABLE BASE.

DO NOT DRAG THE BASE BUT LIFT IT TO AVOID THE LOSS OF FEET.

ORDERS FOR TABLE BASES ONLY ARE SUPPLIED WITHOUT SCREWS FOR TOP FIXING.

PEDRALI DENIES ANY RESPONSABILITY FOR AN IMPROPER USE, CHANGES, OR REPAIRS OF THE PRODUCTS MADE BY CUSTOMERS WITHOUT PRIOR AUTHORIZATION.

PEDRALI RESERVES THE RIGHT TO MODIFY OR UPGRADE THE PRODUCT WITHOUT PRIOR NOTICE.

ENTRETIEN ET AVERTISSEMENTS

POUR UNE UTILISATION ET UN ENTRETIEN CORRECTS DES PIÈTEMENTS PEDRALI ON CONSEILLE DE SUIVRE LES AVERTISSEMENTS SUIVANTS:

NETTOYER AVEC UN CHIFFON HUMIDE ET ESSUYER.

EVITER L'UTILISATION DE DETERGENTS AGRESSIFS OU DE SOLVANTS. LES RESIDUS EVENTUELS D'EAU PEUVENT OXYDER LA SURFACE DU PIÈTEMENT.

ON RECOMMANDE DE NE PAS TRAINER LES PIÈTEMENTS MAIS DE LES SOULEVER A FIN D'EVITER LA PERTE DES PATINS.

LES COMMANDES POUR SEULS PIÈTEMENTS SERONT FOURNIS SANS LA VISSERIE POUR LA FIXATION DES PLATEAUX.

PEDRALI DECLINE CHAQUE RESPONSABILITE POUR LES EVENTUELLES MODIFICATIONS APORTEES AUX PIÈTEMENTS.

PEDRALI SE RESERVE LA FACULTE D'APORTER DES MODIFICATIONS OU AMELIORATIONS SANS AUCUN PREAVIS.

BEHAUPTUNG UND WARNUNGEN

FÜR KORREKTE VERWENDUNG UND INSTANDHALTUNG DER PEDRALI TISCHGESTELLEN, EMPFEHLEN WIR, FOLGENDE

ANWEISUNGEN ZU BEFOLGEN: REINIGEN MIT EINEM FEUCHTEN TUCH UND SOFORT TROCKNEN.

VERMEIDEN DIE VERWENDUNG VON AGGRESSIVEN REINIGUNGS ODER LÖSUNGSMITTEL.

EVENTUELLE WASSERRÜCKSTÄNDE KÖNNEN DIE OBERFLÄCHE DES TISCHGESTELLES OXIDIEREN.

WIR EMPFEHLEN, DIE TISCHGESTELLEN NICHT ZU SCHLEPPEN, SONDERN SIE AUFZUHEBEN, UM DER AUSTRITT DER GLEITER ZU VERMEIDEN.

SOLLTEN NUR TISCHGESTELLEN BESTELLT WERDEN, DANN WERDEN SCHRAUBE FÜR TISCHPLATTE NICHT GELIEFERT.

PEDRALI LEHNT JEGLICHE VERANTWORTUNG FÜR MISSBRÄULICHE VERWENDUNG ODER EVENTUELLE VERÄNDERUNGEN ODER NICHT VON PEDRALI AUTORISIERT SIND.

PEDRALI BEHALTET SICH DAS RECHT VOR, OHNE JEGLICHE BENACHRICHTIGUNG ÄNDERUNGEN ODER VERBESSERUNGEN AN DEN PRODUKTEN ANZUBRINGEN.

MANUTENCIÓN Y ADVERTENCIAS

PARA UN USO CORRECTO Y UN BUEN MANTENIMIENTO DE LOS PIES DE MESA DE PEDRALI SE ACONSEJA DE SEGUIR LAS SIGUIENTES RECOMENDACIONES: EVITAR EL USO DE DETERGENTES O DISOLVENTES AGRESIVOS.

LIMPIAR CON UN TRAPO HÚMEDO Y SECAR.

RESIDUOS DE AGUA PUEDEN OXIDAR LA SUPERFICIE DE LOS PIES DE MESA.

SE RECOMIENDA DE LEVANTAR LOS PIES DE MESA Y DE NO ARRASTRARLOS PARA EVITAR QUE SALGAN LOS TACOS.

LOS TORNILLOS PARA FIJAR LAS ENCIMERAS NO SERAN SUMINISTRADOS EN CASO DE COMPRA DE LOS PIES DE MESA SIN LAS ENCIMERAS.

PEDRALI DECLINA CUALQUIER TIPO DE RESPONSABILIDAD EN CASO DE USO IMPROPRIO DE LOS PRODUCTOS O DE EVENTUALES MODIFICACIONES O REPARACIONES HECHAS POR PARTE DE LOS CLIENTES SIN AUTORIZACIÓN.

PEDRALI SE RESERVA EL DERECHO DE MODIFICAR O HACER MEJORIAS A SUS PRODUCTOS SIN AVISO.