

PEDRALI S.p.A.

sp 122 Mornico al Serio - 24050 BERGAMO - ITALY
Export Dept. Tel: +39 035 8358840 Fax +39 035 8358888
Ufficio Commerciale Italia Tel: +39 035 8358810 Fax +39 035 8258888

www.pedrali.it - info@pedrali.it

NOWCOMPLEMENTS 2015

PEDRALI[®]
DYNAMIC DESIGN

NOWCOMPLEMENTS 2015

NOWCOMPLEMENTS_1502

PEDRALI[®]

PARENTHESIS OPASHA PARENTHESIS OP
MALMOT FLAGOYPSILON MALMOT FLAGOY
TETRIS WASKADO ICEBERG TETRIS WASKADO
KON NOTIGLOO BRICK KON NOTIGLOO BR

NOW**COMPLEMENTS** 2015

Appendiabiti | Coat rack

NEW Flag p. 70

Voilà p. 74

Banco bar | Bar counter

Iceberg p. 50

Igloo p. 44

Tetris p. 54

Portaombrelli | Umbrella stand

Brick p. 04

Sedute modulari | Modular seating

UPDATE Ikon bench p. 40

Tavoli bassi | Low tables

UPDATE Code p. 34

UPDATE Ikon p. 38

Inox p. 62-66

Malmö p. 32

NEW Parenthesis p. 30

Pasha p. 26

Set Pocket p. 36-65

Side Table p. 37-68

Wow p. 14

Ypsilon p. 60

Ypsilon 4 p. 60

Vasi | Pots

UPDATE Kado p. 08



06 Brick

Art. BRICK - BRICK4

Brick è un portaombrelli caratterizzato da un volume puro che ha il compito di contenere con ordine, occupando il minor spazio possibile. Oggetto pratico per i giorni piovosi, è anche un modulo d'arredo per tutte le altre giornate dell'anno.

Realizzato in polietilene stampato rotazionale, ha finitura opaca antigraffio. Colori: bianco, grigio chiaro, arancio, blu, giallo e verde. Due moduli: con 10 fori (Art. BRICK) e 4 fori (Art. BRICK4).

Brick is an umbrella stand, featured by a pure volume, with the aim of containing in a tidy way and in the smallest possible space. It is a practical object for rainy days as well as a modular piece of furniture for all the other days of the year. Brick is made of rotomoulding polyethylene and it is matt and scratch resistant.

Colours: white, light grey, orange, blue, yellow and green. Two units with 10 holes (Art. BRICK) and 4 holes (Art. BRICK4).

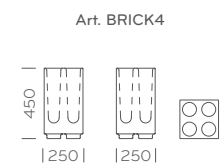
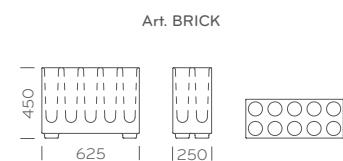

BRICK4

BRICK



08 Kado



Design Pedrali R&D

Art. KADO

Kado delimita, organizza, arreda e personalizza ogni ambiente del living e del contract. Caratterizzato da linee geometriche ed essenziali, resistente agli urti e agli agenti atmosferici, è atossico e totalmente riciclabile.

Kado, ideal solution for delimiting, furnishing, organizing every living and contract location. Featured by essential and simple lines. Shock resistant and waterproof, Kado is non toxic and recyclable.

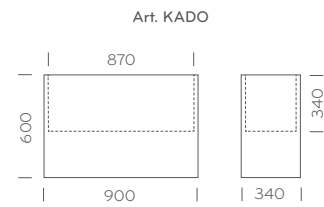

Kado è realizzato in polietilene con finitura opaca disponibile nei colori grigio antracite, grigio chiaro, bronzo e bianco.
Kado is made of polyethylene matt finish, available in anthracite grey, light grey, bronze and white colours.

09



10 Kado

Art. KADO.3

Accessoriabile con un cuscino per indoor rivestito in tessuto, vera o finta pelle, il vaso Kado diventa anche seduto.
Equipped with upholstered cushion for indoor use covered with fabric, simil leather or mid grain leather, Kado pot becomes also a seat.

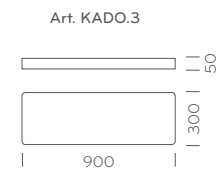

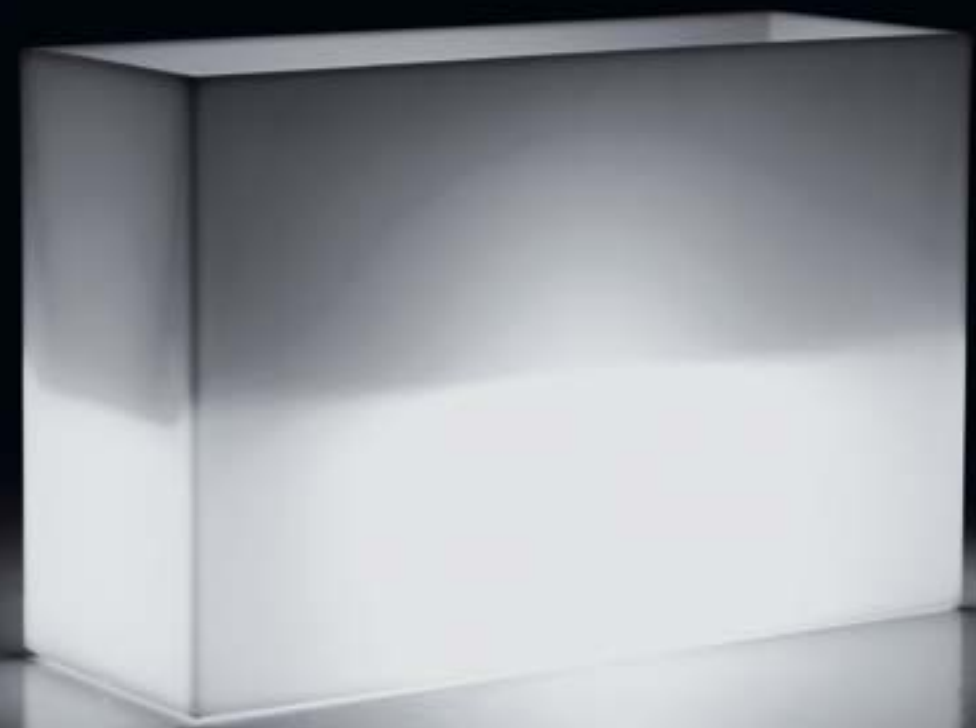

Art. KADO_LUCE

Grazie al kit luce opzionale, il vaso Kado diventa oggetto luminoso ideale per ricreare suggestive atmosfere sia negli ambienti indoor che outdoor. Disponibile a richiesta anche il kit per il fissaggio a terra.

Thanks to optional kit for luminous version, Kado flower pot becomes a lighting object ideal for creating charming atmospheres for both indoor and outdoor environments. On request, kit for floor fixing also available.

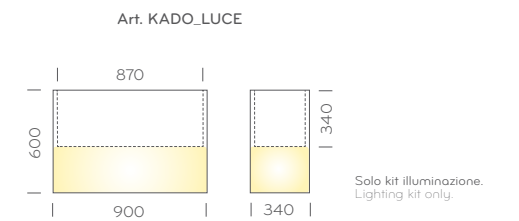

14 Wow

Design Claudio Dondoli and Marco Pocci

Art. 480 - 482 - 483 - 470 - 472 - 473

Wow pouf-sgabello in polietilene è disponibile in due dimensioni, Ø 400 mm (Art. 480) e Ø 660 mm (Art. 470). Lo sgabello può montare una base cromata, che lo rende 60 mm più alto. I colori disponibili sono bianco, nero, rosso, verde, ciclamino e giallo.

Wow polyethylene low stool is available in two different sizes, Ø 400 mm (Art. 480) and Ø 660 mm (Art. 470). Wow stool can be completed by a chromed base, so becoming 60 mm higher. Colours available: white, black, red, green, cyclamen and yellow.

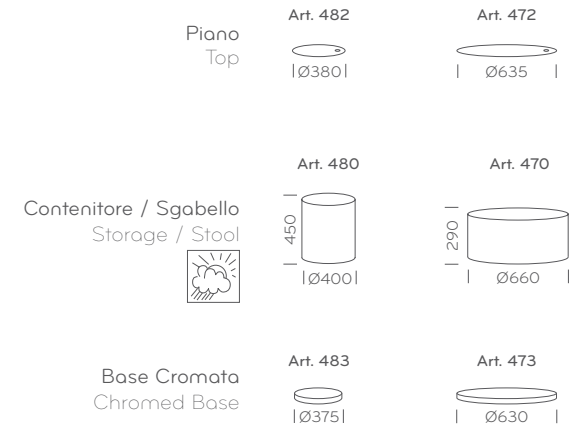

Art. 480 - 482 - 470 - 472

Wow capovolto diventa tavolino-contenitore grazie all'appoggio di un piano in metacrilato bicolore (ad esclusione del rosso monocromatico).
Once upturned, Wow becomes a low table/storage thanks to a double face methacrylate top (excluding red monochromatic version).

Art. 470 - 472



Art. 480 - 482



18 Wow tavolino contenitore luminoso luminous low table and storage

Art. 486

Tavolino e contenitore luminoso in polietilene con ripiano in metacrilato, solo per interni. Il vano interno contiene oltre all'interruttore di accensione una doppia presa in grado di alimentare dispositivi elettrici portatili. Il ripiano opalino permette di nascondere i cavi d'alimentazione e fa trasparire la luce. Fornito di lampadina a basso consumo energetico, 25 W con 6 anni di garanzia.

Luminous low table and storage in polyethylene with methacrylate top, for indoor use only. Light switch and double electrical socket for charging mobile devices. Opaline methacrylate top hides electrical cables without covering the light. Supplied with light bulb 25 W, energy-efficient, 6 years guarantee.

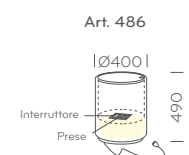

FBC 1x25W E27 220-240V
CE IP 20



486



Art. 475E - 485E

A destra sgabello luminoso per uso domestico e contract, per esterni, in polietilene bianco trasparente alla luce. L'accensione della luce interna avviene tramite collegamento diretto alla rete elettrica. Fornito di lampada 23 W a basso consumo energetico con 6 anni di garanzia. Disponibile anche nella versione Ø 660 mm con base zincata verniciata bianca.

On the right, luminous low stool for residential and contract use, suitable for outdoor use, in white transparent polyethylene. Electric cable for turning internal light on. Supplied with light bulb 23 W, energy-efficient, 6 years guarantee. Available version Ø 660 mm with zinc-coated base, hammered white powder coated.

Art. 485E

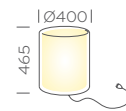

FBT 1X23W E27 220-240V
CE IP 44

Art. 475E

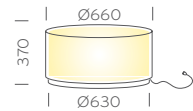

FBT 1X23W E27 220-240V
CE IP 44



485

Art. 485 - 475

A sinistra sgabello luminoso per uso domestico e contract solo per interni, in polietilene bianco trasparente alla luce. L'accensione della luce interna avviene tramite un interruttore a pedale sul cavo d'alimentazione. Fornito di lampada 23W a basso consumo energetico con 6 anni di garanzia. Disponibile anche nella versione Ø 660 mm con base verniciata bianca.

On the left, luminous low stool for residential and contract use, suitable for indoor only, in white polyethylene transparent to the light. Footswitch to turn internal light on. Supplied with light bulb 23W, energy-efficient, 6 years guarantee. Available version Ø 660 mm with white powder coated base.

Art. 485

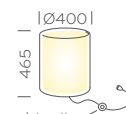

FBT 1X23W E27 220-240V
CE IP 40

Art. 475

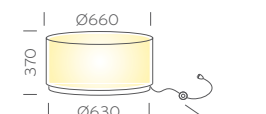

FBT 1X23W E27 220-240V
CE IP 40



485E



Art. 475L - 485L

Wow si colora di luce LED e diventa oggetto luminoso creativo. Un controller posizionato sul cavo di alimentazione consente di cambiare in successione 6 colori (rosso, giallo, verde, viola, blu e azzurro) per creare effetti scenici sorprendenti. Disponibile in 2 diverse dimensioni.

Wow as luminous object with LED light. Thanks to a controller on the cable, it is possible to change 6 colours (red, yellow, green, violet, blue and light blue) in rapid succession. Available in 2 different sizes.

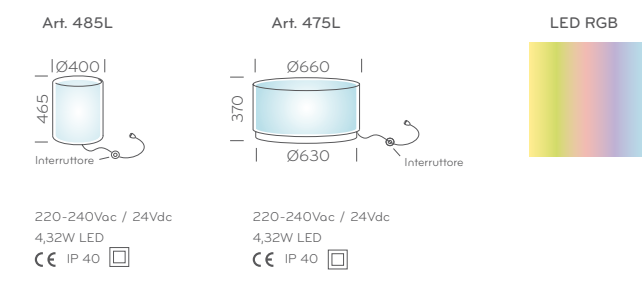

475L



485L

Design Pedrali R&D

Art. 320 - 321 - 322 - 323 - 324 - 325

Wow è un sistema di pouf dalle forme rotonde, quadrate o rettangolari che donano un tocco ironico e casual agli ambienti collettivi e domestici.

Disponibili in un'ampia scelta di tessuti e colori, presentano un'imbottitura in schiumato poliuretano ignifugo.

Wow is a system of poufs - round, square and rectangular - which give a casual and ironic touch to contract and domestic environments. Available in a wide range of fabrics and colors, the upholstery is made of fire-retardant injected polyurethane foam.

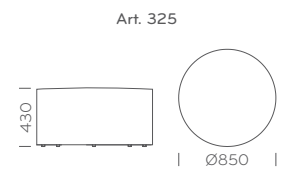
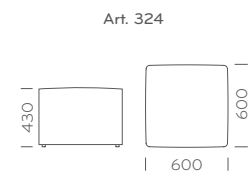
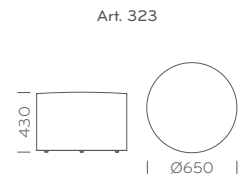
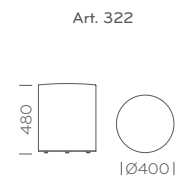
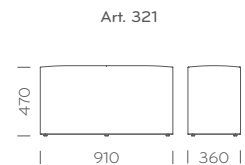
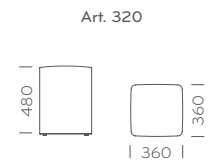

26 Pasha pouf



Design Claudio Dondoli and Marco Pucci

Art. 661

Pasha pouf: tavolino lounge o seduta. Accostabile alla poltrona o proposto come estroso complemento d'arredo indipendente, è comodo e versatile nell'utilizzo. Interamente in policarbonato finitura lucida nelle tonalità del nero per indoor oppure bianco, trasparente e fumè anche per outdoor.

Pasha ottoman, lounge table or low seat. Comfortable and versatile, it can be combined with the armchair or separately used as a fancy complement. Made of polycarbonate, glossy finish, it is available in black colour for indoor use or in white, transparent and fumè colours for outdoor use.

Art. 661

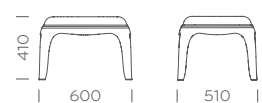



Art. 662

Il pouf Pasha diventa tavolino grazie all'applicazione di un pratico vassoio. Realizzato in resina melaminica ad alta resistenza conforme all'uso alimentare, è di facile manutenzione e movimentazione grazie alle due maniglie laterali. Disponibile in bianco (adatto anche per utilizzo outdoor) o nero full colour con finitura lucida.

The Pasha pouf becomes a low table if equipped with a practical tray. Made of high pressure melamine suitable for food use, this tray is free maintenance and easy in movements thanks to the lateral handles. Available in white (suitable also for outdoor use) or black colour, glossy finish.

Art. 661 + 662



662



661



661 + 662

30 Parenthesis

Design Claudio Dondoli and Marco Pocci

Art. P10001 - P10002 - P10005 - P10006

Due parentesi tonde che prendono forma per creare elementi geometrici. Contenitore a giorno o comodo piano, coffee table o comodino: Parenthesis è un elemento d'arredo versatile adatto a diversi contesti. I fianchi sono in multistrato di rovere mentre i ripiani in stratificato o mdf laccato.

Two round brackets that create geometric elements. Coffee table or useful top, day container or bedside table: Parenthesis is a versatile furniture object suitable for different contexts. The lateral sides are made of plywood oak and the tops of solid laminate or mdf lacquered.

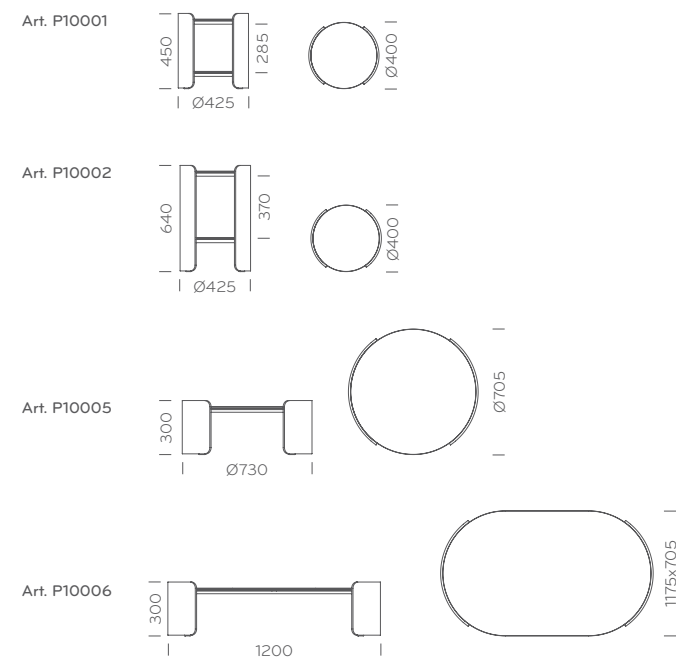

P10001



32 Malmö

Design Michele Cazzaniga, Simone Mandelli, Antonio Pagliarulo

Art. MLT

La famiglia Malmö si estende a nuovi usi contaminando gli ambienti lounge, le sale d'attesa e le aree bar. I coffee tables hanno il ripiano in mdf laccato, impiallacciato frassino o stratificato. Le gambe sono in massello di frassino tornite. Malmö family expands to new contexts entering in lounge environments, waiting areas and café. Coffee tables with lacquered mdf top, ash veneered top or solid laminate tops. Tapered legs in ash wood.

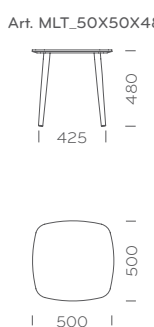
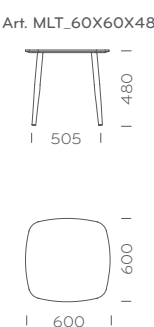
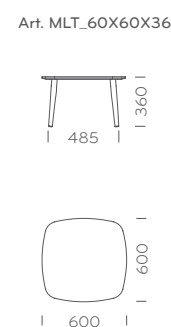
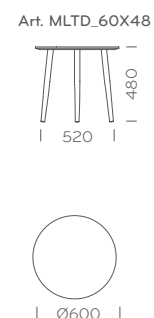
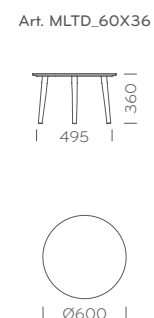
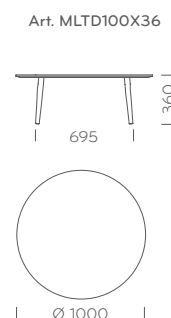
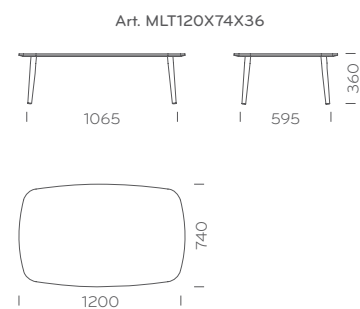

MLT120X74X36



Design Pedrali R&D

Art. CODE

Code è una famiglia di tavolini, ideali per arredare zone lounge e le hall degli hotel. Ripiano in stratificato bianco o nero spessore 10 mm, telaio in tubo quadrato 20x20 mm verniciato in tinta.

Dimensioni: 400x400x300 mm, 400x400x600 mm, 500x500x360 mm, 590x590x420 mm, 1190x590x300 mm.

Code is a collection of coffee tables particularly suitable for lounge areas and hotel halls. White or black solid laminate top 10 mm thickness, steel tube frame 20x20 mm powder coated in the same colour.

Dimensions: 400x400x300 mm, 400x400x600 mm, 500x500x360 mm, 590x590x420 mm, 1190x590x300 mm.

Art. CODE_40X40X30

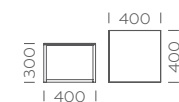

Art. CODE_40X40X60

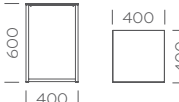

Art. CODE_50X50X36

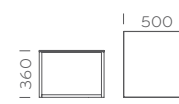

Art. CODE_59X59X42

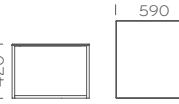

Art. CODE_119X59X30

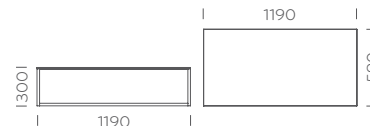

SET_CODE



CODE_40X40X60



36 Set Pocket white

Design Pedrali R&D

Art. 5800

Versione Set Pocket con telaio in tubo d'acciaio verniciato bianco Ø 16 mm e ripiano in stratificato compact full colour bianco, spessore 10 mm.

Set Pocket version with white powder coated steel tube frame Ø 16 mm and white compact full colour top, thickness 10 mm.

Art. 5800

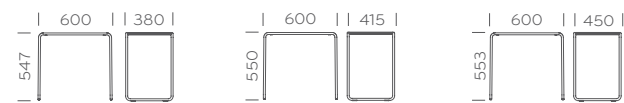

5800



37 Side Table white

Design Pedrali R&D

Art. 5900

Versione Side Table con telaio in tubo d'acciaio verniciato bianco Ø 16 mm e ripiano in metacrilato bianco, spessore 6 mm.

Side Table version with white powder coated steel tube frame Ø 16 mm and white methacrylate top, thickness 6 mm.

Art. 5900

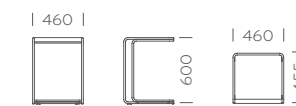

5900



Design Pio e Tito Toso

Art. 863 - 863V

Ikon parla il linguaggio dell'architettura con la sua massima semplicità e grande pulizia formale che pare uscire dai meandri del tempo. Coffee table per outdoor con basamento in polipropilene stampato ad iniezione abbinato a ripiano in stratificato o, per utilizzo indoor, abbinato a ripiano in vetro. With its timeless and clean shape, Ikon talks the architecture language. Coffee table with injected polypropylene table base. It can be combined with solid laminate top for outdoor use or glass top for indoor use.

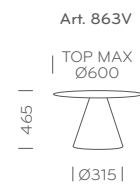
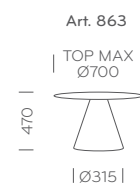

863_BI



863V_NE



865_SA



863_GC





Art. B863 - B863.4

Versatile, caratterizzata da forme semplici e da grande pulizia formale, la famiglia Ikon si arricchisce di una collezione di sedute modulari. Adatta sia per interni che per esterni, la collezione nasce dalla ricerca di sintesi, bellezza e funzionalità. Ikon bench ha base in polipropilene stampato ad iniezione e ripiano in stratificato.

Colori: bianco, grigio chiaro e sabbia per outdoor, nero solo per indoor. Due moduli disponibili. Il modulo lineare è accessorabile con cuscino per indoor imbottito con schiuma di poliuretano espanso, rivestito in tessuto o finta pelle, impreziosito da un bottone centrale.

Defined by simple shapes and clean lines, the versatile Ikon family is now enlarged with a collection of modular seating. Suitable for indoor and outdoor use, the collection comes from the research of synthesis, beauty and functionality. Ikon bench has injected moulding polypropylene base and solid laminate top.

Colours: white, light grey and beige for outdoor, black for indoor use only. Two modular versions available. Optional for linear module: indoor cushion upholstered with polyurethane foam covered with fabric or simil leather with a central button.

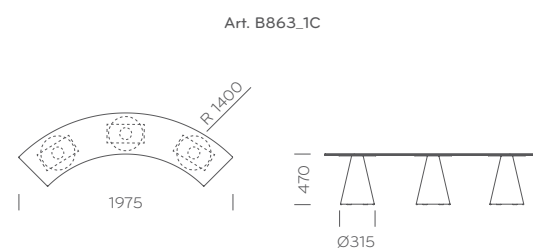
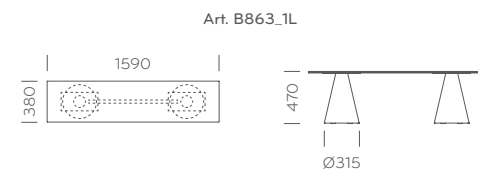

Alcune possibili configurazioni / Some possible combinations:

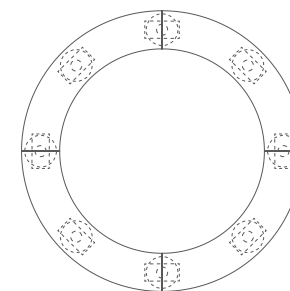

Art. B863C_4C

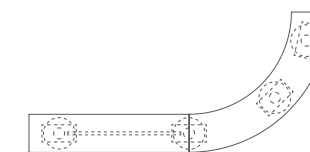

Art. B863_LC

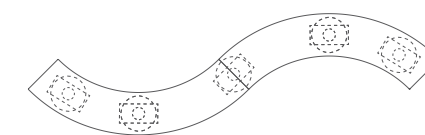

Art. B863_2C



B863_1L + B863.4



B863_1C





Art. IGL_BI/RIP_BI - IGLC_CORNER

Igloo è un bancone da bar realizzato in polietilene stampato rotazionale. Di colore bianco opalino, è facile da spostare e resistente agli urti.

E' abbinato ad un piano di lavoro in lamiera. Opzionali: mensole interne, top superiore in metacrilato bianco e impianto interno di illuminazione. Disponibile il modulo angolare in abbinamento al lineare per ricreare diverse configurazioni d'arredo.

Igloo is a modular bar counter made of rotomoulded polyethylene with steel top. White opaline, easy to move and scratch-resistant.

Optional: inner shelves, upper top in white methacrylate and lighting system. Corner unit also available to be used in combination with the linear one to create several furnishing configurations.

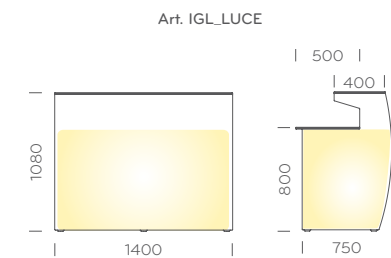
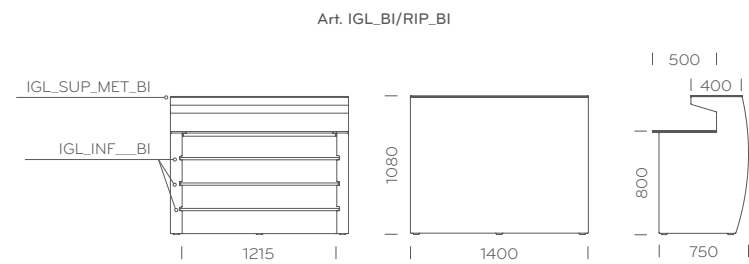

Solo kit illuminazione.
Lighting kit only.

Art. IGLC_CORNER

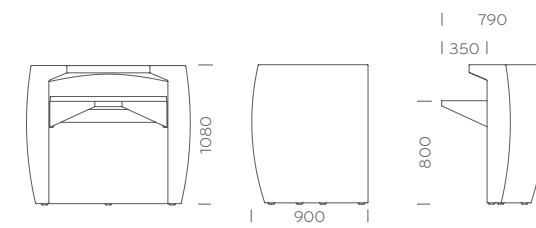

Art. IGLC_LUCE

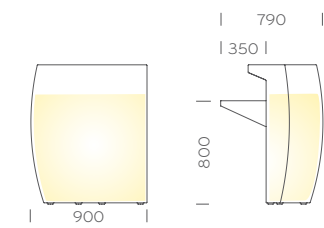

Solo kit illuminazione.
Lighting kit only.





Art. IGLC_CONSOLLE

Igloo Consolle completa la serie di banconi Igloo. Pratica e funzionale, si compone di 2 moduli in polietilene uniti da un ripiano di lavoro in acciaio verniciato bianco.

Accessoriabile con kit illuminazione.

Igloo Consolle completes the set of Igloo bar counters. Practical and functional, it consists of two polyethylene units joined by a worktop in white powder coated steel. An optional lighting kit is also available.

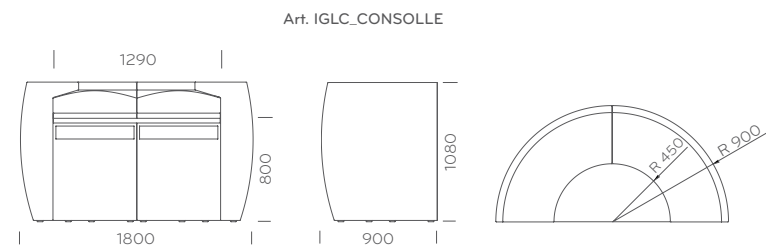

Art. IGLC_CONSOLLE

Art. IGLC_LUCE

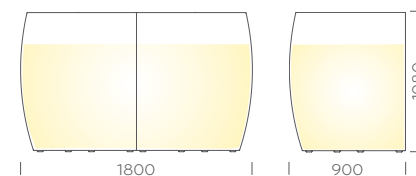

Solo kit illuminazione.
Lighting kit only.



Art. IGL_WORKSTATION

Igloo Workstation è un bancone attrezzato per la preparazione di cocktail. Ideale per l'utilizzo nei locali e per soluzioni catering indoor e outdoor. Il ripiano di lavoro in acciaio inox è dotato di contenitori per ghiaccio e frutta fresca, tagliere in polietilene e vasca di recupero liquidi con kit di scarico. I ripiani inferiori e il portabottiglie sono in acciaio verniciato bianco. Accessoriabile con ripiano superiore in metacrilato bianco e kit di illuminazione.

Igloo Workstation is a bar counter equipped with a cocktail workstation. Ideal for use in clubs and catering solutions. The stainless steel worktop is equipped with trays for ice and fresh fruit, a polyethylene cutting board and a liquid recovery tank with kit for drainage. Lower shelves and the bottleholder are powder coated in white finish. On request, available white methacrylate upper top and lighting kit.

Art. IGL_WORKSTATION

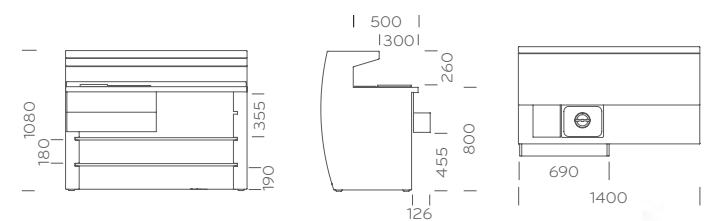

50 Iceberg



Design Claudio Dondoli and Marco Pocci

Art. IBE_BI - IBE_LUCE

Ideale per il bar all'aperto, accanto alla piscina, in spiaggia, in giardino per l'ora dell'aperitivo o dello snack, Iceberg è un banco bar componibile o tavolo alto per buffet. In polietilene ad alta densità bianco opalino, è stampato in rotomoulding. Può essere dotato di impianto interno di illuminazione che lo trasforma in una composizione luminosa e suggestiva.

Ideal for outdoor bar by the pool, at the beach, in the garden for a "happy hour" or a snack, Iceberg is a modular bar counter or a buffet bar table. In high-density roto-moulded polyethylene, white opaline. It can be equipped with internal lighting system.

Art. IBE_BI

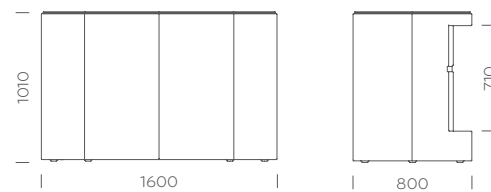

Art. IBE_LUCE

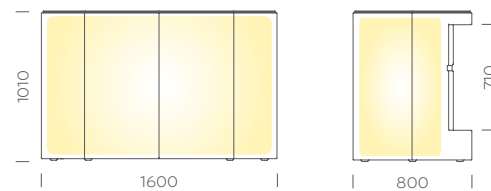

Solo kit illuminazione.
Lighting kit only.

Alcune possibili configurazioni / Some possible combinations

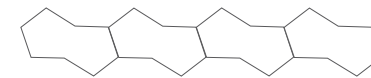

Lineare / Linear

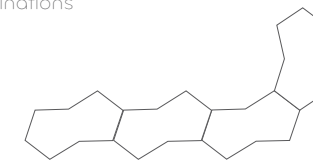

Angolare / Corner

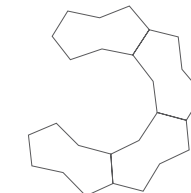

Circolare / Circular

51





Iceberg



Art. IBE_SUP_MET_BI - IBE_INF__BI

I moduli di Iceberg, la cui forma costituisce un doppio pentagono, sono accostabili per comporre infinite forme delle dimensioni desiderate. Facile da spostare e resistente agli urti, Iceberg può avere mensole interne in acciaio verniciato bianco e un top in metacrilato bianco per completare la parte superiore.

The modules of Iceberg, with a double pentagon shape, are built to create endless combinations. Easy to move and shock resistant, Iceberg can have shelves inside in white powder coated steel and a top in white methacrylate to complete the upper surface.

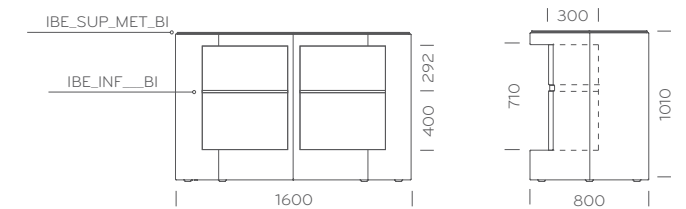



Design Claudio Dondoli and Marco Pucci

Art. TTS_BI - TTS_LUCE - TTS_LED

Tetris è un bancone modulare funzionale a diverse tipologie d'impiego. Facilmente installabile sia in ambienti indoor che outdoor, è resistente agli urti e agli agenti atmosferici.

Realizzato in polietilene bianco, Tetris è accessoriabile con il kit illuminazione che lo rende un bancone scenografico protagonista dell'ambiente.

Tetris modular bar counter for different furnishing needs, easy to install either indoor and outdoor areas. Tetris is shock resistant and weather resistant. Optional lighting kit available for Tetris luminous version. Thanks to neutral colour of the polyethylene it becomes one of the leading elements of the space.

Art. TTS_BI

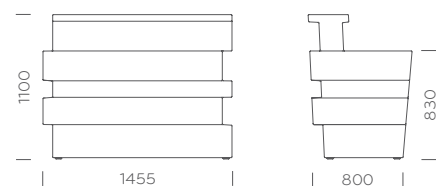

Art. TTS_LED

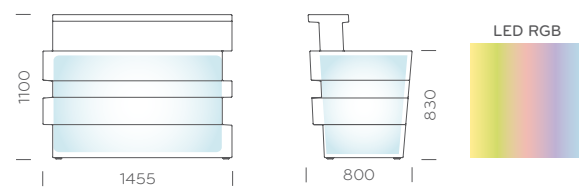

Solo kit illuminazione.
Lighting kit only.

Art. TTS_LUCE

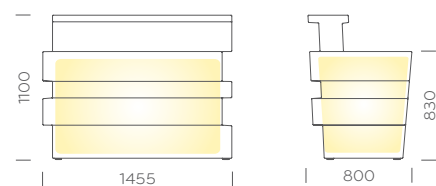

Solo kit illuminazione.
Lighting kit only.



56 Tetris ☁️

Art. TTS_SUP - TTS_RIP - TTS_INF

Tetris può essere accessorizzato con i piani di lavoro e di servizio in acciaio inox satinato o verniciato bianco, resistenti ed igienici, di facile manutenzione. Disponibile a richiesta anche il piano divisorio interno in acciaio inox satinato.

Tetris can be equipped with a working top in brushed or white powder coated stainless steel, resistant, hygienic and easy to clean. On request, also available top for internal division in brushed stainless steel.

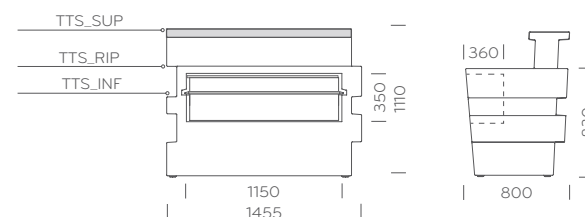



Tetris



Art. TTSA_BI

Eco-friendly, Tetris è 100% riciclabile. Il modulo lineare può essere affiancato ad un modulo angolare. Accessoriabile con kit illuminazione.

Eco-friendly, Tetris is 100% recyclable. The linear unit can be used in combination with a corner unit and equipped with lighting kit.

Art. TTSA_BI

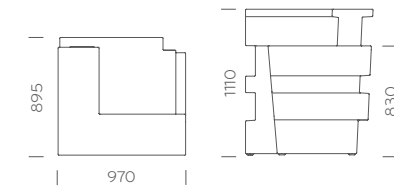

TTS_BI

60 Ypsilon - Ypsilon 4

Design Jorge Pensi Design Studio

Art. 4793 - 4795H_500 - 4797H_500

Tavolo Ypsilon con 3 o 4 razze, base in pressofusione di alluminio e colonna in estruso di alluminio. Versione altezza 500 mm. Finiture disponibili: alluminio lucidato, verniciato o anodizzato (solo per Art. 4793). Piedini in pvc trasparenti. Ypsilon table base, 3 or 4 feet version, cast aluminium base and extruded aluminium column height 500 mm. Finishes: polished, powder coated or anodized aluminium (for Art. 4793 only). Transparent PVC glides.

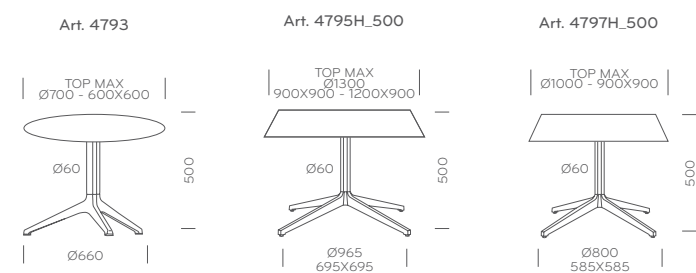

Le altezze dei basamenti indicate non sono comprensive dei ripiani.
Table bases heights do not include table tops.



4793



4795H_500



62 Inox ellittico

Design Pedrali R&D

Art. 4903

Tavolo Inox ellittico con base in acciaio inox satinato e ripiano in stratificato compact full colour bianco.
Elliptical Inox table with brushed stainless steel base and white compact full colour top.

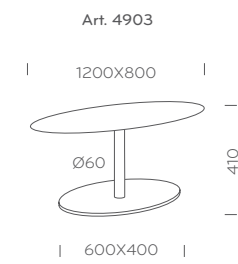

4903/AC



64 Inox

Design Pedrali R&D

Art. 4401 H500 - 4402 H500

Inox tavolino in acciaio inox satinato o lucidato, ripiano in laminato con bordo in ABS spessore 50 mm. Finiture disponibili: avorio, wengé o rovere sbiancato.

Inox low table brushed or polished stainless steel, laminate top with ABS edge thickness 50 mm. Finishes available: ivory, wenge or bleached oak.

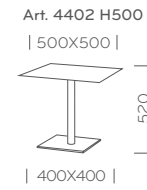
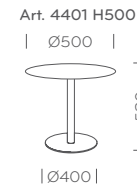

4401 H500



4402 H500

65 Set Pocket

Design Pedrali R&D

Art. SET_POCKET

Set composto da tre tavolini con altezza diversa impilabili uno all'altro. Struttura in tubo d'acciaio satinato 20x20 mm e top in laminato spessore 20 mm disponibile avorio, wengé o rovere sbiancato.

Three low tables set, with different heights, stackable. Satinized steel tube frame 20x20 mm and laminate top thickness 20 mm, available finishes: ivory, wenge or bleached oak.

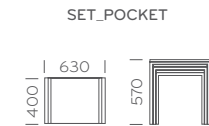
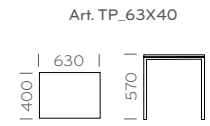
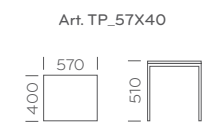
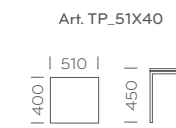

SET_POCKET

66 Inox multifunzionale

Design Pedrali R&D

Art. 4402/ACH_500

Tavolo Inox multifunzionale con basamento in acciaio inox satinato e ripiano multistrato impiallacciato in rovere abbinato a vetro trasparente. Finiture disponibili: wengé, rovere sbiancato o laccato bianco.

Inox multifunctional table, brushed stainless steel base and top with multilayer veneered oak top combined with clear glass. Finishes available: wenge, veneered bleached oak or white lacquered.

Art. 4402/ACH_500

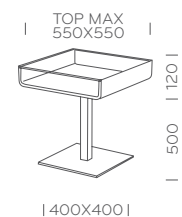

4402/ACH_500

Inox multifunzionale versione altezza 710 mm.
Inox multifunctional version, height 710 mm.



68 Side Table

Design Pedrali R&D

Art. TST_45X45

Tavolino con struttura in tubo d'acciaio satinato e ripiano in laminato spessore 20 mm disponibile nelle finiture wengé, avorio e rovere sbiancato.

Low side table with satinized steel tube frame and laminate top thickness 20 mm; available in wenge, ivory or bleached oak finishes.

Art. TST_45X45

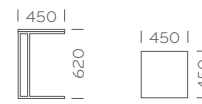

70 Flag

Design Pio e Tito Toso



72 Flag

Art. 5145 - 5144B

Flag è un appendiabiti da terra frutto della sintesi fra forma e funzione, l'unione armonica di elementi che lo rendono apparentemente monomaterico. I bracci in polipropilene si raccordano al tubo portante in acciaio e lo completano in modo organico realizzando la funzione richiesta.

Flag is the perfect synthesis of shape and function. The harmonious combination of different elements makes this coat-hanger mono material looking. The polypropylene arms are inserted into the bearing steel column creating organic lines.

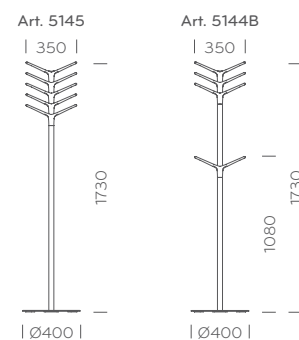

74 Voilà

Design Pedrali R&D

Art. 5130

Appendiabiti Voilà in acciaio inox satinato con terminali in metacrilato trasparente o rosso trasparente.

Voilà coat rack in brushed stainless steel with methacrilate terminals, clear transparent or red transparent colour.

Art. 5130



Wow

Colori Metacrilato | Methacrylate Colours

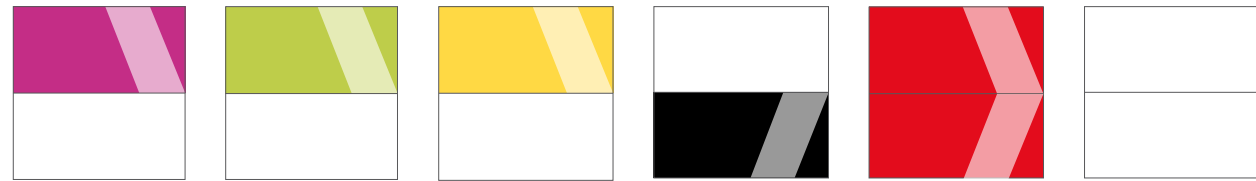

CL.BI / Ciclamino+Bianco
Cyclamen+White

VE.BI / Verde+Bianco
Green+White

GL.BI / Giallo+Bianco
Yellow+White

BL.NE / Bianco+Nero
White+Black

RO / Rosso
Red

OP / Bianco opalino
Opaline white
Solo per l'articolo 486
Only for article 486

Wow

Colori Polietilene | Polyethylene Colours



CI / Ciclamino
Cyclamen

VE / Verde
Green

GI / Giallo
Yellow

NE / Nero
Black

RO / Rosso
Red

BI / Bianco
White

Iceberg - Igloo - Tetris

Colori Polietilene | Polyethylene Colours

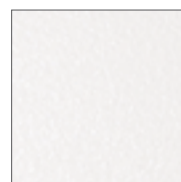

BI / Bianco
White

Kado

Colori Polietilene | Polyethylene Colours



BI / Bianco
White

GA / Grigio antracite
Anthracite grey

BR / Bronzo
Bronze

GC / Grigio chiaro
Light grey

Flag

Colori Polipropilene | Polypropylene Colours



BI / Bianco
White

NE / Nero
Black

BE / Beige
Beige

AR / Arancio
Orange

Finiture metallo | Metal finishes

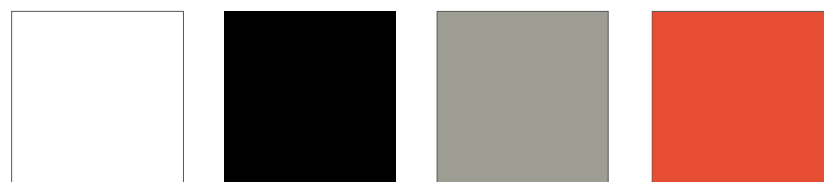

BI / Verniciato bianco
White powder coated

NE / Verniciato nero
Black powder coated

BE / Verniciato beige
Beige powder coated

AR / Verniciato arancio
Orange powder coated

Pouf Pasha

Colori Policarbonato | Polycarbonate Colours



FU / Fumé
Smoky grey

TR / Trasparente
Transparent

BI / Bianco
White

NE / Nero
Black
Solo per utilizzo interno
For indoor use only

Vassoio Pasha

Colori Melamina | Melamine Colours



BI / Bianco
White

NE / Nero
Black
Solo per utilizzo interno
For indoor use only

Ikon (Art. 863V)

Colori Polietilene | Polyethylene Colours



BI / Bianco
White

NE / Nero
Black

Finiture ripiano in vetro | Glass top finishes



BIA / Bianco
White

NER / Nero
Black

Ikon (Art. 863) - Ikon bench

Colori Polipropilene | Polypropylene Colours



BI / Bianco
White

GC / Grigio chiaro
Light grey

BE / Beige
Beige

SA / Sabbia
Sand

NE / Nero
Black
Solo per utilizzo interno
For indoor use only

Finiture ripiano stratificato | Solid laminate top finishes



CFP

COP_263

COP_527

COP_247

COP_NERO
Solo per utilizzo interno
For indoor use only

Brick - Brick4 

Colori Polietilene | Polyethylene Colours



BI / Bianco White
GC / Grigio chiaro Light grey
AR / Arancio Orange
BL / Blu Blue
VE / Verde Green
GI / Giallo Yellow

Malmö

Colori ripiano MDF laccato | MDF laquered top colours



RAL 3018 RAL 1019 RAL 9010

Finitura ripiano stratificato | Solid laminate top finish



CFP COP_NERO

Finiture ripiano impiallacciato frassino | Veneered top finishes



FR / Frassino sbiancato Bleached ash wood
AN / Frassino tinto nero Black stained ash wood

Finiture Telaio | Frame finishes



FR / Frassino sbiancato Bleached ash wood
AN / Frassino tinto nero Black stained ash wood

Parenthesis

Colori ripiano MDF laccato
MDF laquered top colours



GC

Finitura ripiano stratificato
Solid laminate top finish



CFP_BI

Finitura ripiano FENIX NTM®
FENIX NTM® top finish



FNP_NERO

Finiture Telaio | Frame finishes



RS / Rovere sbiancato Bleached oak
AN / Rovere tinto nero Black stained oak
GC / Rovere tinto grigio Grey stained oak
BI / Rovere laccato bianco White laquered oak

Code

Finiture ripiano stratificato | Solid laminate top finishes



NE / Nero Black
BI / Bianco White

Finiture metallo | Metal finishes



NE / Verniciato nero Black powder coated
BI / Verniciato bianco White powder coated

Set Pocket

Finiture ripiano laminato | Laminate top finishes



1813_244 Avorio Ivory
386 Rovere sbiancato Bleached oak
312 Wengè Wengè

Set Pocket white

Finiture ripiano stratificato | Solid laminate top finishes



CFP

Finiture Metallo | Metal Finishes



ST / Acciaio Satinato Satinized Steel

Finiture Metallo | Metal Finishes



BI / Verniciato Bianco White Powder Coated

Side Table

Finiture ripiano laminato | Laminate top finishes



1813_244 Avorio Ivory
386 Rovere sbiancato Bleached oak
312 Wengè Wengè

Side Table white

Finitura ripiano metacrilato | Methacrylate top finish



Bianco White

Finiture Metallo | Metal Finishes



ST / Acciaio Satinato Satinized Steel

Finiture Telaio | Frame finishes

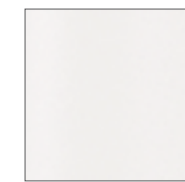

BI / Verniciato Bianco White Powder Coated

Inox

Finiture metallo | Metal finishes



LU / Acciaio inox lucidato
Polished Stainless Steel
Solo per 4401
Only for 4401

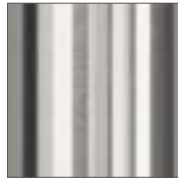

AC / Acciaio inox satinato
Brushed stainless steel

Inox Ellittico | Inox Multifunzionale

Finiture metallo | Metal finishes

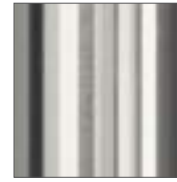

AC / Acciaio inox satinato
Brushed stainless steel

Voilà

Finiture metallo | Metal finishes



AC / Acciaio inox satinato
Brushed stainless steel

Ypsilon - Ypsilon 4

Finiture metallo | Metal finishes



AA / Alluminio anodizzato
Anodized aluminium
Solo per l'articolo 4793
For article 4793 only



LU / Alluminio lucidato
Polished aluminium



ALE / Verniciato alluminio
per esterno
Silver powder coated
for outdoor



NERO / Verniciato nero
Black powder
coated



BIE / Verniciato bianco
per esterno
White powder coated
for outdoor

Pesi, dimensioni e colori sono indicativi. Pedrali si riserva la facoltà di apportare modifiche o migliorie senza alcun preavviso.
Weight, sizes and colours are approximate. Pedrali reserves the right to modify or upgrade the product without prior notice.

Tutte le collezioni Pedrali sono protette nel mondo dal diritto di proprietà industriale e da brevetti registrati.
All Pedrali collections are protected throughout the world by industrial design, patent and copyright registries.

Catalogo Complementi | Edizione Febbraio 2015

Progetto grafico: Borgo Creativo | Photo: Davide Cerati + Studio Odeon + Ottavio Tomasini + Ezio Manciuca + Beppe Brancato |
Credits: Park Hotel Athens + Zazoo Event Rentals | Thanks to: Leftloft | Stampa: Intese Grafiche