

VALEA

seating collection



ICF

Office Furniture Made in Italy

ITALIAN QUALITY IN OFFICE FURNITURE

ICF

Office Furniture Made in Italy

Our chairs have always meant excellence for their aesthetics, functionality, quality of materials, solidity and comfort, and, above all, for the creative and manufacturing processes that are the basis of each collection. That special "Made in Italy" touch has made all our products special for over sixty years, because it is not simply fulfilling a need or providing a solution to a furnishing problem but they represent a real choice of style: ICF style. This is the reason why we are proud of them.

Depuis toujours, nos chaises et fauteuils représentent l'excellence, non seulement en termes d'esthétique, de fonctionnalité, de qualité des matériaux, de solidité et de confort mais également au regard des processus de création et de production à la base de chaque collection. C'est cette touche de Made in Italy qui depuis plus de 60 ans confère à nos produits un caractère unique parce qu'ils ne se limitent pas à répondre à un besoin ni à résoudre un problème d'ameublement, mais il s'agit d'un vrai choix de style : le style ICF. Et nous en sommes fiers.

The VALEA Collection



Comfort generates from elegance: this is the essence of the VALEA collection, a series of different sizes and models of armchairs to satisfy a range of needs.

The collection's distinctive feature is its curved, essential aluminium structure, the base of a completely padded seat covered in fabric or leather to "envelope" the user in comfort. An authentically relaxing chair.



Confort sublimé par l'élégance : telle est l'essence de la collection VALEA, une série de fauteuils déclinés dans différentes dimensions et différents modèles pour répondre aux exigences les plus diverses.

La structure en aluminium, sinieuse et essentielle, est un élément distinctif de la collection sur laquelle repose une assise entièrement rembourré et revêtu de tissu ou de cuir pour « envelopper » de confort qui est assis... une véritable invitation au relax.

Valea Elle

Solidity and expertise meet comfort and aesthetics. This is the beginning of VALEA ELLE, a chair with an essential but captivating line, designed mainly as the executive model of the Collection. In its simplicity, VALEA ELLE lends strength to the room where it is placed because of the details that highlight its line.

La solidité et le prestige mariés au confort et à l'esthétique. C'est ainsi que VALEA ELLE est né, un siège aux lignes essentielles, exclusif dans ses formes et essentiellement pensé comme le modèle de direction de la Collection. Par sa simplicité même, le siège VALEA ELLE parvient à imprimer avec force sa marque à l'espace au sein duquel il s'insère grâce à des détails qui en exalte la ligne.





Shape sublimated from colour

Essential lines are enhanced by a careful choice of colours for the upholstery, to convey warmth and energy to the office environment.

Le dépouillement de la ligne est mis en valeur par une recherche chromatique attentive dans les revêtements pour conférer chaleur et énergie à l'espace de bureau.







Available with high, low-height backrests or headrests, VALEA ELLE transmits an image of authority and pleasant warmth, giving the office environment a distinctive style. Stylistic details such as attention to finishes and variety of colours give the product a strong personality and a modern style.

Disponible avec dossier bas ou, haut et avec appuie-tête, VALEA ELLE transmet dans le même temps une image de prestige et d'agréable chaleur en imprimant un style distinctif à l'espace de bureau. Des détails stylistiques, ainsi le soin accordé aux finitions et la variété des couleurs, lui impriment une personnalité résolument branchée.







Subtle and bold accents in the choice of colour combinations work harmoniously with the simplicity of the shapes.

Des accents plus ou moins audacieux dans le choix des teintes se marient harmonieusement à des formes à l'enseigne de la plus extrême simplicité.







Tilting mechanism. The tilting mechanism, intuitive and effective, follows the user's movements perfectly to guarantee maximum ergonomics.

Armrests. Die-cast aluminium armrests in different finishes, in addition to being comfortable, add character and personality to the chair.

Seams and defined seams. The seam is defined and detailed to emphasise the padded upholstery design, a distinctive element of the collection.

Mécanisme basculant. Le mécanisme basculant, à la fois intuitif et efficace, suit instantanément les mouvements de la personne assise et garantit une ergonomie maximale.

Accoudoirs. Les accoudoirs en aluminium moulé sous pression dans diverses finitions, outre qu'ils sont gage de confort, ajoutent caractère et personnalité au fauteuil.

Coutures et coutures imprimées. Les coutures sont volontairement visibles et particulièrement soignées pour souligner l'épaisseur du rembourrage, élément distinctif de la Collection.

State-of-the-art style and technology

Curved lines are reflected with expertise by the versatility of aluminium, which conveys a sense of strength and lightness at the same time. The broad and extremely comfortable seat is finished with elegance in every detail.

La sinuosité de la ligne est interprétée magistralement par la souplesse de l'aluminium qui imprime vigueur et légèreté à la fois. L'assise, ample et extrêmement confortable, bénéficie de finitions qui incarnent un sens de l'élégance dans les moindres détails.



Extremely versatile aesthetics

VALEA's versatile character is also expressed in its multiple finishes. In leather versions, VALEA manages to maintain the look of the Collection but conveys an image of greater prestige and authoritativeness.

La souplesse de VALEA s'incarne également dans la multiplicité des finitions proposées. Dans la version en cuir, tout en conservant l'empreinte de la Collection, VALEA communique une image de plus grand prestige et d'autorité.





Valea Esse

VALEA ESSE has an even more contoured line that remains essential, modulated to create a lower back support that makes this version even more comfortable. Extreme comfort is guaranteed by the wide seat and its padding.

VALEA ESSE se caractérise par une ligne encore plus sinueuse qui conserve néanmoins son caractère dépouillé, modulée pour créer un soutien lombaire qui accroît plus encore le confort de cette version. L'extrême commodité est garantie par la grande assise et son épais rembourrage.





In any context where it is placed, VALEA ESSE has such a neat line that it adapts harmoniously to the space, while still adding a touch of very personal style.

Quel que soit le contexte dans lequel il s'insère, le fauteuil VALEA ESSE se caractérise par une ligne épurée qui lui permet de s'adapter harmonieusement à l'espace, tout en imprimant dans le même temps une touche de style très personnelle.







In either leather or fabric finish, VALEA ESSE makes colour its main feature - conveying lightness and personality to the office environment.

Que ce soit dans les finitions en cuir ou en tissu, VALEA ESSE met la couleur au premier plan et confère de la sorte brio et personnalité l'espace ce bureau.









Armrests. The shape of the armrests is original, but fluid and in complete harmony with the Valea Collection's underlying concept.

Finishes. Finishes made by precious materials are emphasized by details in the stitching, which becomes a main stylistic element.

Comfort. Technical aspects, such as the tilting mechanism, are indispensable complements for a style in which comfort plays such a big part.

Accoudoirs. La ligne des accoudoirs est originale, à la fois fluide et en totale harmonie: concept de base de la Collection Valea.

Finitions. La très haute qualité des matériaux dans les finitions est exaltée par les détails des coutures qui sont un élément de style à part entière.

Confort. Les solutions techniques, telles que le mécanisme basculant, sont les indispensables compléments d'un style développé à l'enseigne du confort le plus total.

Details of style and technology that make a difference

The style is emphasised even more by the dry essential structure, characterised by elegant, balanced proportions. The thickness of the seat stands out in the overall look of the chair, and strengthens the character of absolute comfort of the VALEA Collection.

Le jeu des lignes est mis en valeur plus encore par l'épure de la structure aux proportions élégantes et équilibrées. L'épaisseur de l'assise est mise en valeur dans le dessin d'ensemble et exalte le caractère de confort absolu de la Collection VALEA.



A close-up photograph of a modern office chair. The chair features a tan leather finish with horizontal stitching on the backrest and seat. The armrest is made of polished chrome metal, curving downwards. The background is plain white.

The leather finish sports unusual colours that soften the shapes of rigorous linearity.

La finition en cuir est enrichie de teintes inédites qui apportent une certaine légèreté à des formes d'une rigoureuse linéarité.

Valea Soft

The perfect blend of aesthetics and comfort of the VALEA Collection finds its highest expression in VALEA SOFT. This model has another detail that ensures comfort: a padded cushion for extra back support.

Le mariage parfait de l'esthétique et du confort que réalise la Collection VALEA trouve son expression la plus accomplie dans VALEA SOFT. Ce modèle s'enrichit en effet d'un détail supplémentaire à l'enseigne de la commodité : un coussin rembourré pour mieux soutenir le dos.





Character in the details

In the SOFT version, VALEA's linearity appears even more accentuated to leave absolute space for comfort: the padded cushion covers the whole seat to make it the perfect place to relax.

Dans la version SOFT, la linéarité de VALEA est encore plus accentuée pour permettre à la commodité de se déployer pleinement : le coussin rembourré couvre toute l'assise et en fait une véritable invitation au relax.









Details. The padding and width of the seat are so characteristic that they make Valea the perfect synonym for comfort and ergonomics, which are conveyed in every stylistic detail.

Contrasts. The flexibility of the armrest line is highlighted by the chrome finish on the aluminium to communicate the idea of dynamic movement and the captivating interplay of contrasts with the softness of the padding.

Exclusiveness. The attention to detail emphasizes the exclusive nature of the covers, whether they are in rigorous leather or more light-hearted fabric.

Détails. Le rembourrage et les grandes dimensions de l'assise sont des éléments d'une telle évidence que Valea est un parfait synonyme de confort et d'ergonomie que chaque détail stylistique exprime.

Contrastes. La souplesse de la ligne des accoudoirs est exaltée par les chromages de l'aluminium et exprime une idée de dynamisme en un jeu subtil de contrastes avec la souplesse des rembourrages.

Exclusivité. Le soin des détails exalte la qualité des revêtements, que ce soit avec la rigueur du cuir ou avec la gaité du tissu.

Technologically comfortable

The padding and width of the seat are so characteristic that they make VALEA the perfect synonym for comfort and ergonomics, which are conveyed in every stylistic detail.

Le rembourrage et les grandes dimensions de l'assise sont des éléments d'une telle évidence que VALEA est un parfait synonyme de confort et d'ergonomie que chaque détail stylistique exprime.



Vitality, comfort, lightness: VALEA SOFT has been invented to offer high level solutions in every detail.

Brio, commodité et légèreté : la chaise VALEA SOFT a été pensée pour offrir des solutions du plus haut niveau dans chaque détail.







Brighter colours match perfectly with the neat lines and innovative interplay of contrasts.

Les teintes les plus vives se marient à la perfection à l'épure de la ligne en un jeu inédit de contrastes.



Valea Cantilever

The unique comfort and aesthetics of VALEA are enhanced by a traditional element: the cantilever base, a classic in the world of office chairs. The result is the new model VALEA CANTILEVER, which reflects the decisive personality of the VALEA collection with new intensity. Hints of classic design blend with functional, modern solutions to form a chair that is not only comfortable, but also particularly versatile and suitable for both operative areas and waiting or meeting rooms.

Le confort et l'esthétique uniques de VALEA s'enrichissent d'un élément de la tradition : la base traîneau, un classique des sièges de bureau. Le résultat est le nouveau modèle VALEA CANTILEVER, qui exalte plus encore la personnalité de la collection VALEA qui semblait pourtant ne pas en avoir besoin. Quelques clins d'œil au design le plus classique se fondent à des solutions fonctionnelles d'une grande actualité, pour un siège non seulement confortable, mais en même temps très flexible puisqu'il s'adapte aux bureaux proprement dits, aux espaces d'attente ou aux salles de réunion.





Lightness and versatility for a classic design

The structure is so light and clean that it seems to float in the air. The cantilever base with its extreme linearity emphasises the shape of the chair and makes it perfect for any place in the room.

Une structure si dépouillée et légère qu'elle semble suspendue dans l'espace. Dans son extrême linéarité, la base traineau exalte la forme de cette chaise et lui permet de trouver place où que ce soit.





Valea Lounge

VALEA LOUNGE was created to perform its function with style and comfort. Destined mainly for waiting rooms or meeting rooms, it keeps all the characteristics of the models with taller backrests and becomes a harmonious addition to any common area. This is the strong point of the VALEA Collection: great versatility that never weakens the line's original personality.

VALEA LOUNGE est né pour déployer style et confort. Essentiellement destiné aux espaces d'attente ou aux salles de réunion, ce fauteuil conserve toutes les caractéristiques des modèles à dossier plus haut et s'intègre avec élégance et harmonie aux espaces sans caractère propre. Telle est la grande force de la Collection VALEA : une grande souplesse qui n'en appauvrit aucunement le caractère d'origine.





Waiting is a pleasure

Essential line and maximum comfort: the chair's wide seat is defined with absolute simplicity and gains impact and personality through its generous padding. Its stylistic details make it the real protagonist of this chair.

Ligne essentielle et confort maximal : le siège, ample et défini par des formes d'une simplicité absolue, acquiert épaisseur et personnalité grâce au riche rembourrage qu'exaltent les détails stylistiques.







Design that invites to relax

Each individual detail of VALEA LOUNGE has been fine-tuned to achieve a unique level of comfort: seat dimensions, choice of padding, and technical aspects all guarantee top-level ergonomics and comfort.

Chacun des moindres détails de VALEA LOUNGE a été pensé pour contribuer au confort unique du fauteuil : des dimensions du fauteuil et du choix du rembourrage aux solutions techniques adoptées gage d'ergonomie maximale et de commodité.



Waiting becomes exciting

In line with the latest fashion trends, the leather and fabric covers of this Collection are available in a wide range of colours: bold, neutral, or delicate palette will warm and brighten the room.

En ligne avec les dernières tendances de la mode, les revêtements de la Collection sont disponibles dans une vaste gamme de couleurs, aussi bien dans la version cuir que dans la version tissu : des teintes plus ou moins vives qui réchauffent et réjouissent l'atmosphère.





TECHNICAL Features



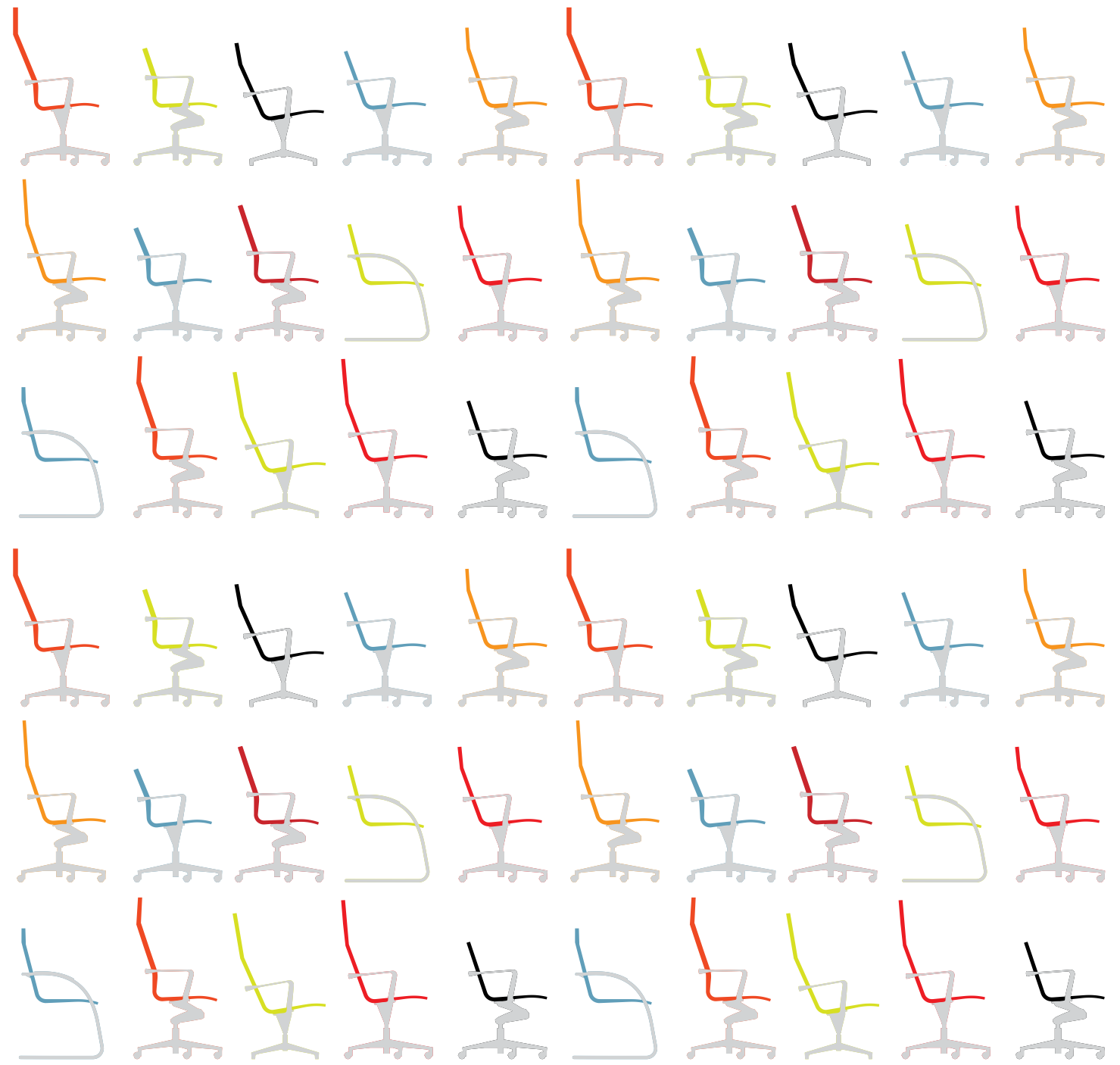

Performing technology

VALEA chairs are designed to provide maximum comfort. Exceptional attention has been paid not only to ergonomic aspects but also to the idea and development of every detail involved in form and function. VALEA chair offers a series of mechanical devices that improve comfort when you are seated even for a significant number of hours. Since the height of the seat can be adjusted as desired, the body assumes the correct position. VALEA chair can be equipped with a mechanism that returns the seat to its original position, so that the office always presents an orderly image.

Tilting Mechanism

Valea Chair has a simple, very effective tilting mechanism that promotes movement and provides a high level of comfort, reducing stress and strains. The rearward seat tilting mechanism pivots from the front of the chair, so that the angle is downward motion, relieving leg stress points and allowing stability in foot positioning on the rearward tilt. The tilting system has an adjustable tension control according to the user's weight and is lockable in various positions.



Base

The 4 and 5 star base are made of die-cast aluminum available in polished and chromed finishing. The ICF custom base design is balanced well with the overall product design and gives particular attention to details.

Padding / fabric or leather

The leather or fabric upholstery is welded onto flexible polyurethane. The sheet thus obtained has a series of typical horizontal stripes and fits to perfectly distribute the weight of the body.

Armrests

They have a closed shape and are made of die cast aluminum available in polished or chromed finishing.

Auto-return mechanism

The 4 star base has a special column that allows free-swiveling in use and that automatically rotates backrest to a frontward facing position. The fixed height column helps to keep your meeting room always in an ordinate manner.



Castors

Standard: body made of reinforced copolymer with chromed die-cast, zamak hood; twin-wheels reinforced copolymer soft treads, suitable for all floors.

Glides

Standard black nylon base, white soft central elements, suitable for all floors.

Height adjustment

The 5 star base model has a height adjustment column that allows to adjust the chair individually according to different heights of users and sitting habits. The heights adjustment column allows height regulation in any position along the total stroke through internal movement of gas. It is controlled by pulling up a simple, well visible and intuitive lever.

Configurations

VALEA offers the widest range of choice and is available in three backrest heights. Options are autoreturn mechanism, height adjustment and tilting mechanism with enhanced forward rotation.

There are two different bases: 4 star base on glides or 5 star base on castors.

There are also versions with "ELLE" and "ESSE" back and "LOUNGE" with a wider seat.

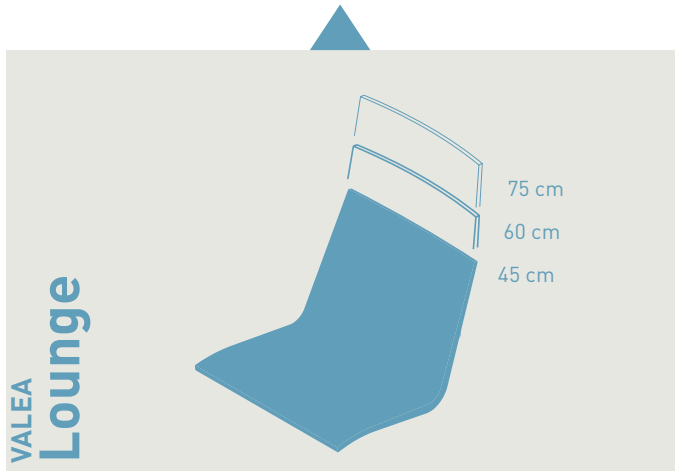
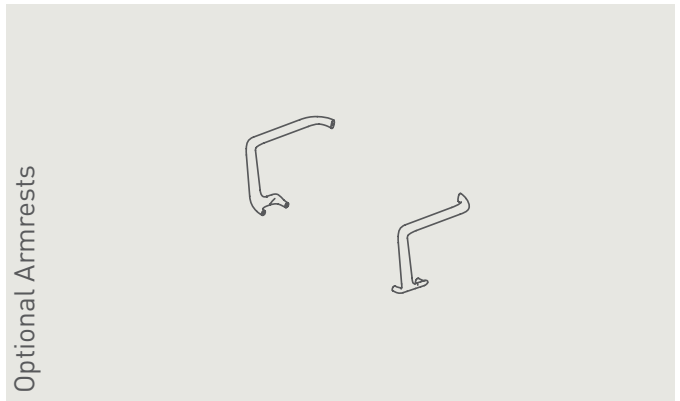

Optional Armrests

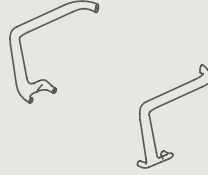

VALEA
Elle

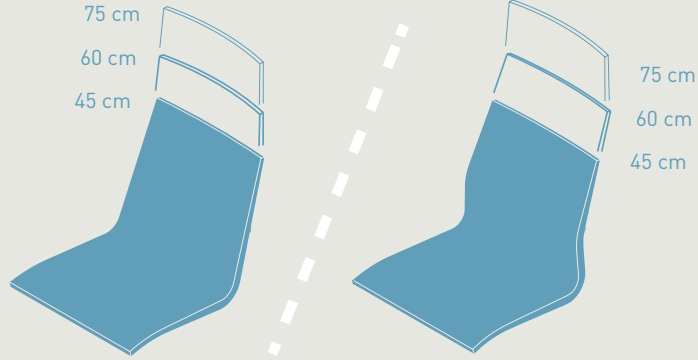

VALEA
Esse

Fixed Height
Support



Adjustable Height
Support

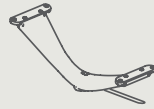

Tilting
Support

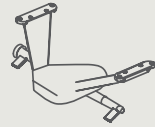

4 star base

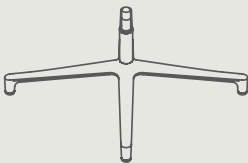

5 star base on castors

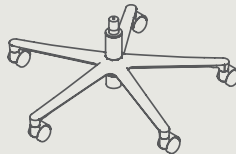

5 star base on castors

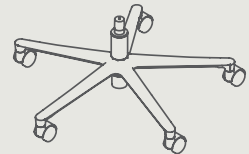

Finishings



At ICF we have very carefully selected the best fabrics, the most resistant techno materials and the most valuable leather, which make up the integral and weight bearing part of our chair's structure. We offer different finishes that are always updated according to the latest trends and give a touch of colour and originality to the environment where they are placed.

CAT B Atlantic

CAT C Fame
Step
Step Melange
Sotega

CAT F Breeze
Fame Hybrid

CAT E Leather

CAT H (only Soft) Premium Leather

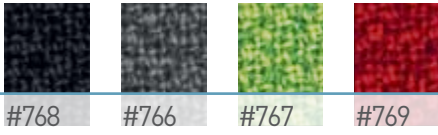
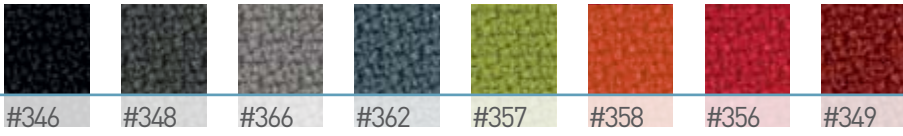
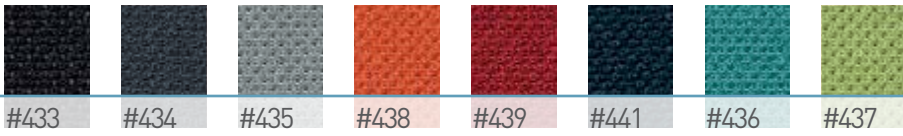

Surfaces & Metals

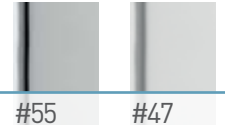

Dimensions

Fixed Height Support

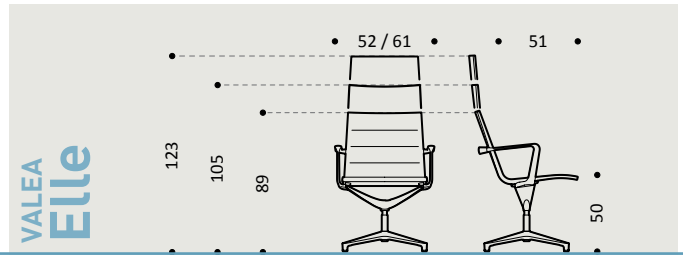

Adjustable Height Support

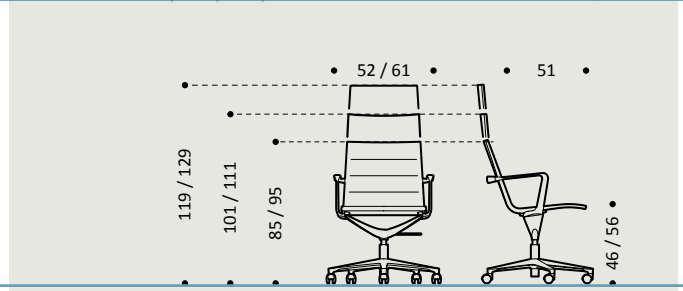

Tilting Support

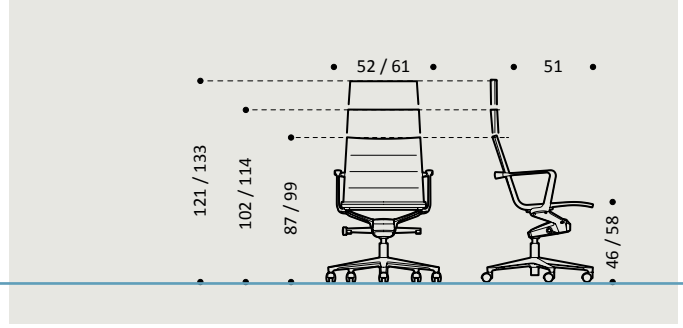

To meet the demands of an increasingly competitive market, we submit our products to rigorous tests that certify dimension, safety, solidity and resistance that define internationally accepted comfort and quality standards.

Fixed Height Support

Cantilever Support

VALEA
Esse

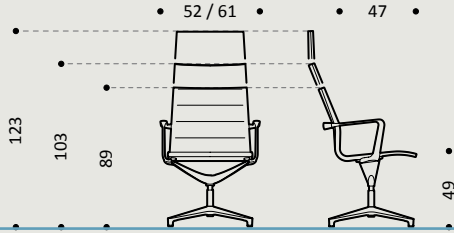

VALEA
Soft

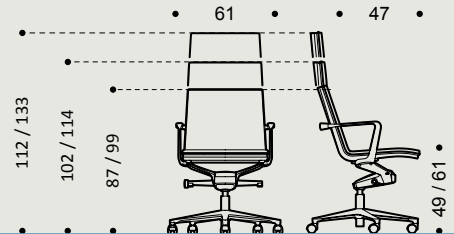
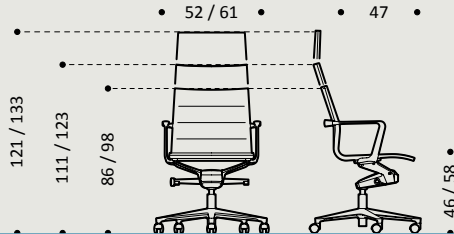
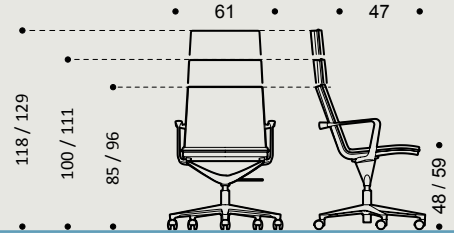
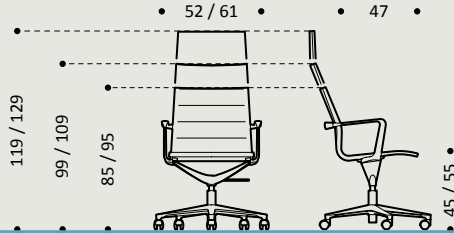
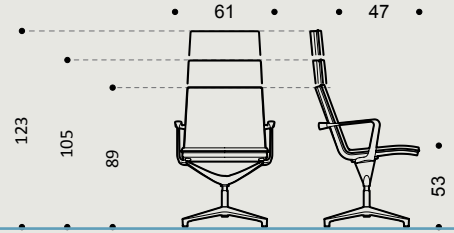

VALEA
Lounge

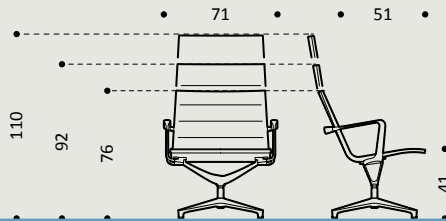

VALEA
Lounge
Soft

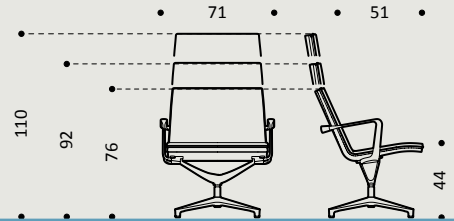

VALEA
Cantilever

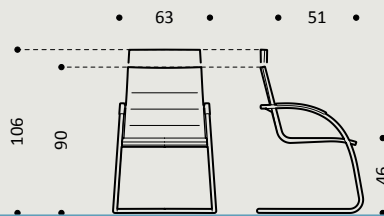

VALEA
Cantilever
Soft

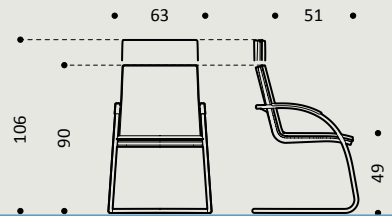



ICF S.p.A.
Via Cassanese, 108
20060 Vignate (MI), Italy
t. +39 02 9508031 f. +39 02 95364012
icf@icf-office.it www.icf-office.it

