

vanEsch

LOCKERS  
SCHRANKEN  
ARMOIRES

vanEsch

**LÖCKERS**  
**SCHRANKE**  
**ARMOIRES**

# INHOUD INDEX INHALT CONTENT

AQUARIUS H 05

AQUARIUS S 33

REFERENCE RIJKSMUSEUM 57

REFERENCE BERNHOVEN 63

REFERENCE BUREAU JEUGDZORG 67

REFERENCE INDICIA 73

REFERENCE RABOBANK 75

REFERENCE EUROMEX 83

REFERENCE LIST 87

vanEsch  
**AQUARIUS H**  
design van Esch Team, The Netherlands



## AQUARIUS H

Grote kasten, kleine kastjes, postvakken naast elkaar of boven elkaar. De lockers uit het programma Aquarius zijn door de vele mogelijkheden vooral functioneel.

De strak vormgegeven romp is uitgevoerd in wit. De deuren zijn standaard verkrijgbaar in wit, zwart, licht- of middelgrijs. Deuren en zijpanelen zijn tegen een meerprijs leverbaar in circa 150 verschillende kleuren of houtdecors. De kasten zijn voorzien van een zwarte metalen plint met stelvoeten.

Large lockers, small cabinets, pigeon holes, alongside or one above the other. The lockers from the Aquarius series are thanks to the many possibilities they offer highly functional. The sleek body is finished in white. The doors are available as standard in white, black, light grey and medium grey. Doors and side panels are available for a supplement in approximately 150 different colours and wood effects. The models come with black metal plinths and adjustable feet.

Große Schränke, kleine Schränke, Postfächer neben- oder übereinander. Die Schränke aus dem Programm Aquarius sind verfügen über zahlreiche funktionelle Gestaltungsmöglichkeiten. Den geradlinig gestalteten Korpus gibt es in Weiß. Die Türen sind serienmäßig in Weiß, Schwarz und in Hell- oder Mittelgrau erhältlich. Türen und Seitenteile sind gegen Aufpreis in etwa 150 verschiedenen Farben oder Holzoptiken erhältlich. Die Schränke sind mit einer schwarzen Sockel aus Metall und Stellfüßen versehen.

Grandes armoires, petites armoires, boîtes aux lettres juxtaposées ou superposées. Les casiers de la gamme Aquarius sont surtout fonctionnels par leurs nombreuses possibilités d'utilisation.

Le corps au design sobre est réalisé en blanc. Les portes sont disponibles de façon standard en blanc, en noir ou en gris clair ou moyen. Contre un supplément de prix, les portes et les panneaux latéraux de finition sont disponibles dans environ 150 couleurs ou décors bois différents. Les armoires sont pourvues d'une plinthe métallique noire avec pieds réglables.





111



115



118



122



126



130



134



138



142



146



116



119



123



127



131



135



139



143



147



120



124



128



132



136



140



144



112



121



125



129



133



137



141



145















## AQUARIUS HG

HG2302/P  
HG2402/P

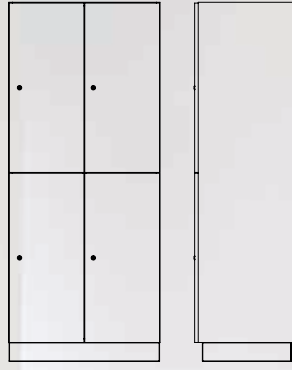

190 cm  
74,8 inch

60 / 80 cm  
23,6 / 31,5 inch

52 cm  
20,5 inch



## AQUARIUS HG

HG2301/P  
HG2401/P

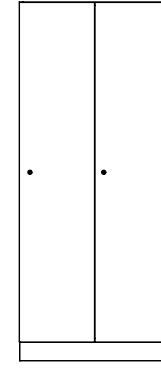

60 / 80 cm  
23,6 / 31,5 inch

HG2302/P  
HG2402/P

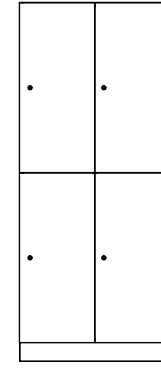

60 / 80 cm  
23,6 / 31,5 inch

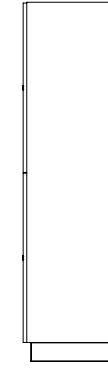

190 cm  
74,8 inch

52 cm  
20,5 inch

HG1301/P  
HG1401/P

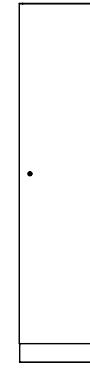

30 / 40 cm  
11,8 / 15,7 inch

HG1302/P  
HG1402/P



30 / 40 cm  
11,8 / 15,7 inch

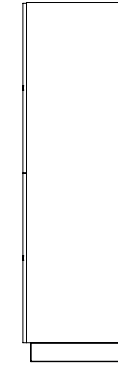

190 cm  
74,8 inch

52 cm  
20,5 inch

## AQUARIUS HV

HV2304/P  
HV2404/P

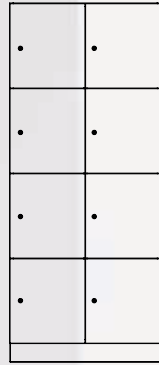

60 / 80 cm  
23,6 / 31,5 inch

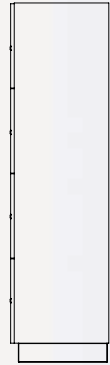

52 cm  
20,5 inch

190 cm  
74,8 inch



See reference pages 63 and 83

## AQUARIUS HV

HV2303/P  
HV2403/P

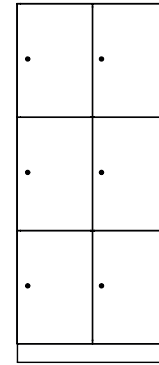

60 / 80 cm  
23,6 / 31,5 inch

HV2304/P  
HV2404/P

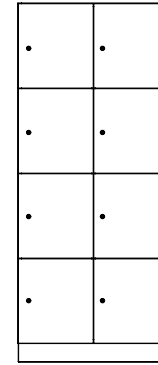

60 / 80 cm  
23,6 / 31,5 inch

HV2305/P  
HV2405/P

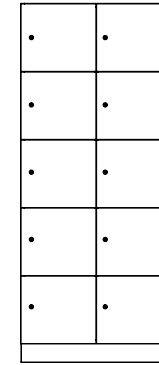

60 / 80 cm  
23,6 / 31,5 inch

HV2306/P  
HV2406/P

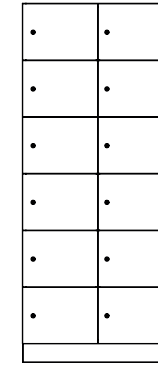

60 / 80 cm  
23,6 / 31,5 inch

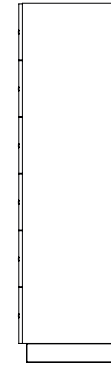

52 cm  
20,5 inch

190 cm  
74,8 inch

HV1303/P  
HV1403/P

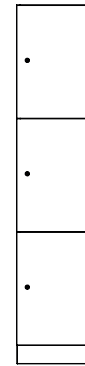

30 / 40 cm  
11,8 / 15,7 inch

HV1304/P  
HV1404/P

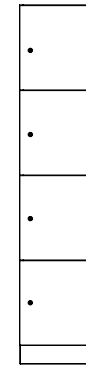

30 / 40 cm  
11,8 / 15,7 inch

HV1305/P  
HV1405/P

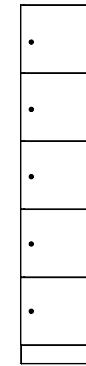

30 / 40 cm  
11,8 / 15,7 inch

HV1306/P  
HV1406/P

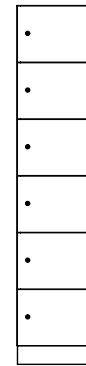

30 / 40 cm  
11,8 / 15,7 inch

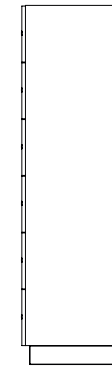

52 cm  
20,5 inch

190 cm  
74,8 inch

## AQUARIUS HF

HF2403/P

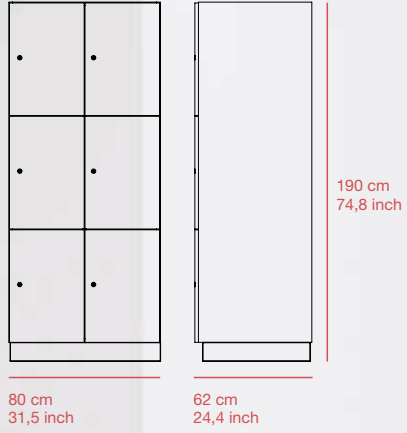

## AQUARIUS HF

HF2403/P

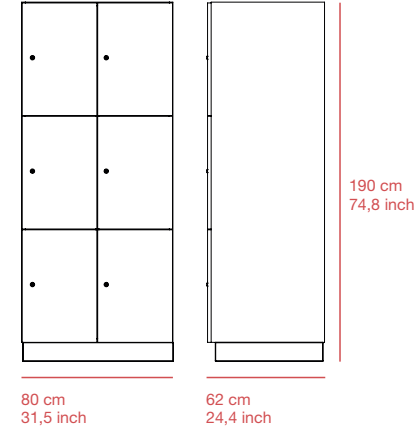

HF1403/P

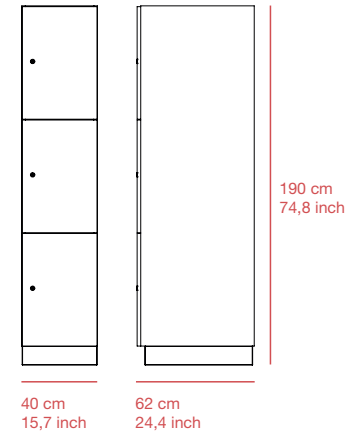



## AQUARIUS HVL

HVL2302/P  
HVL2402/P

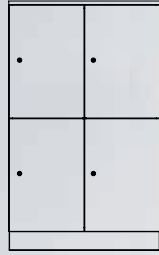

60 / 80 cm  
23,6 / 31,5 inch



52 cm  
20,5 inch

132 cm  
52,0 inch



## AQUARIUS HVL

HVL2302/P  
HVL2402/P

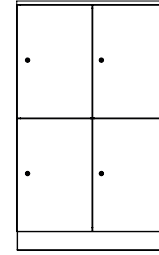

60 / 80 cm  
23,6 / 31,5 inch

HVL2303/P  
HVL2403/P

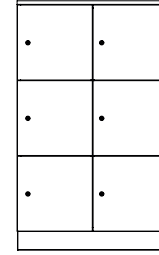

60 / 80 cm  
23,6 / 31,5 inch

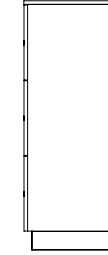

52 cm  
20,5 inch

132 cm  
52,0 inch

HVL1302/P  
HVL1402/P



30 / 40 cm  
11,8 / 15,7 inch

HVL1303/P  
HVL1403/P

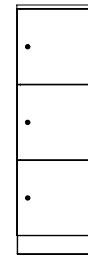

30 / 40 cm  
11,8 / 15,7 inch

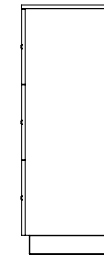

52 cm  
20,5 inch

132 cm  
52,0 inch

See reference page 67

# AQUARIUS HP

HP1306

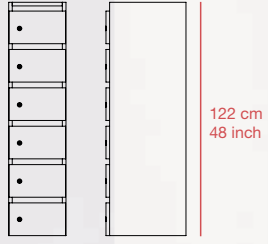

30 cm  
11,8 inch

42 cm  
16,5 inch



# AQUARIUS HP

HP1304

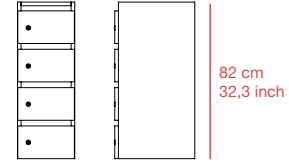

30 cm  
11,8 inch

42 cm  
16,5 inch

HP1305

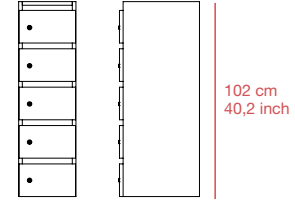

30 cm  
11,8 inch

42 cm  
16,5 inch

HP1306

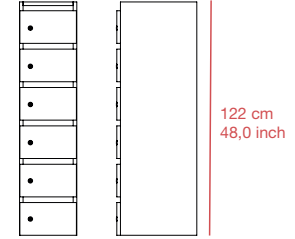

30 cm  
11,8 inch

42 cm  
16,5 inch

## AQUARIUS H ACCESSORIES



H/CS cylinder lock



H/MS coin lock



H/PCS LS100 pin code lock



H/PCS Mauer pin code lock



NP number tag



NH1 name plate holder



NH2 name plate holder



NH3 name plate holder



NH4 number tag



NH4 number tag



NH5 card holder



SN key number tag



H/PN number tag

## STANDAARD KLEUREN COLORIS STANDARD

### Kleurcode S

romp wit, deuren en kantband wit (97/85), lichtgrijs (97/74), middelgrijs (97/75) of zwart (02/007)

Kleuren: [www.van-esch.com](http://www.van-esch.com)

### Colourcode S

body white, doors and edging in white (97/85), silvergrey 97/74, medium grey (97/75) or black (02/007)

Colours: [www.van-esch.com](http://www.van-esch.com)

### Farbkode S

Korpus weiß, Türe und gleichfarbiger Kanten weiß (97/85), silbergrau 97/74, mittelgrau (97/75) oder schwarz (02/007)

Farben: [www.van-esch.com](http://www.van-esch.com)

### Code coloris S

corps blanc, portes et bande de chant dans la même finition, blanc (97/85), gris argenté 97/74, mi-gris (97/75) ou noir (02/007)

Couleurs: [www.van-esch.com](http://www.van-esch.com)

## STANDARD COLOURS STANDARDFARBEN

### Body



97/85

### Doors + Panels



97/85



97/74



97/75



02/007

# UNIKLEUREN UNI-COLOURS UNI FARBEN COLORIS UNI

## Kleurcode U

romp wit; deuren in een Pfeiderer  
Uni Kleur inclusief kantband in dezelfde  
kleur. (ca. 80 varianten)

Kleuren: [www.van-esch.com](http://www.van-esch.com)

## Colourcode U

body white; doors in a Pfeiderer  
Uni-colour including edging in the  
same colour. (approx. 80 finishes)

Colours: [www.van-esch.com](http://www.van-esch.com)

## Farbkode U

Korpus weiß; Türen in eine Pfeiderer  
Uni-Farbe einschließlich gleichfarbiger  
Kanten. (ungefähr 80 Varianten)

Farben: [www.van-esch.com](http://www.van-esch.com)

## Code coloris U

corps blanc; portes en une Pfeiderer  
Coloris Uni y-compris bande de chant  
dans la même finition. (environ 80  
finitions)

Couleurs: [www.van-esch.com](http://www.van-esch.com)

## Body



97/85

## Doors + Panels



SE2 Sneeuw wit Str. MP	U1027 Ijswit Str. VV	U102 Krijt wit Str. VV	SR209 Edelwit Str. VV
------------------------------	----------------------------	------------------------------	-----------------------------



U130 Beige Str. MP	U1010 Wit/grijs Str. MP	U035 Parelgrijs Str. MP	U1131 Zilvergrijs Str. MP
--------------------------	-------------------------------	-------------------------------	---------------------------------



U1806 Dennengroen Str. MP	U110 Iguana Str. MP	U194 Zinkgeel Str. MP	U1559 Pastelgeel Str. MP
---------------------------------	---------------------------	-----------------------------	--------------------------------



U1508 Milano geel Str. VV	U032 Oranje Str. MP	U1667 Oranje Str. MP	U1665 Sinaasappel Str. VV
---------------------------------	---------------------------	----------------------------	---------------------------------



U1691 Robijnrood Str. VV	U225 Signaalrood Str. MP	U230 Licht Vanille Str. MP	U1379 Magnoliawit Str. MP
--------------------------------	--------------------------------	----------------------------------	---------------------------------



U133 Kieselgrijs Str. MP	U087 Magma Str. MP	U1184 Zandgrijs Str. MP	U1191 Congo Str. VV
--------------------------------	--------------------------	-------------------------------	---------------------------



U179 Cuba libre Str. VV	U182 Donkerbruin Str. MP	U1102 Truffelgrijs Str. VV	U092 Zonda grijs Str. MP
-------------------------------	--------------------------------	----------------------------------	--------------------------------



U018 Basaltgrijs Str. MP	U1257 Grafietgrijs Str. MP	U506 Antraciet metallic Str. MP	F8595 Grijs antraciet Str. MP
--------------------------------	----------------------------------	---------------------------------------	-------------------------------------



U074 Atlantic Str. MP	U079 Pacific Str. MP	U1739 Kristalblauw Str. MP	U1747 Donkerblauw Str. MP
-----------------------------	----------------------------	----------------------------------	---------------------------------



U057 Marineblauw Str. MP	U141 Orchidee Str. MP	U1200 Vulkaanzwart Str. MP/VV	U007 Grafietzwart Str. MP
--------------------------------	-----------------------------	-------------------------------------	---------------------------------



U501 Champagne metallic Str. MP	W410 Dekkend wit Str. MP	Span 140 Industrie wit Str. MP/SM	U1011 Vulkaanwit Str. MP	U197 Ivoor Str. MP
---------------------------------------	--------------------------------	---	--------------------------------	--------------------------



U1188 Lichtgrijs Str. MP	U1179 Manhattan grijs Str. MP	SR 204 Manhattan grijs Str. MP	U107 Avocado Str. MP	U1365 Camee Str. MP
--------------------------------	-------------------------------------	--------------------------------------	----------------------------	---------------------------



U116 Vanille Str. MP	U115 Bremgeel Str. MP	U1579 Eigeel Str. MP	U1574 Fluweelgeel Str. MP	U192 Zonnebloemgeel Str. MP
----------------------------	-----------------------------	----------------------------	---------------------------------	-----------------------------------



U246 Mango Str. MP	U054 Bourgondisch rood Str. MP	U031 Bordeaux Str. MP	U027 Wijnrood Str. MP
--------------------------	--------------------------------------	-----------------------------	-----------------------------

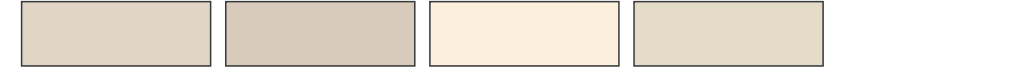

U184 Crème Str. MP	U1343 Zand Str. VV	U1303 Ivoorwit Str. VV	U1331 Beige/grijs Str. MP
--------------------------	--------------------------	------------------------------	---------------------------------



U1193 Quando Str. VV	U089 Fango Str. MP	U1980 Terrabruin Str. MP	U1349 Caramel Str. MP
----------------------------	--------------------------	--------------------------------	-----------------------------



U1211 Lava Str. MP	U1983 Coco Str. VV	U090 Bora grijs Str. MP	U091 Sharki Str. MP
--------------------------	--------------------------	-------------------------------	---------------------------



U1115 Platinagrijs Str. MP	U010 Platinagrijs Str. MP	U508 Grijs metallic Str. MP	F8582 Wit aluminium Str. MP	MP MiniPerl
----------------------------------	---------------------------------	-----------------------------------	-----------------------------------	----------------



U059 Gentiaanblauw Str. MP	U068 Hemelsblauw Str. MP	U1715 Hemelsblauw Str. MP	U056 Royal blue Str. MP	VV Top Velvet
----------------------------------	--------------------------------	---------------------------------	-------------------------------	------------------



U011 Vulkaan grijs Str. MP	U1233 Metaalzwart Str. MP	U231 Leisteengrijs Str. MP	U1290 Antracietgrijs Str. MP	SM Zijdemat/Satin
----------------------------------	---------------------------------	----------------------------------	------------------------------------	----------------------

## Textures



# HOUT DECORS WOOD DECORS HOLZDEKORE DÉCORS BOIS

## Kleurcode HD

romp wit, deuren in een Pfeleiderer  
Hout Decors inclusief kantband in  
dezelfde kleur. (ca. 80 varianten)  
Kleuren: [www.van-esch.com](http://www.van-esch.com)

## Colourcode HD

body white; doors in a Pfeleiderer Wood  
Decor including edging in the same  
colour. (approx. 80 finishes)  
Colours: [www.van-esch.com](http://www.van-esch.com)

## Farbkode HD

Korpus weiß; Türen in eine Pfeleiderer  
Holz Dekor einschließlich gleichfarbiger  
Kanten. (ungefähr 80 Varianten)  
Farben: [www.van-esch.com](http://www.van-esch.com)

## Code coloris HD

corps blanc; portes en une Pfeleiderer  
Décor Bois y-compris bande de chant  
dans la même finition. (environ 80  
finitions)  
Couleurs: [www.van-esch.com](http://www.van-esch.com)

## Body



97/85

## Doors + Panels



## Textures

vanEsch  
**AQUARIUS S**  
design van Esch Team, The Netherlands



## AQUARIUS S

Bij de metalen Aquarius kasten ligt de nadruk op functie. Onnodige franjes ontbreken. Evengoed is het programma veelzijdig. De kasten zijn leverbaar met plint, onderstel of in combinatie met een zitbank, als garderobekast, maar ook als postvak. En met of zonder slot. Het uitgebreide programma is verkrijgbaar in ruim twintig standaard RAL-kleuren.

With the metal Aquarius the emphasis is on function. The versatility of the programme lies in its simplicity. The lockers are available with plinth, on a frame or in combination with a bench, as a wardrobe but also as a pigeon hole. And with or without a lock. The comprehensive series is available in over twenty standard RAL colours.

Bei den Metallschränken der Reihe Aquarius liegt der Akzent auf der Funktion. Kein überflüssiger Schnickschnack. Dafür ein ausgesprochen vielseitiges Programm. Die Schränke sind mit Sockel, Untergestell oder in Verbindung mit einer Sitzbank, als Garderobenschrank, oder auch als Postfach-Variante lieferbar mit oder ohne Schloss. Das breit gefächerte Programm ist in gut zwanzig RAL-Farben erhältlich.

Avec les armoires métalliques Aquarius, l'accent est mis sur la fonctionnalité, sans apprêt. Ce programme est aussi très varié. Les armoires sont disponibles avec plinthe, piétement ou en combinaison avec un banc, comme armoire de vestiaire, mais aussi comme casier de courrier, avec ou sans serrure. Cette large gamme est disponible dans plus de vingt couleurs standard RAL.













# AQUARIUS SG

SG2301/P  
SG2401/P  
SG2501/P

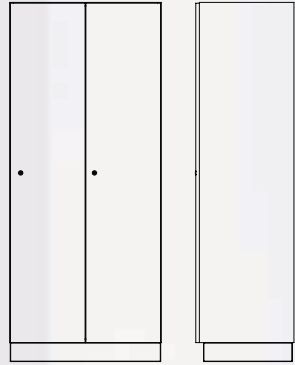

60 / 80 / 100 cm  
23,6 / 31,5 / 39,4 inch

50 cm  
19,7 inch

185 cm  
72,8 inch



See reference pages 57 and 75

# AQUARIUS SG

SG1301/P  
SG1401/P  
SG1501/P

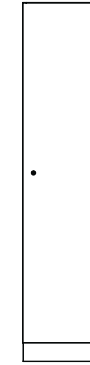

30 / 40 / 50 cm  
11,8 / 15,7 / 19,7 inch

SG2301/P  
SG2401/P  
SG2501/P

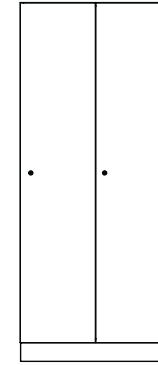

60 / 80 / 100 cm  
23,6 / 31,5 / 39,4 inch

SG3301/P  
SG3401/P

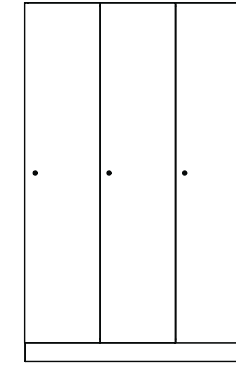

90 / 120 cm  
35,4 / 47,2 inch

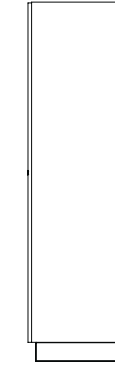

50 cm  
19,7 inch

185 cm  
72,8 inch

SG1301/O  
SG1401/O  
SG1501/O

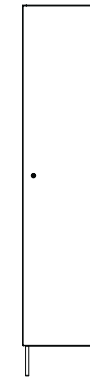

30 / 40 / 50 cm  
11,8 / 15,7 / 19,7 inch

SG2301/O  
SG2401/O  
SG2501/O

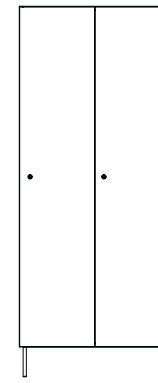

60 / 80 / 100 cm  
23,6 / 31,5 / 39,4 inch

SG3301/O  
SG3401/O

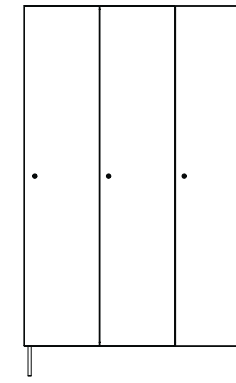

90 / 120 cm  
35,4 / 47,2 inch

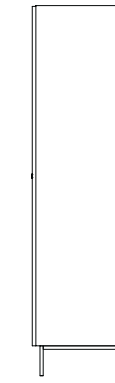

50 cm  
19,7 inch

200 cm  
78,7 inch

SG1301/OB  
SG1401/OB  
SG1501/OB



30 / 40 / 50 cm  
11,8 / 15,7 / 19,7 inch

SG2301/OB  
SG2401/OB  
SG2501/OB

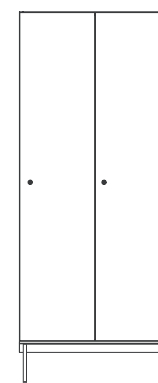

60 / 80 / 100 cm  
23,6 / 31,5 / 39,4 inch

SG3301/OB  
SG3401/OB

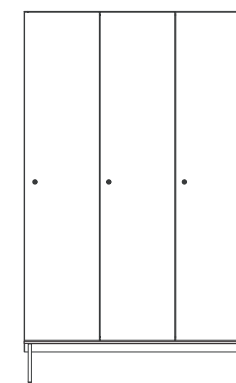

90 / 120 cm  
35,4 / 47,2 inch

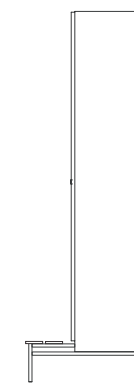

80 cm  
31,5 inch

200 cm  
78,7 inch

# AQUARIUS SG

SG1302/P  
SG1402/P

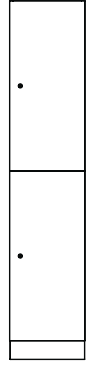

30 / 40 cm  
11,8 / 15,7 inch

SG2302/P  
SG2402/P

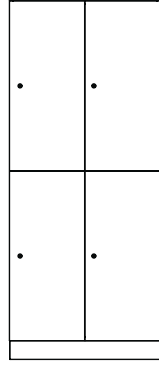

60 / 80 cm  
23,6 / 31,5 inch

SG3302/P  
SG3402/P

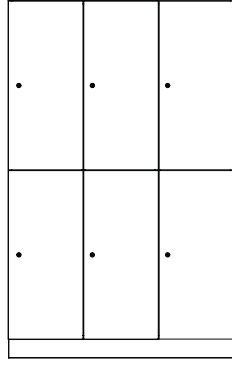

90 / 120 cm  
35,4 / 47,2 inch

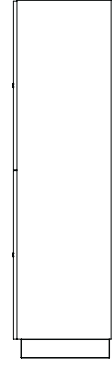

50 cm  
19,7 inch

185 cm  
72,8 inch

SG1302/O  
SG1402/O

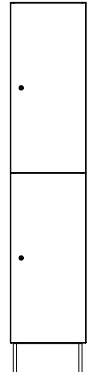

30 / 40 cm  
11,8 / 15,7 inch

SG2302/O  
SG2402/O

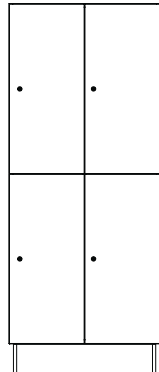

60 / 80 cm  
23,6 / 31,5 inch

SG3302/O  
SG3402/O

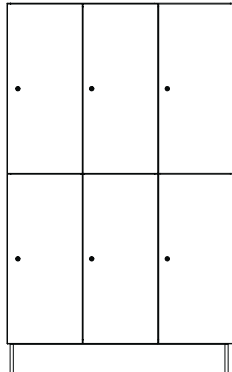

90 / 120 cm  
35,4 / 47,2 inch

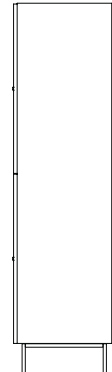

50 cm  
19,7 inch

200 cm  
78,7 inch

SG1302/OB  
SG1402/OB

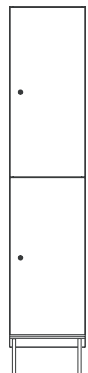

30 / 40 cm  
11,8 / 15,7 inch

SG2302/OB  
SG2402/OB

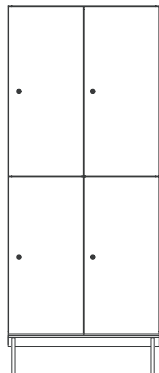

60 / 80 cm  
23,6 / 31,5 inch

SG3302/OB  
SG3402/OB

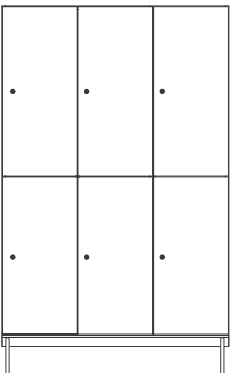

90 / 120 cm  
35,4 / 47,2 inch

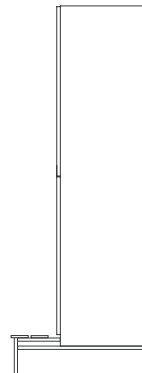

80 cm  
31,5 inch

200 cm  
78,7 inch



# AQUARIUS SZ

SZ3402/P

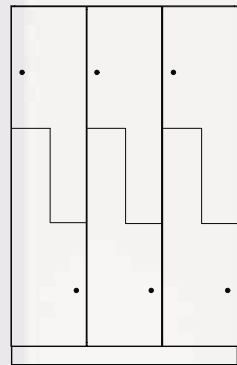

185 cm  
72,8 inch

120 cm  
47,2 inch



185 cm  
72,8 inch

50 cm  
19,7 inch



# AQUARIUS SZ

SZ1402/P  
SZ1502/P

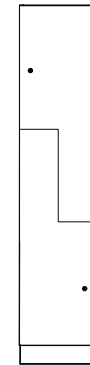

40 / 50 cm  
15,7 / 19,7 inch

SZ2402/P  
SZ2502/P

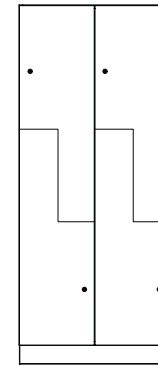

80 / 100 cm  
31,5 / 39,4 inch

SZ3402/P

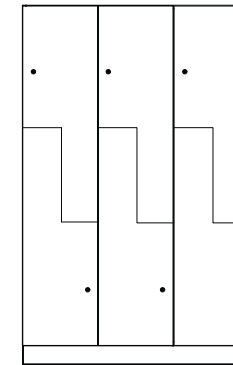

120 cm  
47,2 inch

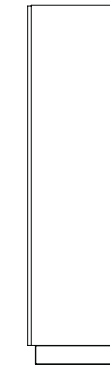

185 cm  
72,8 inch

50 cm  
19,7 inch

SZ1402/O  
SZ1502/O

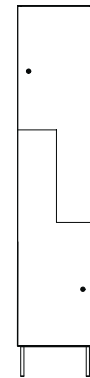

40 / 50 cm  
15,7 / 19,7 inch

SZ2402/O  
SZ2502/O

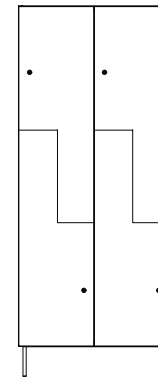

80 / 100 cm  
31,5 / 39,4 inch

SZ3402/O

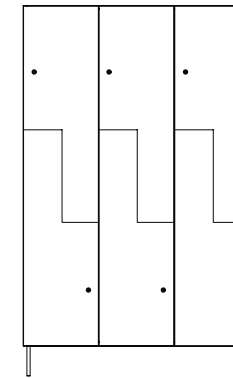

120 cm  
47,2 inch

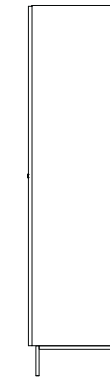

200 cm  
78,7 inch

50 cm  
19,7 inch

SZ1402/OB  
SZ1502/OB

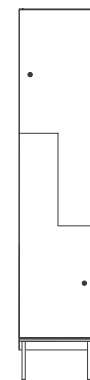

40 / 50 cm  
15,7 / 19,7 inch

SZ2402/OB  
SZ2502/OB

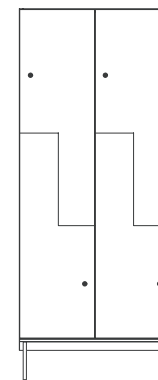

80 / 100 cm  
31,5 / 39,4 inch

SZ3402/OB

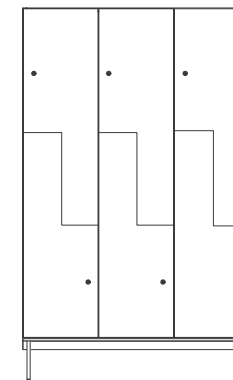

120 cm  
147,2 inch

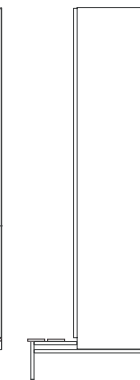

200 cm  
78,7 inch

80 cm  
31,5 inch

# AQUARIUS SV

SV1305/P  
SV1405/P

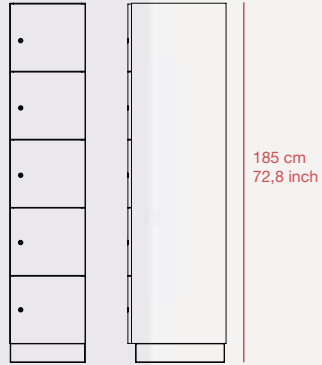

30 / 40 cm 50 cm  
11,8 / 15,7 inch 19,7 inch



# AQUARIUS SV

SV1303/P SV1304/P SV1305/P  
SV1403/P SV1404/P SV1405/P

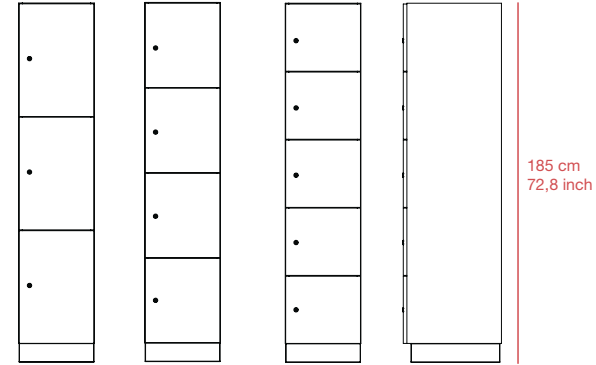

30 / 40 cm 30 / 40 cm 30 / 40 cm 50 cm  
11,8 / 15,7 inch 11,8 / 15,7 inch 11,8 / 15,7 inch 19,7 inch

SV2303/P SV2304/P SV2305/P  
SV2403/P SV2404/P SV2405/P

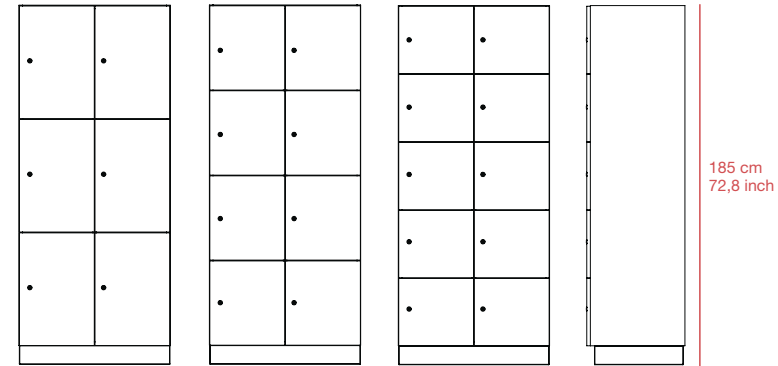

60 / 80 cm 60 / 80 cm 60 / 80 cm 50 cm  
23,6 / 31,5 inch 23,6 / 31,5 inch 23,6 / 31,5 inch 19,7 inch

SV3303/P SV3304/P  
SV3403/P SV3404/P

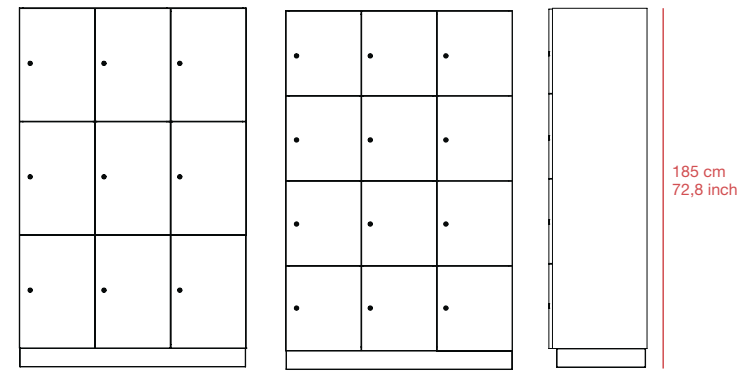

90 / 120 cm 90 / 120 cm 50 cm  
35,4 / 47,2 inch 35,4 / 47,2 inch 19,7 inch

# AQUARIUS SP

SP1306

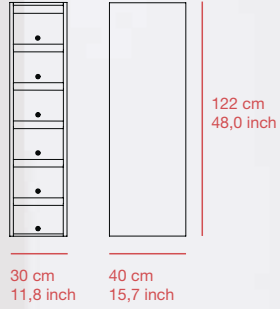

# AQUARIUS SP

SP1305

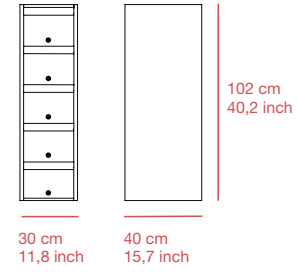

SP1306

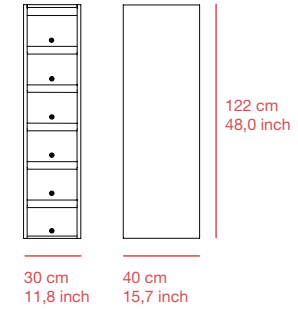

## AQUARIUS S ACCESSORIES



S/CS cylinder lock



S/MS coin lock



S/PCS LS100 pin code lock



S/PCS Mauer pin code lock

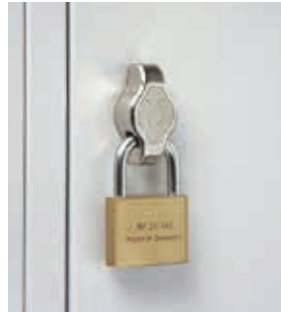

S/HV padlock provision



NP number tag



NH1 name plate holder



NH2 name plate holder



NH3 name plate holder



NH4 number tag

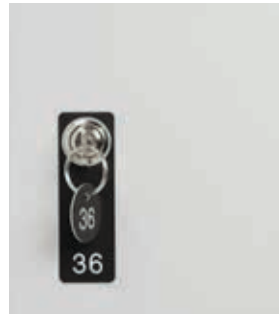

NH4 number tag



NH5 card holder



SN key number tag



S/PN number tag

## STANDAARD KLEUREN STANDARD COLOURS STANDARDFARBEN COLORIS STANDARD

### Locker



RAL 0030  
\*SP excluded



RAL 1013



RAL 1015



RAL 1017



RAL 2002



RAL 3002



RAL 5002



RAL 5010



RAL 5012



RAL 5014



RAL 6011



RAL 6019



RAL 6021



RAL 7016



RAL 7032



RAL 7035



RAL 7040

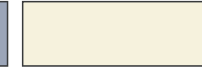

RAL 9001



RAL 9002



RAL 9005



RAL 9006

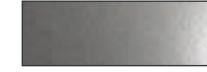

RAL 9007



RAL 9010

### Frame



RAL 9007

### Seat parts



Deal



White plastic

# REFERENTIES REFERENCES REFERENZEN RÉFÉRENCES

RIJKSMUSEUM AMSTERDAM 57  
BERNHOFEN HOSPITAL UDEN 63  
BUREAU JEUGDZORG AMSTERDAM 67  
INDICIA TILBURG 73  
RABOBANK HEAD OFFICE UTRECHT 75  
EUROMEX HEAD OFFICE EDEGEM 83

REFERENCE LIST 87



# RIJKSMUSEUM AMSTERDAM

## RIJKSMUSEUM

Met een spraakmakende ingreep legde architectenbureau Cruz y Ortiz het oorspronkelijke karakter van het Rijksmuseum in Amsterdam bloot. Evengoed is het interieur van deze tijd. Zo is de garderobe met kapstokken, houten kasten en parapluerekken volledig op maat gemaakt. Zelfs de kleeerhangers zijn voor dit project ontwikkeld. In de kleedruimte is gekozen voor stalen kasten met pincodesloten.

Architect's firm Cruz y Ortiz's much talked about re-design of the Rijksmuseum reveals the Amsterdam museum's original character. The interior nonetheless retains a contemporary feel. The cloakroom, for example, with all its coat stands, wooden lockers and umbrella stands, has been fully tailor made. Even the coat hangers were specially designed for this project. The changing rooms are equipped with steel lockers with pin code locks.

Mit einem aufsehenerregenden Eingriff hat das Architekturbüro Cruz Y Ortiz den ursprünglichen Charakter des Rijksmuseums in Amsterdam wiederhergestellt. Die Inneneinrichtung ist allerdings modern und zeitgemäß. Die Garderobe mit Kleiderablagen, Holzschränken und Schirmständern ist eine maßgeschneiderte Lösung. Selbst die Kleiderbügel wurden speziell für dieses Projekt neu entwickelt. In den Umkleieräumen wurden Stahlschränke mit Codeschlössern verwendet.

Par une intervention retentissante, le cabinet d'architectes Cruz y Ortiz a mis à nu le caractère original du Rijksmuseum d'Amsterdam. L'intérieur est cependant contemporain. Le vestiaire et ses portemanteaux, armoires en bois et râteliers à parapluies ont été fabriqués sur mesure. Même les cintres ont été spécialement conçus pour ce projet. Dans les vestiaires, des armoires en acier avec serrures à code confidentiel ont été choisies.











# BERNHOVEN HOSPITAL UDEN

## BERNHOVEN HOSPITAL

Ziekenhuis Bernhoven in Uden voldoet volledig aan de eisen van deze tijd. Het gebouw heeft een warme, bijna persoonlijke uitstraling waardoor zowel patiënten als personeel er zich op hun gemak voelen. De banken, de hakenprofielen en houten lockers, die zijn toegepast in de heren- en dameskleedkamers, sluiten daarbij perfect aan.

Bernhoven hospital in Uden fully meets all the requirements of the modern age. The building has a warm, almost personal feel, making patients and staff alike feel completely at home. The benches, hooks and wooden lockers that have been fitted in the men's and ladies' changing rooms are fully in keeping with this.

Das Krankenhaus Bernhoven in Uden entspricht vollständig den Anforderungen unserer Zeit. Das Gebäude verfügt über eine warme, fast persönliche Ausstrahlung, wodurch sich die Patienten wie auch das Personal wohlfühlen. Die Bänke, Hakenprofile und Holzschränke, die sich in den Herren- und Damen-Umkleideräumen befinden, passen hervorragend dazu.

L'hôpital Bernhoven à Uden répond entièrement aux normes de notre époque. Le bâtiment à un aspect chaleureux, presque intime, qui fait que les patients et le personnel s'y sentent à l'aise. Les bancs, les barres de patères et les casiers en bois, utilisés dans les vestiaires hommes et femmes, contribuent à cette ambiance.







# BUREAU JEUGDZORG AMSTERDAM

## BUREAU JEUGDZORG

Bureau Jeugdzorg gaat uit van de rechten van het kind op een veilige opvoeding. In de kantoorruimtes is gekozen voor vakkenkasten met een houtdecor. Ze accentueren de warme uitstraling van de werkruimtes. De kasten zijn voorzien van pincodesloten.

The Youth Care Office is dedicated to the right of children to have a safe upbringing. The offices have been equipped with lockers with a wood effect, which accentuate the warm feel of the work areas. The lockers have been fitted with pin code locks.

Das Bureau Jeugdzorg vertritt die Rechte zum Schutz von Kindern und Jugendlichen. Für die Büroräume wurden Fächerschränke in Holzoptik ausgewählt. Sie betonen die warme Ausstrahlung der Arbeitsräume. Die Schränke sind mit Codeschlössern ausgerüstet.

Le bureau d'aide sociale à la jeunesse d'Amsterdam base son action sur les droits de l'enfant à une éducation en sécurité. Les espaces de bureaux ont été aménagés avec des armoires de casiers avec décor en bois. Elles accentuent l'ambiance chaleureuse des espaces de travail. Les armoires sont pourvues de serrures à code confidentiel.



1090  
-  
1173





1190  
-  
1219

# INDICIA TILBURG

## INDICIA

Het Tilburgse bedrijf Indicia richt zich op de ontwikkeling van onder meer apps, sites, portals en social media. Gebruiksvriendelijkheid is een tweede natuur. Dat is ook af te lezen aan de inrichting van het kantoorpand aan de rand van het centrum. Daar komen de verschillende houten lockerkasten, Dodici garderobestandaards en bijpassende Drip paraplubakken dan ook uitstekend tot hun recht.

The Tilburg company Indicia specializes in developing, for example, apps, sites, portals and social media. User-friendliness is second nature. That can be clearly seen from the interior of the office that is located at the city centre's edge. Here the various wooden lockers, Dodici cloakroom stands and accompanying Drip umbrella stands look at their very best.

Das Unternehmen Indicia in Tilburg entwickelt Apps, Websites, Portale und Social-Media-Anwendungen. Benutzerfreundlichkeit ist fast seine zweite Natur. Das lässt sich auch an der Einrichtung des Bürogebäudes am Rand des Zentrums ablesen. Dort kommen die verschiedenen Holzschränke, die Dodici Garderobenstände und die dazu passenden Drip Schirmständer auch ausgezeichnet zur Geltung.

L'entreprise de Tilburg Indicia se consacre entre autres au développement d'applications, de sites et de portails et de médias sociaux. La facilité d'utilisation est une seconde nature. Cela se constate à l'aménagement de l'immeuble de bureaux aux abords du centre ville. Les différents casiers en bois, les portemanteaux Dodici et les bacs à parapluies Drip y sont parfaitement à leur place.





# RABOBANK HEAD OFFICE UTRECHT

## RABOBANK HEAD OFFICE

In het door architectenbureau Kraaijvanger ontworpen hoofdkantoor van de Rabobank in Utrecht is gekozen voor een nieuwe manier van werken. In het transparante interieur vinden klanten en medewerkers intuïtief de weg. De speels vormgegeven wandkapstok Wings, evenals de garderobebanken en stalen kasten zijn er op hun plaats. Ze zijn te vinden in kleedruimtes en fietsenstalling.

At the Rabobank head office in Utrecht, designed by architect's firm Kraaijvanger, a new form of working has been adopted. In the transparent interior customers and staff intuitively find their way around. The whimsical design of the Wings coat rack, as well as the cloakroom benches and steel lockers, fit in with this style. They can be found in the changing rooms and bike sheds.

Im vom Architekturbüro Kraaijvanger entworfenen Hauptsitz der Rabobank in Utrecht hat man sich für eine neue Arbeitsweise entschieden. Kunden und Mitarbeiter finden im transparenten Interieur intuitiv ihren Weg. Die spielerische Linienführung der Wandgarderobe Wings sowie auch die Garderobebänke und stahlschränke kommen hier ausgezeichnet zur Geltung. Sie sind in den Umkleieräumen und im Fahrradabstellraum zu finden.

Dans la conception du siège de la banque Rabobank, à Utrecht, le cabinet d'architectes Kraaijvanger a choisi d'utiliser une nouvelle manière de travailler. Dans l'intérieur transparent, les clients et les employés trouvent leur chemin intuitivement. Les portemanteaux muraux riches de fantaisie, ainsi que les bancs de vestiaires et les armoires en acier y sont parfaitement à leur place. Ils se trouvent dans les vestiaires et l'abri pour vélos.













Regenkleding



## EUROMEX HEAD OFFICE

Slim, efficiënt en effectief. Het zijn de belangrijkste kenmerken van het nieuwe werken. Het is dan ook niet vreemd dat Vlaamse rechtsbijstandverzekeraar Euromex er bij de inrichting van het kantoorpand in Edegem voor heeft gekozen. In de open kantoorruimte zijn de houten lockers, die zijn voorzien van een garderobe-element, perfect op hun plaats. Ze dragen bij aan de intimiteit op de werkvloer, zonder afbreuk te doen aan het transparante karakter van de ruimte.

Smart, efficient and effective. These are the most important features of the new way of working. It therefore comes as no surprise that Flemish legal aid insurer Euromex has decided to furnish its offices in Edegem with these features in mind. The wooden lockers, which are fitted with a cloakroom element, fit in perfectly with the open plan office design. They help to add to the intimate feel in the office without detracting from the transparent character of the office space.

Intelligent, effizient und effektiv. Das sind die wichtigsten Merkmale der neuen flexiblen Arbeitswelt. Darum liegt es auch vor der Hand, dass der flämische Rechtsschutzversicherer Euromex bei der Einrichtung des Bürogebäudes in Edegem solchen Eigenschaften den Vorzug gegeben hat. Im offenen Büroraum wirken die Schränke aus Holz, die mit einem Garderobenelement kombiniert werden, wie perfekt für ihren Platz geschaffen. Sie tragen zur Privatsphäre am Arbeitsplatz bei, ohne die Transparenz der Linienführung zu beeinträchtigen.

Ingéniosité, efficacité et effectivité. Telles sont les principales caractéristiques de la nouvelle façon de travailler. Il n'est donc pas étrange que la compagnie flamande d'assurance de protection juridique Euromex ait basé son choix sur les mêmes principes pour l'aménagement de son siège à Edegem. Dans l'espace de bureau ouvert, les casiers en bois, qui sont équipés d'éléments de vestiaires, se trouvent parfaitement à leur place. Ils contribuent à l'intimité du lieu de travail, sans nuire au caractère transparent de l'espace.

vanEsch

# EUROMEX HEAD OFFICE EDEGEM









# REFERENTIES REFERENCES REFERENZEN RÉFÉRENCES

## THE NETHERLANDS

Academisch Ziekenhuis Maastricht, Maastricht	Electrabel, Hoogeveen
Albert Heijn Hoofdkantoor, Zaandam	Elsevier, Den Haag
Albert Schweitzer Ziekenhuis, Dordrecht	Eneco, Breukelen
Alliander-Endinet, Eindhoven	Ernst & Young, Ede
Amsterdams Lyceum, Amsterdam	Essent, Roermond
Anton Jurgenshuis, Oss	Europol, Den Haag
Arbo Unie Zuid, Breda	FC Utrecht, Utrecht
ASML, Veldhoven	Fontys Hogeschool, Various locations
Astellas, Leiden	Fortis Bank, Various offices
Avans Hogeschool, Den Bosch	Frits Philips Museum, Eindhoven
AZ, Alkmaar	Gemeente Amersfoort, Amersfoort
Bavaria, Lieshout	Gemeente Amsterdam, Amsterdam
Bavo Europoort, Capelle aan den IJssel	Gemeente Ede, Ede
Belastingdienst, Arnhem, Zwolle	Gemeente Eindhoven, Eindhoven
Bernhoven ziekenhuis, Uden	Gemeente Haarlemmermeer, Hoofddorp
Bibliotheek Nijmegen, Nijmegen	Gemeente Utrechtste Heuvelrug, Doorn
Bovag, Bunnik	GGD Rivierland, Tiel
Brabant Water, Den Bosch	Go Ahead Eagles, Deventer
Brandweer, Various locations	Golfbaan Efteling, Kaatsheuvel
Bronovo Ziekenhuis, Den Haag	Groene Land Verzekeringen, Meppel
Bureau Jeugdzorg, Various locations	Grolsche Bierbrouwerij Nederland, Enschede
C1000, Dronten	Hardy's, Tilburg
Cambium College, Sint Oedenrode	HBG Civiel, Amsterdam
Chassé Theater, Breda	Heineken, Various locations
Concert- en gehoorzaal, Middelburg	HEMA, Amersfoort
Cultureel Centrum Elckerlyc, Hilvarenbeek	Hitachi, Zaltbommel
Cultureel Centrum Jan van Besouw, Goirle	Hoogheemraadschap Delfland, Delft
CWI Hoofdkantoor, Utrecht	Hoogheemraadschap Rijnland, Leiden
CZ, Tilburg	Indicia, Tilburg
De Monarch I, Den Haag	ING Bank, Various locations
De Nieuwe Vorst, Tilburg	Jeroen Bosch Ziekenhuis, Den Bosch
De Rooi Pannen, Tilburg	Joop Ooms Sport, Berkel-Enschot
Dela, Hilvarenbeek	KLM, Amsterdam
Detentiecentrum Schiphol, Schiphol	KLPD, Various locations
Drents Archief, Assen	Koninklijke Douwe Egberts, Amsterdam
DWI Triade, Amsterdam	KPN, Amsterdam
	Kruidvat Retail, Heteren
	KVK, Middelburg
	Landal Green Parcs, t Loo

Living Tomorrow, Amsterdam  
 Maxima Medisch Centrum, Veldhoven  
 Meeùs, Various locations  
 Ministerie van Buitenlandse Zaken, Den Haag  
 Ministerie van Financiën, Den Haag  
 MMKA, Arnhem  
 Muziekcentrum F. Philips, Eindhoven  
 Nationaal Archief, Den Haag  
 Naturalis, Leiden  
 Nederlandse Gasunie, Groningen  
 Nederlandse Spoorwegen, Various locations  
 NIFV, Arnhem  
 Nuon, Alkmaar  
 Ohra, Arnhem  
 Orbis Medisch en Zorgconcern, Sittard  
 OZ, Breda  
 Parnassia, Various locations  
 Penitentiare Inrichting, Various locations  
 Philips, Eindhoven  
 Politie, Various locations  
 Prodrive, Eindhoven  
 Provinciehuis, Arnhem, Den Bosch  
 PSV De Herdang, Eindhoven  
 Rabobank, Various offices  
 Radboud Ziekenhuis, Nijmegen  
 Rechtbank, Arnhem, Zwolle  
 Reed Elsevier, Amsterdam  
 Rijksmuseum, Amsterdam  
 Rijkswaterstaat, Various locations  
 Rijnland Ziekenhuis, Leiderdorp  
 ROC, Various locations  
 Roda JC, Kerkrade  
 Royal Canin, Veghel  
 Sanoma Uitgevers, Hoofddorp  
 Sanquin Bloedbank, Various locations  
 School voor de Toekomst, Den Bosch  
 Schouwburg, Amstelveen, Deventer  
 Sensire, Varsseveld  
 Sony, Heerlen  
 Sparta, Rotterdam  
 Stedelijk Museum, Amsterdam  
 T.S.V. NOAD, Tilburg  
 Thermaal Bad, Arcen  
 TNT, Hoofddorp  
 Transavia, Amsterdam  
 Twee Steden Ziekenhuis, Tilburg  
 Universiteit, Various locations  
 UWW, Various locations  
 Van Abbemuseum, Eindhoven  
 VGZ, Eindhoven  
 VUMC, Amsterdam  
 Wageningen Universiteit & Researchcentrum, Wageningen  
 Waterschap Zuiderzeeland, Lelystad  
 Willem II, Tilburg  
 Wipro, High Tech Campus, Eindhoven  
 Woodschoten Hotel en Conferentiecentrum, Zeist  
 Zuiderkerk, Middelburg  
 Zwembad, Various locations  
 Zwitterleven, Amstelveen

**BELGIUM**  
 Alcatel Bell, Antwerpen, Mechelen  
 AXA, Brussel  
 Belgacom, Brussel  
 Blue Green Golf, Durbuy  
 BMW Garage, Antwerpen  
 Cap Gemini, Diegem  
 Centre Sportif, Flobecq  
 CMG, Berchem  
 Coca-Cola, Gosselies  
 Culinor, Destelbergen  
 Cultureel Centrum Middelkerke, Middelkerke  
 De Lijn, Brussel  
 Digipolis, Antwerpen  
 Elia, Brussel

Erasmus Huis, Leuven  
 Euromex, Edegem  
 Europese Commissie, Brussel  
 Europese Unie, Brussel  
 Heizel Stadion, Brussel  
 Hogeschool voor de Kunsten, Antwerpen  
 Interbrew, Leuven  
 Janssen Pharmaceutica, Beerse  
 Karel de Grote-Hogeschool, Antwerpen  
 Katholieke Hogeschool Kempen, Vorselaar  
 KBC Bank, Various offices  
 KPC, Genk  
 Maria Ziekenhuis Noord-Limburg, Overpelt  
 Mobistar, Brussel  
 Nationale Bank, Brussel  
 NMBS, Brussel  
 OCMW, Gent  
 Ordina, Hasselt  
 Pfizer, Brussel  
 Plantin bvba, Brussel  
 Price Waterhouse Coopers, Gent  
 Provinciehuis aan de Singel, Antwerpen  
 Sofitel, Brussel  
 Sportcomplex Leuven, Leuven  
 Sporthal Haneveld, De Haan  
 TNT, Luik  
 Tupperware, Aalst  
 Union Minière, Olen  
 Universitair Ziekenhuis, Brussel, Leuven  
 Universiteit, Gent, Leuven  
 VRT, Brussel  
 VTM, Vilvoorde  
 Zwembad, St. Niklaas en Gent

**GERMANY**

Aldi KG, Grossbeeren, Konstanz  
 Allianz Versicherungen, München  
 BASF, Schwarzheide, Willstätt  
 Bayer AG, Krefeld, Leverkusen

Bildungszentrum der Wirtschaft, Essen  
 BMW AG, Dingolfing  
 Coca-Cola, Berlin  
 Deutsche Bahn AG, Saarbrücken  
 Dresdener Bank, Frankfurt  
 Dunlop GmbH, Hanau  
 Esso AG, Ingolstadt  
 Fachhochschule, Oldenburg  
 Festhalle, Viersen  
 Flughafen Köln-Bonn, Köln  
 Herzog Christoph Gymnasium, Beilstein  
 IB Bildungszentrum, Ludwigsburg  
 Lufthansa Technik Hamburg, Hamburg  
 MAN AG, München  
 Messe, Essen, Hannover  
 Nestlé Deutschland AG, Herten  
 Nürburgring GmbH, Nürburg  
 Oracle Software, Düsseldorf  
 Philips, Hamburg  
 Siemens AG, Müllheim  
 Thyssen Krupp Stahl, Duisburg  
 TÜV, Essen  
 Vodafone/D2, Düsseldorf  
 Volksbank AG, Marsberg, Hannover

**LUXEMBOURG**

Air Luxembourg, Luxembourg  
 Centre guillaume II Ville de Luxembourg, Luxembourg  
 Hôpital Intercommunal de Steinfort, Steinfort  
 ING, Luxembourg  
 Paleis van Justitie, Luxembourg  
 Price Waterhouse Coopers, Luxembourg  
 Salle de Concert, Kirchberg

**AUSTRIA**

Culturhaus, Brixen  
 Universität, Graz, Kapfenberg, Wien

**CZECH REPUBLIC**

Skoda Showrooms, Czech Republic

**DENMARK**

Conference Center, Herning  
Ford/Mazda Finance, Kopenhagen  
Maersk Oil and Gas, Kopenhagen  
Ogilvi + Mather, Kopenhagen  
Oracle, Ballerup  
SAS Business Travel, Kopenhagen

**FINLAND**

TeliaSonera, Helsinki

**FRANCE**

Bibliothèque, Tours  
Blue Green Golf, Various locations  
Lycée Technique, Mersch

**GEORGIA**

Archstudia, Tbilisi

**GREAT-BRITAIN**

ABN Amro, London  
Bank of England, London  
Department of Works and Pensions, Leeds  
Orange, London  
Porsche, London  
Wimbledon, London

**DUBAI**

KAPSARC, Dubai

**IRAN**

Embassy H.M., Teheran

**MAROC**

University Mohammed VI, Casablanca

**MONACO**

Gramaglia, Monaco

**POLAND**

HSBC, Warschau

**SCOTLAND**

Bank of Scotland, Edinburgh

**SWITZERLAND**

Musée Olympique, Lausanne

**CAMEROON**

Chancery Office, Yaounde

**CANADA**

Vancouver Convention Center, Vancouver

**INDIA**

Ambassade New Delhi, New Delhi

**PHILIPPINES**

Embassy H.M., Manila

**USA**

Airport Atlanta Heartfield, Atlanta  
The White House, Washington DC

**SPECIAL THANKS TO:**

**THE NETHERLANDS**

Bernhoven ziekenhuis, Uden  
Bureau Jeugdzorg Agglomeratie  
Amsterdam, Amsterdam  
Cultureel Centrum Jan van Besouw, Goirle  
Digibiz, De Jamfabriek, Den Bosch  
Indicia, Tilburg  
Rabobank Nederland, Utrecht  
Rijksmuseum, Amsterdam  
Unitedstudios, Den Bosch

**BELGIUM**

Euromex, Edegem

**Concept and Design**

Peer Dobbelsteen, 's-Hertogenbosch  
The Netherlands

**Photography**

Chris van den Bijgaart, Moergestel  
The Netherlands

**Printing**

NPN Drukkers, Breda  
The Netherlands

Copyright© van Esch 2014

All rights reserved

**van Esch bv**

Edisonstraat 5

NL-5051 DS GOIRLE

Tel. +31 (0)13 534 87 38

Fax +31 (0)13 534 87 60

[info@van-esch.com](mailto:info@van-esch.com)

[www.van-esch.com](http://www.van-esch.com)



van Esch bv  
Edisonstraat 5  
NL-5051 DS GOIRLE  
Tel. +31 (0)13 534 87 38  
Fax +31 (0)13 534 87 60  
[info@van-esch.com](mailto:info@van-esch.com)  
[www.van-esch.com](http://www.van-esch.com)