

take off

evolution



take off

evolution

index

take off evolution	2
evo	4
country	30
farm	48
technical	66

take off

evolution

evo

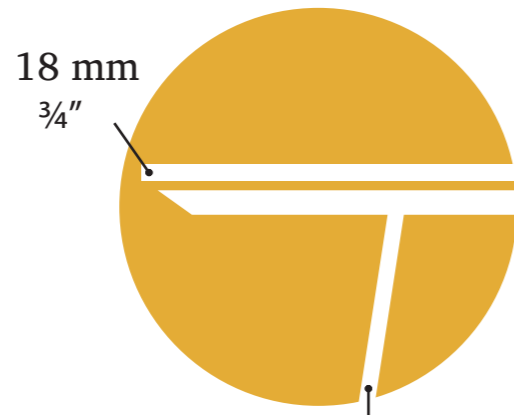

metallo - metal - métal
metall - metaal - metal

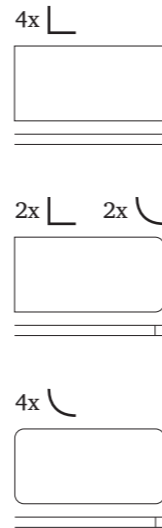

P. 60 / 80 / 100 cm
P. 23 1/4" / 31 1/2" / 39 1/4"

P. 124 / 164 cm
P. 48 3/4" / 64 1/2"

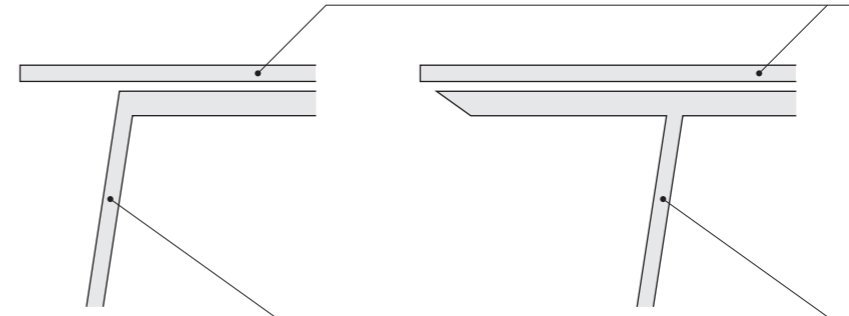

country

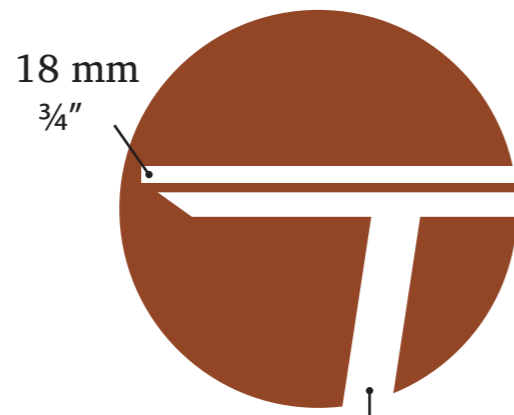
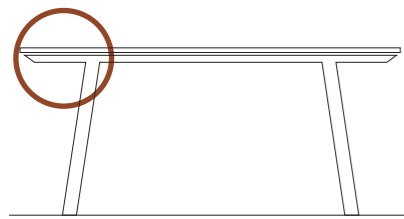

rivestito - coated - revêtu
beschichtete - bekleed - revestido

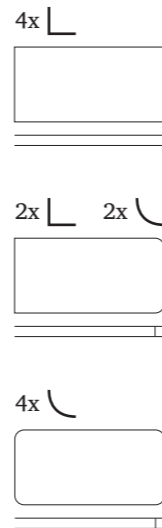

P. 100 / 124 / 164 cm
P. 39 1/4" / 48 3/4" / 64 1/2"

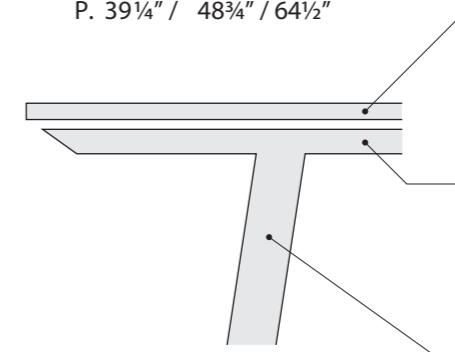

farm

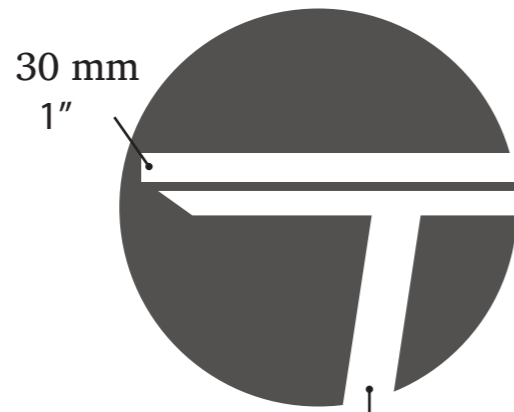
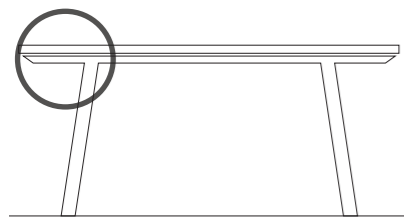

rivestito - coated - revêtu
beschichtete - bekleed - revestido

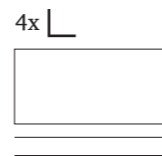

P. 100 / 124 / 164 cm
P. 39 1/4" / 48 3/4" / 64 1/2"

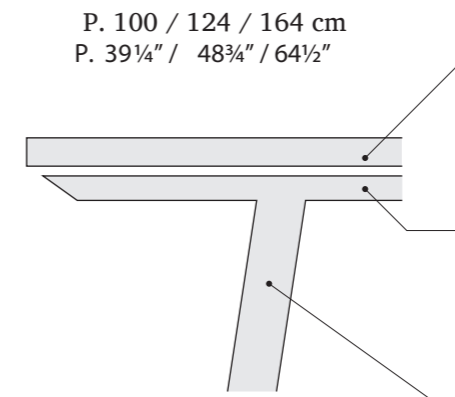

take off
evolution

evo



take off

evolution **evo**

Gambe: verniciate epox bianco / **Piani + modesty panel:** melaminico wengé scuro / **Fianchi e top armadio + mobile:** melaminico bianco / **Ante armadio:** vetro temperato tortora e melaminico nebbia / **Maniglie:** KR

Beine: Pulverlackiert Weiß / Tischplatten + Knieraumblenden: Melamin dunkel Wengé / Seitenverkleidungen und Schrank-abdeckungen + Container: Melamin Weiß / Schranktüren: gehärtetes Glas Taubengrau und Melamin Nebelgrau / Griffe KR

Legs: white painted epoxy resin / Tops + modesty panels: dark wengé melamine wood / Finishing sides and top + cabinet: white melamine wood / Hinged doors: light grey coloured tempered glass and fog coloured melamine / Handles KR

Poten: gelakt epoxy wit / Bladen + knieschotten: donker wengé melamine / Zijpanelen en top kast + meubel: wit melamine / Deuren kast: duifgrijs kleurig gehard glas en mistkleurig melamine / Handgrepen KR

Pieds: peints époxy blanc / Dessus + voile de fond: mélaminé wengé foncé / Côtés et dessus placard + meuble: mélaminé blanc / Portes armoires: verre trempé tourterelle et mélaminé brouillard / Poignées KR

Patas: barnizadas epoxi blanco / Sobres + faldon: melamina wengé oscuro / Costados y techo armario + mueble: melamina blanco / Puertas armario: cristal templado gris ceniciento y melamina niebla / Manillas KR





Gambe: verniciate epox nero / Piano + modesty panel: melaminico wengé scuro / Fianchi e top armadio + mobile: melaminico nero / Ante armadio: vetro temperato tortora / Maniglie KR

Beine: Pulverlackiert Schwarz / Tischplatten + Knieraumblenden: Melamin dunkel Wengé / Seitenverkleidungen und Schrankabdeckungen + Container: Melamin Schwarz / Schranktüren: gehärtetes Glas Taubengrau / Griffe KR

Legs: black painted epoxy resin / Top + modesty panels: dark Wengé melamine / Finishing sides and top + cabinet: black melamine / Closet doors: light grey coloured tempered glass / Handles KR

Poten: gelakt epoxy zwart / Blad + knieschotten: donker wengé melamine / Zijpanelen en top kast + meubel: zwart melamine / Deuren kast: duifgrijs kleurig gehard glas / Handgrepen KR

Pieds: peints époxy noir / Dessus + voile de fond: mélaminé wengé foncé / Côtés et dessus placard + meuble: mélaminé noir / Portes armoires: verre trempé tourterelle / Poignées KR

Patas: barnizadas epoxi negro / Sobre+faldon: melamina wengé oscuro / Costados y techo armario + mueble: melamina negra / Puertas armario: cristal templado gris ceniciento / Manillas KR



Colonna e base verniciate epox tortora / Piano: melaminico wengé scuro

Säule und Bodenteller pulverlackiert Taubengrau / Tischplatte: Melamin dunkel Wengé

Column and base: light grey painted epoxy resin / Top: dark wengé melamine wood

Kolom of basis gelakt epoxy duifgrijs / Blad: donker wengé melamine

Colonne et base peints époxy tourterelle / Dessus: mélaminé wengé foncé

Columna y base barnizadas epoxi gris ceniciento / Sobre: melamina wengé oscuro

Gambe: verniciate epox bianco / Piano + modesty panel: melaminico wengé scuro / Mobile: melaminico bianco / Maniglie bianche

Legs: white painted epoxy resin / Top + modesty panels: darker wengé melamine wood / Cabinet: white melamine wood / White handles

Pieds: peints époxy blanc / Dessus + voile de fond: mélaminé wengé foncé / Meuble: mélaminé blanc / Poignées blanches

Beine: Pulverlackiert Weiß / Tischplatten + Knieraumblenden: Melamin dunkel Wengé / Container: Melamin Weiß / Weiße Griffe

Poten: gelakt epoxy wit / Blad + knieschotten: donker wengé melamine / Meubel: wit melamine / Wit handgrepen

Patas: barnizadas epoxi blanco / Sobre +faldon: melamina wengé oscuro / Mueble: melamina blanco / Manillas blancas



Fianchi e top armadio: melaminico bianco / Ante armadio: melaminico tortora / Maniglie KR

Finishing sides and top: white melamine wood / Closet sides: light grey coloured melamine wood / Handles KR

Côtés et dessus placard: mélaminé blanc / Portes armoires: mélaminé tourterelle / Poignées KR

Seitenverkleidungen und Schrankabdeckungen: Melamin Weiß / Schranktüren: Melamin Taubengrau / Griffe KR

Zijpanelen en top kast: wit melamine / Deuren kast: duifgrijs kleurig melamine / Handgrepen KR

Costados y techo armario: melamina blanca / Puertas armario: melamina gris ceniciento / Manillas KR



take off

evolution **evo**

**Gambe + porta cpu: verniciate epox bianco /
Piani + schermi + cassetiere + vertical file: melaminico bianco / Piano tavolo + ante Ubi: melaminico noce canaletto / Ubi: melaminico bianco / Passacavi tavolo: tessuto Puma - Nero**

Beine + Computerträger: Pulverlackiert Weiß /
Tischplatten + Sichtschutz + Container + Vertical File: Melamin Weiß / Tischplatte + Türen Ubi: Melamin Canaletto Nußbaum / Ubi: Melamin Weiß Tisch-Kabel-durchlass: Stoff Puma - Schwarz

Legs + CPU holder: white painted epoxy resin /
Tops + panels + drawers + vertical file: white melamine wood /
Table top + Ubi doors: Canaletto walnut melamine wood /
Ubi: white melamine wood /
Table cable holder: Puma - Black fabric

Poten + CPU-houder: gelakt epoxy wit /
Bladen + schermen + ladenkasten + hangmappen: wit melamine /
Tafelblad + deuren Ubi: notenkleurig melamine geleiding /
Ubi: wit melamine /
Kabeldoorvoer tafel: stof Poema - Zwart

Pieds + porte-CPU: peints époxy blanc /
Dessus + écrans + caissons + classeur vertical: mélaminé blanc /
Dessus table + vantaux Ubi: mélaminé noyer canaletto /
Ubi: mélaminé blanc /
Passe-câbles table: tissu Puma - Noir

Patas + soporte para cpu: barnizadas epoxi blanco /
Sobres + pantallas + cajoneras + archivador vertical: melamina blanco /
Sobre mesa + puertas Ubi: melamina nogal negro /
Ubi: melamina blanco /
Pasacables mesa: tejido Puma - Negro





Gambe: verniciate epox tortora / Ante e frontali Ubi: melaminico tortora / Ubi: melaminco bianco

Beine: Pulverlackiert Taubengrau / Türen und Fronten Ubi: Melamin Taubengrau / Ubi: Melamin Weiß

Legs: light grey painted epoxy resin / Ubi doors and front panels: grey melamine wood / Ubi: white melamine wood

Poten: gelakt epoxy duifgrijs / Deuren en voorpanelen Ubi: duifgrijs melamine / Ubi: wit melamine

Pieds: peints époxy tourterelle / Portes et façades Ubi: mélaminé tourterelle / Ubi: mélaminé blanc

Patatas: barnizadas epoxi gris ceniciento / Puertas y frentes Ubi: melamina gris ceniciento / Ubi: melamina blanco

Gambe: verniciate epox bianco / Ubi: melaminico bianco / Piano tavolo + ante Ubi: melaminico rovere naturale / Passacavi tavolo: tessuto Puma - Nero

Beine: Pulverlackiert weiß / Tischplatte + Türen Ubi: Melamin Eiche natur / Tisch-Kabeldurchlass: Stoff Puma - Schwarz

Legs: white painted epoxy resin / Ubi: white melamine wood / Table top + Ubi doors: Natural oak melamine / Table cable holder: Puma - Black fabric

Poten: gelakt epoxy wit / Ubi: wit melamine / Tafelblad + deuren Ubi: natuurlijk eiken Melamine / Kabeldoorvoer tafel: stof Poema - Zwart

Pieds: peints époxy blanc / Ubi: mélaminé blanc / Dessus table + façades Ubi: mélaminé chêne naturel / Passacables table: tissu Puma - Noir

Patatas: barnizadas epoxi blanco / Ubi: melamina blanco / Sobre mesa + puertas Ubi: melamina roble natural / Pasacables mesa: tejido Puma - Negro



Gambe + porta cpu: verniciate epox bianco / Piani + vertical file: melaminico bianco

Legs + CPU holder: white painted epoxy resin / Tops + vertical file: white melamine wood

Pieds + porte-CPU: peints époxy blanc / Dessus + classeur vertical: mélaminé blanc









Beine + Computertträger: Pulverlackiert Weiß / Tischplatten + Vertical File: Melamin Weiß

Poten + CPU-houder: gelakt epoxy wit / Bladen + schermen + hangmappen: wit melamine

Patatas + soporte para cpu: barnizadas epoxi blanco / Sobres + archivador vertical: melamina blanco



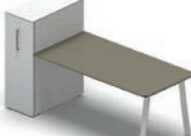









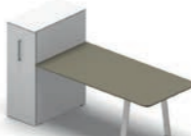

Alcuni esempi di possibili configurazioni - Some examples of possible layouts - Voici quelques exemples de configurations possibles - Einige Beispiele von möglichen Konfigurationen - Een aantal voorbeelden van mogelijke configuraties - Algunos ejemplos de configuraciones posibles

10/11	12/13	cm	inch	angle
	<p>Scrivanía con cassetiera portante Desk with drawer unit Bureau avec caisson portant Schreibtisch mit Stützcontainer Bureau met dragende ladenblok Escritorio con cajonera portante</p> <p>• CM.0408.M4</p>	L. 140 ÷ 240 P. 80 H. 72	L. 55" ÷ 94½" P. 31½" H. 28¼"	4x 
	<p>Scrivanía con vertical file Sx Desk with left vertical file Bureau avec classeur vertical gauche Schreibtisch mit Vertical File links Bureau met hangmappen links Escritorio con archivadores verticales izquierdo</p> <p>• CM.0408.ES</p>	L. 140 ÷ 240 P. 80 H. 72	L. 55" ÷ 94½" P. 31½" H. 28¼"	4x 
	<p>Scrivanía con cassetiera portante Desk with drawer unit Bureau avec caisson portant Schreibtisch mit Stützcontainer Bureau met dragende ladenblok Escritorio con cajonera portante</p> <p>• CM.0408.M3</p>	L. 140 ÷ 240 P. 80 H. 72	L. 55" ÷ 94½" P. 31½" H. 28¼"	2x  2x 
	<p>Scrivanía con vertical file Sx e top Desk with left vertical file and top Bureau avec classeur vertical gauche et dessus Schreibtisch mit Vertical File links und Abdeckplatte Bureau met hangmappen links en top Escritorio con archivadores verticales izquierdo y sobre</p> <p>• CM.1108.ES</p>	L. 140 ÷ 280 P. 80 H. 72	L. 55" ÷ 110¼" P. 31½" H. 28¼"	2x  2x 

Per una più completa visione della collezione, consultare il listino
 Pour un meilleur aperçu de la collection, veuillez consulter la liste des prix
 Om de volledige collectie te raadplegen, zie de lijst

To view the collection in more detail, Please refer to our price list
 Eine komplette Ansicht der Kollektion finden Sie in der Preisliste
 Para ver más detalladamente la colección, consultar la tarifa

10/11	12/13	cm	inch	angle
	<p>Scrivanía con cassetiera portante Desk with drawer unit Bureau avec caisson portant Schreibtisch mit Stützcontainer Bureau met dragende ladenblok Escritorio con cajonera portante</p> <p>• CM.0408.M3</p>	L. 180 ÷ 240 P. 80 H. 72	L. 70¾" ÷ 94½" P. 31½" H. 28¼"	4x 
	<p>Scrivanía con vertical file Dx Desk with right vertical file Bureau avec classeur vertical droit Schreibtisch mit Vertical File rechts Bureau met hangmappen rechts Escritorio con archivadores verticales derecho</p> <p>• CM.0408.ED</p>	L. 180 ÷ 240 P. 80 H. 72	L. 70¾" ÷ 94½" P. 31½" H. 28¼"	2x  2x 
	<p>Scrivanía con vertical file Sx e top Desk with left vertical file and top Bureau avec classeur vertical gauche et dessus Schreibtisch mit Vertical File links und Abdeckplatte Bureau met hangmappen links en top Escritorio con archivadores verticales izquierdo y sobre</p> <p>• CM.1108.ES</p>	L. 180 ÷ 280 P. 80 H. 72	L. 70¾" ÷ 110¼" P. 31½" H. 28¼"	2x  2x 
	<p>Scrivanía + dattilo appeso Desk + workwall Bureau + dactylo suspendu Schreibtisch + Andocktisch Bureau + oplegtafel Escritorio + ala escritorio suspendida</p> <p>L. 140 ÷ 240 P. 80 + 120 x 60 H. 72</p> <p>L. 160 ÷ 240 P. 100 + 120 x 60 H. 72</p>	L. 55" ÷ 94½" P. 31½" + 47¼" x 23¾" H. 28¼"	L. 63" ÷ 94½" P. 39¼" + 47¼" x 23¾" H. 28¼"	2x  2x 
	<p>Scrivanía + dattilo appeso con cassetiera portante Desk + workwall with drawer unit Bureau + dactylo suspendu avec caisson portant Schreibtisch + Andocktisch mit Stützcontainer Bureau + oplegtafel met dragende ladenblok Escritorio + ala escritorio suspendida con cajonera portante</p> <p>L. 140 ÷ 240 P. 80 + 120 x 60 H. 72</p> <p>L. 160 ÷ 240 P. 100 + 120 x 60 H. 72</p> <p>• CM.0407.M4</p>	L. 55" ÷ 94½" P. 31½" + 47¼" x 23¾" H. 28¼"	L. 63" ÷ 94½" P. 39¼" + 47¼" x 23¾" H. 28¼"	2x  2x 

take off

evolution **evo**

Gambe: verniciate epox bianco / **Piani + vertical file + mobile portante + Ubi:** melaminico bianco / **Schermi:** laccato oceano

Poten: gelakt epox wit / Bladen + vertical files + draagmeubel + Ubi: wit melamine / Schermen: gelakt oceaanblauw

Legs: white painted epoxy resin / Tops + vertical file + supporting structure + Ubi: white melamine wood / Panels: ocean blue lacquered wood

Poten: gelakt epoxy wit / Bladen + hangmappen + draagmeubel + Ubi: wit melamine / Schermen: gelakt oceaanblauw

Pieds: peints époxy blanc / Dessus + classeur vertical + meuble portant + Ubi: mélaminé blanc / Écrans: laqué océan

Patas: barnizadas epoxi blanco / Sobres + archivador vertical + mueble portante + Ubi: melamina blanco / Pantallas: lacado océano





Gambe: verniciate epox bianco / Piani + mobili portanti + Ubi: melaminico bianco / Schermi: tessuto Puma-Bordeaux e laccato verde muschio

Legs: white painted epoxy resin / Tops + supporting structures + Ubi: white melamine wood / Panels: Puma - Burgundy fabric and musk green lacquered wood

Pieds: peints époxy blanc / Dessus + meubles portants + Ubi: mélaminé blanc / Écrans: tissu Puma - Bordeaux et laqué vert mousse

Beine: Pulverlackiert weiß / Tischplatten + Stützsideboard + Ubi: Melamin Weiß / Sichtschutz: Stoff Puma - Bordeaux, lackiert Moosgrün

Poten: gelakt epoxy wit / Bladen + draagmeubels + Ubi: wit melamine / Schermen: stof Poema - Bordeaux, gelakt muskusgroen

Patas: barnizadas epoxi blanco / Sobres + muebles portantes + Ubi: melamina blanco / Pantallas: tejido Puma - Burdeos, / lacado verde musgo



Gambe + cassettino: verniciati epox bianco / Piani + mobili portanti + Ubi: melaminico bianco / Schermi: laccato giallo gold

Beine + Schublade: Pulverlackiert weiß / Tischplatten + Stützsideboard + Ubi: Melamin Weiß / Sichtschutz: lackiert Gold-gelb

Legs+ drawer: white painted epoxy resin / Tops + supporting structures + Ubi: white melamine wood / Panels: gold lacquered wood

Poten + lade: gelakt epoxy wit / Bladen + draagmeubels + Ubi: wit melamine / Schermen: gelakt goudgeel

Pieds + tiroir: peints époxy blanc / Dessus + meubles portants + Ubi: mélaminé blanc / Écrans: laqué jaune or

Patas + cajón: barnizadas epoxi blanco / Sobres + muebles portantes + Ubi: melamina blanco / Pantallas: lacado amarillo gold

Gambe + cassettino: verniciati epox bianco / Piani + mobili portanti + Ubi: melaminico bianco / Schermi: laccato nebbia

Legs + drawer: white painted epoxy resin / Tops + supporting structures + Ubi: white melamine wood / Panels: fog coloured lacquered wood

Pieds + tiroir: peints époxy blanc / Dessus + meubles portants + Ubi: mélaminé blanc / Écrans: laqué brouillard

Beine + Schublade: Pulverlackiert weiß / Tischplatten + Stützsideboard + Ubi: Melamin Weiß / Sichtschutz: lackiert Nebelgrau

Poten + lade: gelakt epoxy wit / Bladen + draagmeubels + Ubi: wit melamine / Schermen: gelakt mistkleurig

Patas + cajón: barnizadas epoxi blanco / Sobres + muebles portantes + Ubi: melamina blanco / Pantallas: lacado niebla



take off

evolution **evo**



**Gambe + cassettiere: verniciate epox bianco /
Piani + ante armadio: melaminico acero champagne
/ Fianchi e top armadio: melaminico bianco**

Legs + drawers: white painted epoxy resin / Tops +
hinged doors: champagne hard maple melamine /
Finishing sides and top: white melamine wood

Pieds + caissons: peints époxy blanc / Dessus
+ portes armoires: mélaminé érable champagne /
Côtés et dessus placard: mélaminé blanc

Beine + Container: Pulverlackiert Weiß / Tischplatten +
Schränktüren: Melamin champagnerahorn / Seitenverklei-
dungen und Schrankabdeckungen: Melamin Weiß

Poten + ladenkasten: gelakt epoxy wit / Bladen +
deuren kast: melamine esdoorn champagne
/ Zijpanelen en top kast: wit melamine







Patas + cajoneras: barnizadas epoxi blanco /
Sobres + puertas armario: melamina arce champán /
Costados y techo armario: melamina blanco

Alcuni esempi di possibili configurazioni - Some examples of possible layouts - Voici quelques exemples de configurations possibles - Einige Beispiele von möglichen Konfigurationen - Een aantal voorbeelden van mogelijke configuraties - Algunos ejemplos de configuraciones posibles

Per una più completa visione della collezione, consultare il listino
 Pour un meilleur aperçu de la collection, veuillez consulter la liste des prix
 Om de volledige collectie te raadplegen, zie de lijst

To view the collection in more detail, Please refer to our price list
 Eine komplette Ansicht der Kollektion finden Sie in der Preisliste
 Para ver más detalladamente la colección, consultar la tarifa

16/17 18/19		cm	inch	angle
	Tavolino Small table Petit table Kaffeetisch Kleine tafel Mesa	L. 60 P. 60 H. 43	L. 23 3/4" P. 23 3/4" H. 17"	 4x ↙
	Tavolino Small table Petit table Kaffeetisch Kleine tafel Mesa	L. 120 P. 60 H. 43	L. 47 1/4" P. 23 3/4" H. 17"	 4x ↙
	Tavolo con colonna diam.10 e base diam.59 Table with diam. 10 column and diam. 59 base Table avec colonne diam.10 et base diam.59 Tisch mit Säule Durchmesser.10 und Bodenplatte Durchmesser.59 Tafel met kolom diam. 10 en voetstuk diam. 59 Mesa con columna diám.10 y base diám.59	L. 100xP. 100 P. 120xP. 120 H. 72	L. 39 1/4" x P. 39 1/4" P. 47 1/4" x P. 47 1/4" H. 28 1/4"	 4x ↙
	Tavolo sagomato con colonna e base Shaped table with column and base Table elliptique avec colonne et base Tisch geformt mit Säule und Bodenplatte Gevormde tafel met kolom en basis Mesa ovalada con columna y base	L. 220 P. 124 H. 75	L. 86 3/4" P. 48 3/4" H. 29 1/2"	 4x ↙
	Tavolo sagomato con colonna e base e 1 top access Shaped table with column and base and 1 top access Table elliptique avec colonne et base et 1 top access Tisch geformt mit Säule und Bodenplatte und 1 Top Access Gevormde tafel met kolom en basis en 1 toegang Mesa ovalada con columna y base y 1 acceso superior	L. 220 P. 124 H. 75	L. 86 3/4" P. 48 3/4" H. 29 1/2"	 4x ↙

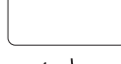
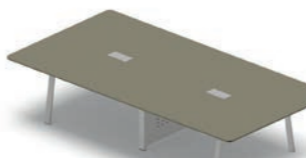
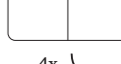
16/17 18/19		cm	inch	angle
	Tavolo con 2 top access Table with 2 top accesses Table avec 2 top access Tisch mit 2 Top Access Tafel met 2 toegangen Mesa con 2 accesos superiores	L. 220 ÷ 240 P. 80 - 100 H. 72	L. 86 3/4" ÷ 94 1/2" P. 31 1/2" - 39 1/4" H. 28 1/4"	 4x ↙
	Tavolo con gamba intermedia con pannello di tamponamento e 2 top access Table middle leg with infill panel and 2 top accesses Table avec pied intermédiaire avec panneaux de fermeture et 2 top access Tisch mit Zwischenbein, Verkleidungspaneel, 2 Top Access Tafel met tussenpoot met tussenpaneel en 2 toegangen Mesa con pata intermedia con tablero compensación y 2 accesos superiores	L. 320 ÷ 400 P. 100 H. 72	L. 126" ÷ 157 1/2" P. 39 1/4" H. 28 1/4"	 4x ↙
	Tavolo Table Table Tisch Tafel Mesa	L. 220 ÷ 280 P. 124 - 164 H. 72	L. 86 3/4" ÷ 110 1/4" P. 48 3/4" - 64 1/2" H. 28 1/4"	 4x ↙
	Tavolo con 2 top access Table with 2 top accesses Table avec 2 top access Tisch mit 2 Top Access Tafel met 2 toegangen Mesa con 2 accesos superiores	L. 220 ÷ 280 P. 124 - 164 H. 72	L. 86 3/4" ÷ 110 1/4" P. 48 3/4" - 64 1/2" H. 28 1/4"	 4x ↙
	Tavolo con gamba intermedia con pannello di tamponamento e 2 top access Table middle leg with insulation panel and 2 top accesses Table avec pied intermédiaire avec panneaux de fermeture et 2 top access Tisch mit Zwischenbein, Verkleidungsfassade, 2 Top Access Tafel met tussenpoot met tussenpaneel en 2 toegangen Mesa con pata intermedia con tablero compensación y 2 accesos superiores	L. 320 ÷ 480 P. 124 - 164 H. 72	L. 126" ÷ 189" P. 48 3/4" - 64 1/2" H. 28 1/4"	 4x ↙

take off

evolution **evo**

Gambe: verniciate epox bianco / **Piano + ante armadio:** rovere naturale / **Schermo + cassettiere + vertical file:** melaminico bianco

Beine: Pulverlackiert weiß / **Tischplatte + Schranktüren:** Eiche natur / **Sichtschutz + Container + Vertical File:** Melamin Weiß

Legs: white painted epoxy resin / **Top + closet doors:** natural oak wood / **Panel + drawers + vertical file:** white melamine wood

Poten: gelakt epoxy wit / **Blad + deuren kast:** natuurlijk eiken / **Scherm + ladenkasten + hangmappen:** wit melamine

Pieds: peints époxy blanc / **Dessus + Portes armoires:** chêne naturel / **Écran + caissons+ classeur vertical:** mélaminé blanc













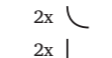



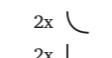

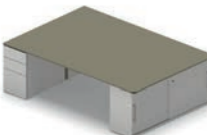

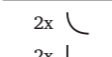

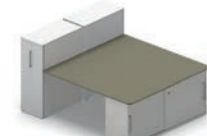
Patas: barnizadas epoxi blanco / **Sobre + puertas armarios:** roble natural / **Pantalla + cajoneras + archivador vertical:** melamina blanco

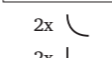

Alcuni esempi di possibili configurazioni - Some examples of possible layouts - Voici quelques exemples de configurations possibles - Einige Beispiele von möglichen Konfigurationen - Een aantal voorbeelden van mogelijke configuraties - Algunos ejemplos de configuraciones posibles

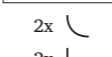
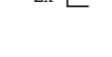
Per una più completa visione della collezione, consultare il listino
 Pour un meilleur aperçu de la collection, veuillez consulter la liste des prix
 Om de volledige collectie te raadplegen, zie de lijst

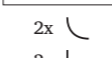
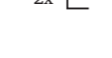
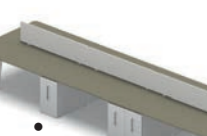
To view the collection in more detail, Please refer to our price list
 Eine komplette Ansicht der Kollektion finden Sie in der Preisliste
 Para ver más detalladamente la colección, consultar la tarifa

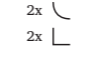
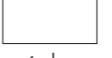
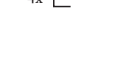
		cm	inch	angle
 <p>• CM.0408.ED/ES</p>	<p>Bench con 2 vertical File Bench with 2 vertical Files Bench avec 2 classeurs verticaux Bench mit 2 Vertical File Bench met 2 hangmappen Bench con 2 archivadores verticales</p>	L. 180 ÷ 240 P. 164 H. 72	L. 70¾" ÷ 94½" P. 64½" H. 28¼"	 2x  2x 
 <p>○ UBI UE.8040.00 • CM.0408.ED/ES</p>	<p>Bench con 2 UBI con top e 2 vertical File Bench with 2 UBI with top and 2 vertical File Bench avec 2 UBI avec top et 2 classeurs verticaux Bench mit 2 UBI mit Abdeckplatte, 2 Vertical File Bench met 2 ubi met top en 2 hangmappen Bench con 2 UBI con sobre y 2 archivadores verticales</p>	L. 180 ÷ 280 P. 164 H. 72	L. 70¾" ÷ 110¼" P. 64½" H. 28¼"	 2x  2x 
 <p>○ CM.0408.M3 • KC.1607.SC</p>	<p>Bench con 2 cassettiere portanti e mobile con ante scorrevoli Bench with 2 drawer units, 1 sliding door cabinet Bench avec 2 caissons portants et meuble avec portes coulissantes Bench mit 2 Stützcontainern und Sideboard mit Schiebetüren Bench met 2 dragende ladenblokken en meubel met schuifdeuren Bench con 2 cajoneras portante y mueble con puerta corredera</p>	L. 180 ÷ 280 P. 164 H. 72	L. 70¾" ÷ 110¼" P. 64½" H. 28¼"	 2x  2x 
 <p>• KC.1607.SC</p>	<p>Bench con 2 vertical File con top e 1 mobile con ante scorrevoli Bench with 2 vertical Files with top and 1 sliding door cabinet Bench avec 2 classeurs verticaux avec dessus et et 1 meuble avec portes coulissantes Bench mit 2 Vertical File mit Abdeckplatte und 1 Sideboard mit Schiebetüren Bench met 2 hangmappen met top en 1 meubel met schuifdeuren Bench con 2 archivadores verticales con sobre y 1 mueble con puertas correderas</p>	L. 360 ÷ 480 P. 164 H. 72	L. 141¾" ÷ 189" P. 64½" H. 28¼"	 2x  2x 
 <p>• CM.0408.M3</p>	<p>Bench con 4 cassettiere portanti Bench with 4 drawer units Bench avec 4 caissons portants Bench mit 4 Stützcontainern Bench met 4 dragende ladenblokken Bench con 4 cajoneras portantes</p>	L. 360 ÷ 480 P. 164 H. 72	L. 141¾" ÷ 189" P. 64½" H. 28¼"	 2x  2x 
 <p>○ UE.8040.00 • CM.0408.ED/ES</p>	<p>Bench con 4 UBI con top e 4 vertical File Bench with 4 UBI with top and 4 vertical File Bench avec 4 UBI avec top et 4 classeurs verticaux Bench mit 4 UBI mit Top, 4 Vertical File Bench met 4 ubi met top en 4 hangmappen Bench con 4 UBI con sobre y 4 archivadores verticales</p>	L. 360 ÷ 480 P. 164 H. 72	L. 141¾" ÷ 189" P. 64½" H. 28¼"	 2x  2x 
 <p>• CM.0408.ED/ES</p>	<p>Bench con 6 vertical File, Schermo per scrivania Bench with 6 vertical Files, Screen for desk Bench avec 6 classeurs verticaux, Écran privatif pour bureau Bench mit 6 Vertical File, Sichtschutz Bench met 6 hangmappen, Bureau scherm Bench con 6 archivadores verticales, Pantalla para escritorio</p>	L. 540 ÷ 720 P. 164 H. 72	L. 212¾" ÷ 283¾" P. 64½" H. 28¼"	 2x  2x  4x 



Gambe: verniciate epox bianco/ Piano + ante armadio: rovere naturale / Schermo + cassettiere + vertical file + fianchi e top armadio: melaminico bianco

Legs: white painted epoxy resin / Top + closet doors: natural oak wood / Panel + drawers + vertical file + closet sides and top: white melamine wood

Pieds: peints époxy blanc / Dessus + Portes armoires: chêne naturel / Écran + caissons+ classeur vertical + côtés et dessus placard: mélaminé blanc

Beine: Pulverlackiert weiß / Tischplatte + Schranktüren: Eiche natur / Sichtschutz + Container + Vertical File + Seitenverkleidungen und Schrankabdeckungen: Melamin Weiß

Poten: gelakt epoxy wit / Blad + deuren kast: natuurlijk eiken / Scherm + ladenkasten +hangmappen + zijpanelen en top kast: wit melamine

Patas: barnizadas epoxi blanco / Sobre + puertas armarios: roble natural / Pantalla + cajoneras + archivador vertical + costados y techo armario: melamina blanco

Compositions elements & dimensions

06/07 08/09

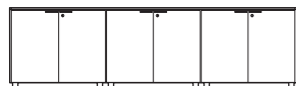

302,4 x 46 H.79,8 cm 119" x 18" H.31½"
Armadio mod. ABA
ABA Cabinet - Armoire ABA - Schränke ABA - Kasten ABA - Armario ABA



125,3 x 56,2 H.54 cm 49 ¼" x 22" H.21 ¼"
Mobile di servizio
Service Cabinet - Meuble de service - Sideboard - Serviceunit - Mueble de servicio

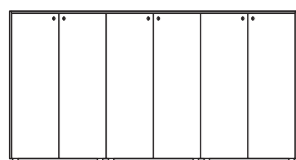

302,4 x 46 H.156,6 cm 119" x 18" H.61¾"
Armadio mod. ABA
ABA Cabinet - Armoire ABA - Schränke ABA - Kasten ABA - Armario ABA

10/11 12/13

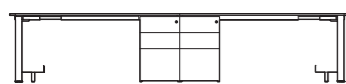

180 x 80 H.72 cm 70¾" x 31½" H.28¼"
N.02 scrivanie con cassette portante
N.02 Desks with support pedestal - N.02 Bureaux avec caisson portant - N.02 Schreibtische mit Container - N.02 Bureaus met ladenblok - N.02 Escritorios con cajonera de sustentación



240 x 40 H.103 cm 94½" x 15¾" H.40½"
Contentori mod. UBI EVO
UBI EVO Containers - Cubes UBI EVO - Container UBI EVO - Containers UBI EVO - Contenedores UBI EVO

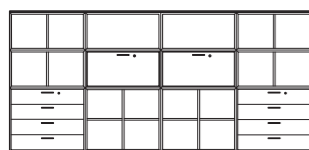

320 x 40 H.151 cm 126" x 15¾" H.59½"
Contentori mod. UBI EVO
UBI EVO Containers - Cubes UBI EVO - Container UBI EVO - Containers UBI EVO - Contenedores UBI EVO



Ø118 H.72 cm Ø46½" H.28¼"
Tavolo riunione rotondo
Round meeting table - Table ronde de réunion - Runder Konferenztisch - Ronde vergadertafel - Mesa redonda de reunión



200 x 80 H.72 cm 78¾" x 31½" H.28¼"
Scrivania
Desk - Bureau - Schreibtisch - Bureau - Escritorio
160 x 1,8 H.38 cm 63" x ¾" H.15"
Modesty panel
Modesty panel - Voiles de fond - Knieraublendenn - Frontpaneel - Panel frontal

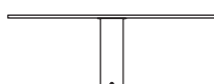

220 x 124 H.75 cm 86¾" x 48¾" H.29½"
Tavolo sagomato con colonna base
Shaped table with column and base - Table elliptique avec colonne et base - Tisch geformt mit Säule und Bodenplatte - Gevormde tafel met kolom en basis - Mesa ovalada con columna y base

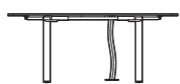

180 x 164 H.72 cm 70¾" x 64½" H.28¼"
Tavolo riunione
Meeting table - Table de réunion - Konferenztisch - Vergadertafel - Mesa de reunión

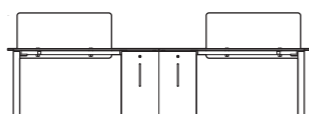

160 x 80 H.72 cm 63" x 31½" H.28¼"
N.02 Scrivanie con Vertical file basso
N.02 Desks with Vertical file - N.02 Bureaux avec classeur vertical - N.02 Schreibtische mit Vertical File - N.02 Bureaus met hangmappen - N.02 Escritorios con Vertical file
100 x 1,8 H.48 cm 39¼" x ¾" H.18¾"
Schermo divisorio
High screen - Écran haut - Hoher Sichtschutz - Hoog scherm - Pantalla alta

Per una più completa visione della collezione, consultare il listino
Pour une vue plus complète de la collection, voir la liste des prix
Voor een compleet overzicht van de collectie, zie de prijslijst

For a more complete view of the collection, see the price list
Für eine vollständige Ansicht der Sammlung finden Sie in der Preisliste
Para una visión más completa de la colección, consulte la lista de precios

16/17 18/19 20/21

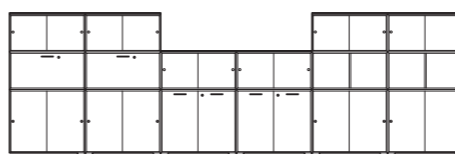

482 x 40 H.151 cm 189¾" x 15¾" H.59½"
Contentori mod. UBI EVO
UBI EVO Containers - Cubes UBI EVO - Container UBI EVO - Containers UBI EVO - Contenedores UBI EVO

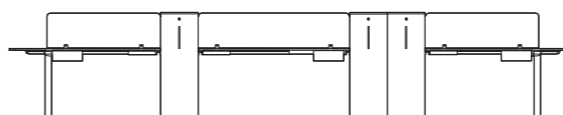

600 x 164 H.73/110 cm 236¼" x 64½" H.28¾"/43¼"
Composizione Bench
Bench composition - Poste de travail - Bench-Arbeitsplatz - Samenstelling bench - Composición bench

120/160 x 1,8 H.38 cm 47¼"/63" x ¾" H.15"
Schermo divisorio
High screen - Écran haut - Hoher Sichtschutz - Hoog scherm - Pantalla alta

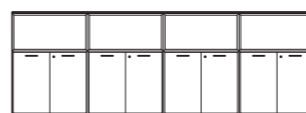

321 x 40 H.111 cm 126¼" x 15¾" H.43¾"
Contentori mod. UBI EVO
UBI EVO Containers - Cubes UBI EVO - Container UBI EVO - Containers UBI EVO - Contenedores UBI EVO

24/25 27

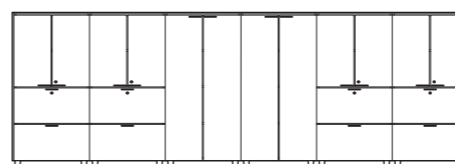

402,4 x 46 H.156,6 cm 158½" x 18" H.61¾"
Armadio mod. ABA
ABA Cabinet - Armoire ABA - Schränke ABA - Kasten ABA - Armario ABA

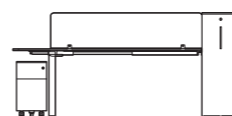

240 x 164 H.72/110 cm 94½" x 64½" H.28¼"/43¼"
Composizione Bench
Bench composition - Poste de travail - Bench-Arbeitsplatz - Samenstelling bench - Composición bench

140 x 1,8 H.38 cm 55¼" x ¾" H.15"
Schermo divisorio
High screen - Écran haut - Hoher Sichtschutz - Hoog scherm - Pantalla alta

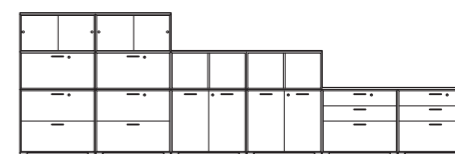

482 x 40 H.151 cm 189¾" x 15¾" H.59½"
Contentori mod. UBI EVO
UBI EVO Containers - Cubes UBI EVO - Container UBI EVO - Containers UBI EVO - Contenedores UBI EVO

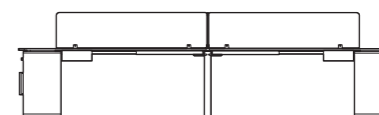

400 x 164 H.72 cm 157½" x 64½" H.28¼"
Composizione Bench
Bench composition - Poste de travail - Bench-Arbeitsplatz - Samenstelling bench - Composición bench

160 x 1,8 H.38 cm 63" x ¾" H.15"
Schermo divisorio
High screen - Écran haut - Hoher Sichtschutz - Hoog scherm - Pantalla alta

160 x 40 H.69 cm 63" x 15¾" H.27"
Mobile con ante scorrevoli
Cabinet with sliding doors - Meuble avec portes coulissantes - Möbel mit Schiebetüren - Meubel met schuifdeuren - Mueble con puertas correderas

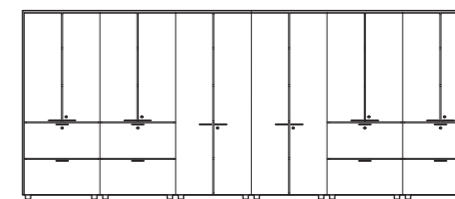

402,4 x 46 H.195 cm 158½" x 18" H.76¾"
Armadio mod. ABA
ABA Cabinet - Armoire ABA - Schränke ABA - Kasten ABA - Armario ABA

take off
evolution

country



take off evolution country



Rivestimento gambe + frontali e top cassettiere: melaminico rovere antico / Piani + Ubi: melaminico bianco / Schermi: a sinistra tessuto Xpress - Blue jeans, sopra tessuto Lucia - Blu Martinique

Leg coating + drawer front panels and tops: decapé oak melamine wood / Tops + Ubi: white melamine wood / Panels: left Xpress - Blue Jeans fabric, above Lucia - Blue Martinique fabric

Revêtement pieds + façades et dessus caissons: mélaminé chêne antique / Plateaux + Ubi: mélaminé blanc / Écrans: gauche revêtement tissu Xpress - Blue jeans, revêtement tissu Lucia - Bleu Martinique

Beinverkleidung + Fronten und Containerabdeckung: Melamin Eiche antik / Tischplatten + Ubi: Melamin Weiß / Sichtschutz: links Stoff Xpress - Blue Jeans, oben Stoff Lucia - Blu Martinique





























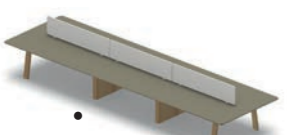



Bekleding poten + voorpanelen en top ladekasten: verouderd eiken melamine / Bladen + Ubi: wit melamine / Schermen: links stof Xpress - Blue jeans, boven stof Lucia - blauw Martinique

Revestimiento patas + frentes y encimeras cajoneras: melamina roble vintage / Sobres + Ubi: melamina blanco / Pantallas: izquierda tejido Xpress - Blue jeans, encima tejido Lucia - Blu Martinique

Alcuni esempi di possibili configurazioni - Some examples of possible layouts - Voici quelques exemples de configurations possibles - Einige Beispiele von möglichen Konfigurationen - Een aantal voorbeelden van mogelijke configuraties - Algunos ejemplos de configuraciones posibles

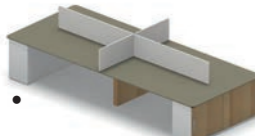
Per una più completa visione della collezione, consultare il listino
 Pour un meilleur aperçu de la collection, veuillez consulter la liste des prix
 Om de volledige collectie te raadplegen, zie de lijst

To view the collection in more detail, Please refer to our price list
 Eine komplette Ansicht der Kollektion finden Sie in der Preisliste
 Para ver más detalladamente la colección, consultar la tarifa

		cm	inch	angle
 32/33	 35			
	Bench con gambe rivestite Bench with coated legs Bench avec pieds revêtus Bench mit verkleideten Beinen Bench met beklede poten Bench con patas revestidas	L. 160 ÷ 240 P. 164 H. 72	L. 63" ÷ 94½" P. 64½" H. 28¼"	 2x  2x 
	Bench con gambe rivestite con 2 cassettiere portanti Bench with coated legs with 2 drawer units Bench avec pieds revêtus avec 2 caissons portants Bench mit verkleideten Beinen mit 2 Stützcontainern Bench met beklede poten met 2 dragende ladenblokken Bench con patas revestidas con 2 cajoneras portantes	L. 180 ÷ 240 P. 164 H. 72	L. 70¾" ÷ 94½" P. 64½" H. 28¼"	 2x  2x 
	Bench con gambe rivestite con 2 vertical File Bench with coated legs with 2 vertical Files Bench avec pieds revêtus avec 2 classeurs verticaux Bench mit verkleideten Beinen mit 2 Vertical File Bench met beklede poten met 2 hangmappen Bench con patas revestidas con 2 archivadores verticales	L. 180 ÷ 240 P. 164 H. 72	L. 70¾" ÷ 94½" P. 64½" H. 28¼"	 2x  2x 
	Bench con gambe rivestite e 1 mobile con ante scorrevoli Bench with coated legs and 1 sliding door cabinet Bench avec pieds revêtus et 1 meuble avec vantaux coulissants Bench mit verkleideten Beinen und 1 Möbel mit Schiebetüren Bench met beklede poten en 1 meubel met schuifdeuren Bench con patas revestidas y 1 mueble con puertas correderas	L. 160 ÷ 240 P. 164 H. 72	L. 63" ÷ 94½" P. 64½" H. 28¼"	 2x  2x 
	Bench con gambe rivestite con gamba intermedia con pannello di tamponamento, Schermo per scrivania Bench with coated legs with middle leg with infill panel, Screen for desk Bench avec pieds revêtus avec pied intermédiaire avec panneaux de fermeture, Ecran privatif pour bureau Bench mit verkleideten Beinen mit Zwischenbein, Verkleidungspaneel, Sichtschutz Bench met beklede poten met tussenpoot met tussenpaneel, Bureauscherm Bench con patas revestidas con pata intermedia con tablero compensación, Pantalla para escritorio	L. 540 ÷ 720 P. 164 H. 72	L. 212¾" ÷ 283¾" P. 64½" H. 28¼"	 2x  2x  4x 
	Bench con gambe rivestite con 6 cassettiere portanti, Schermo per scrivania Bench with coated legs with 6 drawer units, Screen for desk Bench avec pieds revêtus avec 6 caissons portants, Ecran privatif pour bureau Bench mit verkleideten Beinen mit 6 Stützcontainern, Sichtschutz Bench met beklede poten met 6 ladenblokken, Bureauscherm Bench con patas revestidas con 6 cajoneras portantes, Pantalla para escritorio	L. 540 ÷ 720 P. 164 H. 72	L. 212¾" ÷ 283¾" P. 64½" H. 28¼"	 2x  2x  4x 
	Bench con gambe rivestite e 2 mobili con ante scorrevoli, Schermo per scrivania Bench with coated legs and 2 sliding door cabinet, Screen for desk Bench avec pieds revêtus et 2 meuble avec vantaux coulissants, Ecran privatif pour bureau Bench mit verkleideten Beinen und 2 Sideboards mit Schiebetüren, Sichtschutz Bench met beklede poten en 2 meubel met schuifdeuren, Bureauscherm Bench con patas revestidas y 2 mueble con puertas correderas, Pantalla para escritorio	L. 540 ÷ 720 P. 164 H. 72	L. 212¾" ÷ 283¾" P. 64½" H. 28¼"	 2x  2x 



Rivestimento gambe + frontali vertical file: melaminico rovere antico / Piani + Ubi: melaminico bianco / Schermi: sopra tessuto Xpress - Verde sottobosco, a destra tessuto Lucia - Petrolio Windjammer

Legs + vertical file front panels and tops: rustic oak melamine wood / Tops: white melamine wood / Panels: above Xpress - Green Underbush fabric, right Lucia - Petroleum Windjammer fabric

Pieds + façades classeur vertical: mélaminé chêne antique / Plateau: mélaminé blanc / Écrans: revêtement tissu Xpress - Vert sous-bois, droite tissu Lucia - Pétrole-Windjammer

Beine + Fronten Vertical File: Melamin Eiche antik / Tischplatten: Melamin Weiß / Sichtschutz: oben Stoff Xpress - Unterholz-Grün, rechts Stoff Lucia - Petroleum Blau Windjammer

Poten + voorpanelen hangmappen: verouderd eiken melamine / Bladen: wit melamine / Schermen: boven stof Xpress - bosgrondgroen, rechts stof Lucia - Petroleum Windjammer

Patas + frentes archivador vertical: melamina roble vintage / Sobres: melamina blanco / Pantallas: encima tejido Xpress - Verde sotobosque, derecho tejido Lucia - Petróleo-Windjammer



take off

evolution **country**

Rivestimento gambe: melaminico rovere anticato /
 Porta cpu: verniciato epox nero / Piani + Ubi: melami-
 nico bianco / Mobili EKO + frontali Ubi: melaminico
 nebbia / Schermo: laccato tortora

Beineverkleidung: Melamin Eiche Antik / CPU Halter:
 EPOX-lackiert Schwarz / Tischplatten: Melamin Weiß
 / Möbel EKO + Fassaden Ubi: Melamin Nebelgrau /
 Schirmwand: lackiert Taubengrau / Ubi: Melamin Weiß

Leg coating: decapé oak melamine wood / CPU holder:
 black painted epoxy resin / Tops: white melamine wood
 / EKO furniture + Ubi front panels: fog coloured melamine
 wood / Panel: light grey lacquered wood / Ubi: white
 melamine wood

Bekleding poten: verouderd eiken melamine / CPU-hou-
 der: gelakt epoxy zwart / Bladen: wit melamine /
 Meubels EKO + voorpanelen Ubi: mistkleurig melamine /
 Scherm: gelakt duifgrijs / Ubi: wit melamine

Revêtement pieds: mélaminé chêne antique / Porte-CPU :
 peint époxy noir / Dessus: mélaminé blanc / Meubles
 EKO + façades Ubi: mélaminé brouillard / Écran: laqué
 tourterelle / Ubi: mélaminé blanc

Revestimiento patas: melamina roble vintage / Soporte
 para cpu: barnizado epoxi negro / Sobres: melamina
 blanco / Muebles EKO + frentes Ubi: melamina niebla /
 Pantalla: lacado gris ceniciento / Ubi: melamina blanco



take off

evolution **country**



Rivestimento gambe: melaminico rovere anticato / **Piani:** melaminico bianco e melaminico nebbia / **Porta cpu:** verniciato epox nero / **Mobili EKO:** melaminico nebbia / **Ubi:** melaminico bianco / **Frontali e ante Ubi:** melaminico nebbia

Leg coating: Clad oak melamine wood / Top: white melamine wood and fog coloured melamine wood / CPU holder: black painted epoxy resin / EKO furniture: fog coloured melamine wood / Ubi: white melamine wood / Ubi front panels and doors: fog coloured melamine wood

Revêtement pieds: mélaminé chêne antique / Dessus: mélaminé blanc et mélaminé brouillard / Porte-CPU: peint époxy noir / Meubles EKO: mélaminé brouillard / Ubi: mélaminé blanc / Façades Ubi: mélaminé brouillard

Beinverkleidung: Melamin Eiche antik / Tischplatte: Melamin Weiß, Melamin Nebelgrau / Computerträger: Pulverlackiert Schwarz / Sideboard EKO: Melamin Nebelgrau / Ubi: Melamin Weiß / Fronten und Türen Ubi: Melamin Nebelgrau













Bekleding poten: verouderd eiken melamine / Blad: wit melamine, mistkleurig melamine / CPU-houder: gelakt epoxy zwart / Meubels EKO: mistkleurig melamine / Ubi: wit melamine / Voorpanelen en deuren Ubi: mistkleurig melamine

Revestimiento patas: melamina roble vintage / Sobre: melamina blanco, melamina niebla / Soporte para cpu: barnizado epoxi negro / Muebles EKO: melamina niebla / Ubi: melamina blanco / Frentes y puertas Ubi: melamina niebla

Alcuni esempi di possibili configurazioni - Some examples of possible layouts - Voici quelques exemples de configurations possibles - Einige Beispiele von möglichen Konfigurationen - Een aantal voorbeelden van mogelijke configuraties - Algunos ejemplos de configuraciones posibles

Per una più completa visione della collezione, consultare il listino
 Pour un meilleur aperçu de la collection, veuillez consulter la liste des prix
 Om de volledige collectie te raadplegen, zie de lijst

To view the collection in more detail, Please refer to our price list
 Eine komplette Ansicht der Kollektion finden Sie in der Preisliste
 Para ver más detalladamente la colección, consultar la tarifa

	cm	inch	angle
 <p>Scrivania con gambe rivestite Desk with coated legs Bureau avec pieds revêtus Schreibtisch mit verkleideten Beinen Bureau met beklede poten Escritorio con patas revestidas</p>	L. 160÷240 P. 100 H. 72	L. 63" ÷ 94½" P. 39¼" H. 28¼"	4x 
 <p>Scrivania con gambe rivestite Desk with coated legs Bureau avec pieds revêtus Schreibtisch mit verkleideten Beinen Bureau met beklede poten Escritorio con patas revestidas</p>	L. 160÷240 P. 100 H. 72	L. 63" ÷ 94½" P. 39¼" H. 28¼"	2x  2x 
 <p>Scrivania con gambe rivestite Desk with coated legs Bureau avec pieds revêtus Schreibtisch mit verkleideten Beinen Bureau met beklede poten Escritorio con patas revestidas</p>	L. 160÷240 P. 100 H. 72	L. 63" ÷ 94½" P. 39¼" H. 28¼"	2x  2x 
 <p>Scrivania con gambe rivestite + Schermo per scrivania Desk with coated legs + Screen for desk Bureau avec pieds revêtus + Ecran privatif pour bureau Schreibtisch mit verkleideten Beinen + Sichtschutz Bureau met beklede poten + Bureauscherm Escritorio con patas revestidas + Pantalla para escritorio</p>	L. 160÷240 P. 100 H. 72	L. 63" ÷ 94½" P. 39¼" H. 28¼"	4x 
 <p>Scrivania con gambe rivestite + Schermo per scrivania Desk with coated legs + Screen for desk Bureau avec pieds revêtus + Ecran privatif pour bureau Schreibtisch mit verkleideten Beinen + Sichtschutz Bureau met beklede poten + Bureauscherm Escritorio con patas revestidas + Pantalla para escritorio</p>	L. 160÷240 P. 100 H. 72	L. 63" ÷ 94½" P. 39¼" H. 28¼"	4x 



Rivestimento gambe: melaminico rovere antico / Porta cpu: verniciato epox nero / Piani + mobile EKO: melaminico nero / Ante Ubi + frontale vertical file+ schermo: melaminico tortora

Leg coating: decapé oak melamine wood / CPU holder: black painted epoxy resin / Tops + EKO cabinet: black melamine wood / Ubi doors + vertical file front panel + panel: light grey melamine wood

Revêtement pieds: mélaminé chêne antique / Porte-CPU: peint époxy noir / Dessus + meuble EKO: mélamine noir / Façades Ubi + façades classeur vertical + Écran: mélaminé tourterelle

Beinverkleidung: Melamin Eiche antik / Tischplatten + Sideboard EKO: Melamin Schwarz / Türen Ubi + Front Vertical File + Sichtschutz: Melamin Taubengrau

Bekleding poten: verouderd eiken melamine / CPU-houder: gelakt epoxy zwart / Bladen + meubel EKO: zwart melamine / Deuren Ubi + voorpaneel hangmappen + Scherm: duifgrijs melamine

Revestimiento patas: melamina roble vintage / Soporte para cpu: barnizado epoxi negro / Sobres + mueble EKO: melamina negro / Puertas Ubi + frente archivador vertical + pantalla: melamina gris ceniciento



Rivestimento gambe: melaminico rovere antico / Piano: melaminico bianco / Mobili EKO: melaminico nebbia / Schermo: tessuto Lucia - Sabbia Aruba

Leg coating: decapé oak melamine wood / Top: white melamine wood / EKO furniture: fog coloured melamine wood / Panel: Lucia - Aruba Sand fabric

Revêtement pieds: mélaminé chêne antique / Dessus: melamine blanc / Meubles EKO: melamine brouillard / Écran: tissu Lucia - Sable Aruba

Beinverkleidung: Melamin Eiche antik / Tischplatte: Melamin Weiß / Sideboard EKO: Melamin Nebelgrau / Sichtschutz: Stoff Lucia - Sandfarbe Aruba

Bekleding poten: verouderd eiken melamine / Blad: wit melamine / Meubels EKO: mistkleurig melamine / Scherm: stof Lucia - Zand Aruba

Revestimiento patas: melamina roble vintage / Sobre: melamina blanco / Muebles EKO: melamina niebla / Pantalla: tejido Lucia - Arena Aruba

take off evolution **country**

Rivestimento gambe: melaminico rovere anticato /
Piano: melaminico bianco

Beinverkleidung: Melamin Eiche antik / Tischplatte:
Melamin Weiß

Leg coating: decapé oak melamine wood / Top: white
melamine wood

Bekleding poten: verouderd eiken melamine / Blad: wit
melamine

Revêtement pieds: mélaminé chêne antique / Plateau:
mélaminé blanc

Revestimiento patas: melamina roble vintage / Sobre:
melamina blanco













Alcuni esempi di possibili configurazioni - Some examples of possible layouts - Voici quelques exemples de configurations possibles - Einige Beispiele von möglichen Konfigurationen - Een aantal voorbeelden van mogelijke configuraties - Algunos ejemplos de configuraciones posibles

take off evolution country

Per una più completa visione della collezione, consultare il listino
Pour un meilleur aperçu de la collection, veuillez consulter la liste des prix
Om de volledige collectie te raadplegen, zie de lijst

To view the collection in more detail, Please refer to our price list
Eine komplette Ansicht der Kollektion finden Sie in der Preisliste
Para ver más detalladamente la colección, consultar la tarifa

42/43 45		cm	inch	angle
	Tavolino con gambe rivestite Small table with coated legs Petite table avec pieds revêtus Kleiner Tisch mit verkleideten Beinen Tafeltje met beklede poten Mesita con patas revestidas	L. 60 P. 60 H. 43	L. 23¾" P. 23¾" H. 17"	4x 
	Tavolino con gambe rivestite Small table with coated legs Petite table avec pieds revêtus Kleiner Tisch mit verkleideten Beinen Tafeltje met beklede poten Mesita con patas revestidas	L. 120 P. 60 H. 43	L. 47¼" P. 23¾" H. 17"	4x 
	Tavolo con gambe rivestite con 1 top access Table with coated legs with 1 top access Table avec pieds revêtus avec 1 top access Tisch mit verkleideten Beinen mit 1 Top Access Tafel met beklede poten met 1 toegang Mesita con patas revestidas con 1 acceso superior	L. 180 ÷ 200 P. 100 H. 72	L. 70¾" ÷ 78¾" P. 39¼" H. 28¼"	4x 
	Tavolo con gambe rivestite con 2 top access Table with coated legs with 2 top accesses Table avec pieds revêtus avec 2 tops access Tisch mit verkleideten Beinen mit 2 Top Access Tafel met beklede poten met 2 toegangen Mesita con patas revestidas con 2 accesos superiores	L. 220 ÷ 240 P. 100 H. 72	L. 86¾" ÷ 94½" P. 39¼" H. 28¼"	4x 
	Tavolo con gambe rivestite con 1 top access Table with coated legs with 1 top access Table avec pieds revêtus avec 1 top access Tisch mit verkleideten Beinen mit 1 Top Access Tafel met beklede poten met 1 toegang Mesita con patas revestidas con 1 acceso superior	L. 180 ÷ 200 P. 124 - 164 H. 72	L. 70¾" ÷ 78¾" P. 48¾" - 64½" H. 28¼"	4x 
	Tavolo con gambe rivestite con gamba intermedia con pannello di tamponamento e top access Table with Clad legs middle leg with infill panel and top access Table avec pieds revêtus avec pied intermédiaire avec panneaux de fermeture et top access Tisch mit verkleideten Beinen mit Zwischenbein, Verkleidungspaneel, Top Access Tafel met beklede poten met tussenpoot met tussenpaneel en toegang Mesita con patas revestidas con pata intermedia con tablero compensación y acceso superior	L. 320 ÷ 480 P. 124 - 164 H. 72	L. 126" ÷ 189" P. 48¾" - 64½" H. 28¼"	4x 



Rivestimento gambe: melaminico rovere antico /
Piano: melaminico bianco

Beinverkleidung: Melamin Eiche antik / Tischplatte:
Melamin Weiß

Leg coating: Clad oak melamine wood / Top: white
melamine wood

Bekleding poten: verouderd eiken melamine / Blad: wit
melamine

Revêtement pieds: mélaminé chêne antique / Plateau:
mélaminé blanc

Revestimiento patas: melamina roble vintage / Sobre:
melamina blanco

Compositions elements & dimensions

32/33 35

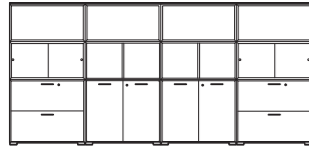

320 x 40 H.151 cm 126" x 15¾" H.59½"
Contenitori mod. UBI EVO
UBI EVO Containers - Cubes UBI EVO - Container UBI EVO - Containers UBI EVO -
Contenedores UBI EVO

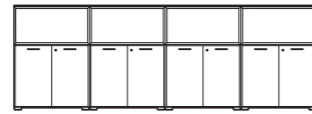

321 x 40 H.111 cm 126¼" x 15¾" H.43¾"
Contenitori mod. UBI EVO
UBI EVO Containers - Cubes UBI EVO - Container UBI EVO - Containers UBI EVO -
Contenedores UBI EVO

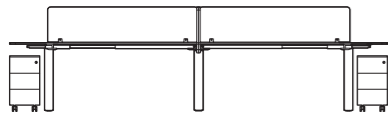

400 x 164 H.72/110 cm 157½" x 64½" H.28¼"/43¼"
Composizione Bench
Bench composition - Poste de travail - Bench-Arbeitsplatz - Samenstelling bench -
Composición bench

31,8 x 56,3 H.58,7 cm 12½" x 22" H.23"
Cassettiera Slim
Pedestal Slim - Caisson Slim - Slim Container - Ladenblok Slim - Cajonera Slim

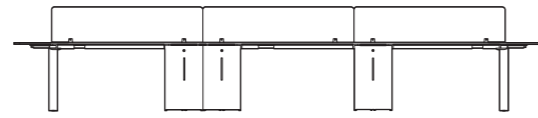

560 x 164 H.72/110 cm 220½" x 64½" H.28¼"/43¼"
Composizione Bench
Bench composition - Poste de travail - Bench-Arbeitsplatz - Samenstelling bench -
Composición bench

160 x 1,8 H.38 cm 63" x ¾" H.15"
Schermo divisorio
High screen - Écran haut - Hoher Sichtschutz - Hoog scherm - Pantalla alta

36/37 38/39 41

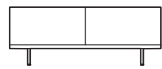

160 x 40 H.62 cm 63" x 15¾" H.24½"
Contenitori mod. UBI EVO
UBI EVO Containers - Cubes UBI EVO - Container UBI EVO - Containers UBI EVO -
Contenedores UBI EVO



125,3 x 56,2 H.54 cm 49 ¼" x 22" H.21 ¼"
Mobile di servizio
Service Cabinet - Meuble de service - Sideboard - Serviceunit - Mueble de servicio



321 x 40 H.151 cm 126¼" x 15¾" H.59½"
Contenitori mod. UBI EVO
UBI EVO Containers - Cubes UBI EVO - Container UBI EVO - Containers UBI EVO -
Contenedores UBI EVO



321 x 40 H.62 cm 126¼" x 15¾" H.24½"
Contenitori mod. UBI EVO
UBI EVO Containers - Cubes UBI EVO - Container UBI EVO - Containers UBI EVO -
Contenedores UBI EVO

Per una più completa visione della collezione, consultare il listino
Pour une vue plus complète de la collection, voir la liste des prix
Voor een compleet overzicht van de collectie, zie de prijslijst

For a more complete view of the collection, see the price list
Für eine vollständigere Ansicht der Sammlung finden Sie in der Preisliste
Para una visión más completa de la colección, consulte la lista de precios

36/37 38/39 40



220 x 100 H.72 cm 86¾" x 39¼" H.28¼"
Scrivania
Desk - Bureau - Schreibtische - Bureau - Escritorio

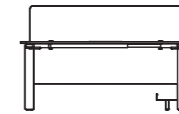

180 x 100 H.72 cm 70¾" x 39¼" H.28¼"
Scrivania
Desk - Bureau - Schreibtische - Bureau - Escritorio

160 x 1,8 H.82 cm 63" x ¾" H.32¼"
Schermo divisorio
High screen - Écran haut - Hoher Sichtschutz - Hoog scherm - Pantalla alta

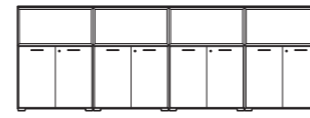

321 x 40 H.111 cm 126¼" x 15¾" H.43¾"
Contenitori mod. UBI EVO
UBI EVO Containers - Cubes UBI EVO - Container UBI EVO - Containers UBI EVO -
Contenedores UBI EVO

42/43 45



320 x 124 H.72 cm 126" x 48¾" H.28¼"
Tavolo riunione rettangolare
Rectangular meeting table - Table rectangulaire de réunion - Rechteckiger Konferenztisch
- Rechthoekige vergadertafel - Mesa rectangular de reunión



Ø160 H.72 cm Ø63" H.28¼"
Tavolo riunione rotondo
Round meeting table - Table ronde de réunion - Runder Konferenztisch -
Ronde vergadertafel - Mesa redonda de reunión

take off
evolution

farm



take off evolution farm

Rivestimento gambe: melaminico rovere anticato
/ Piani + mensole: melaminico rovere anticato /
Schermo: vetro temperato grigio / Passacavi: tessuto
Puma - Nero

Beinverkleidung: Melamin Eiche antik / Tischplatte + Kon-
solen: Melamin Eiche antik / Sichtschutz: gehärtetes Glas
Grau / Kabeldurchlass: Stoff Puma - Schwarz

Leg coating: Clad oak melamine wood / Tops + shelves:
decapé oak melamine wood / Panel: grey tempered glass
/ Cable holder: Puma - Black fabric

Bekleding poten: verouderd eiken melamine / Bladen +
legplanken: verouderd eiken melamine / Scherm: grijs
gehard glas / Kabeldoorvoer: stof Poema - Zwart

Revêtement pieds: mélaminé chêne antique / Plateau +
étagères: mélaminé chêne antique / Écran: verre trempé
gris / Passe-câbles: tissu Puma - Noir

Revestimiento patas: melamina roble vintage / Sobres
+ ménsulas: melamina roble vintage / Pantalla: cristal
templado gris / Pasacables: tejido Puma - Negro



take off evolution farm



Rivestimento gambe + piano: melaminico rovere anticato / Scocche cassettiere: melaminico nero / Frontali e top cassettiere: melaminico rovere anticato / Schermo: vetro temperato grigio

Leg coating + top: oak melamine wood / Drawer shell: black melamine wood / Drawer front panels and tops: Rustic oak melamine wood / Panel: grey tempered glass

Revêtement pieds + plateau: mélaminé chêne antique / Châssis caissons: mélaminé noir / Façades et dessus caissons: mélaminé chêne antique / Écran: verre trempé gris

Beinverkleidung + Tischplatte: Melamin Eiche antik / Container-Korpus: Melamin Schwarz / Fronten und Container-abdeckung: Melamin Eiche antik / Sichtschutz: gehärtetes Glas Grau

Bekleding poten + blad: verouderd eiken melamine / Wandpanelen ladekasten: zwart melamine / Voorpanelen en top ladekasten: verouderd eiken melamine / Scherm: grijs gehard glas

Revestimiento patas + sobre: melamina roble vintage / Armazones cajoneras: melamina negro / Frontes y encimeras cajoneras: melamina roble vintage / Pantalla: cristal templado gris

take off evolution farm

Rivestimento gambe + piano: melaminico rovere antico / Ante, fianchi e top armadio: melaminico nero

Beinverkleidung + Platte: Melamin Eiche antik / Türen, Seitenverkleidungen und Schrankoberplatte: Melamin Schwarz

Leg coating + top: Rustic oak melamine wood / Closet sides, doors and top: black melamine wood

Bekleding poten + blad: verouderd eiken melamine / Deuren, zijpanelen en top kast: zwart melamine

Revêtement pieds + plateau: mélaminé chêne antique / Façades, côtés et dessus placard: mélaminé noir

Revestimiento patas + sobre: melamina roble vintage / Puertas, costados y techo armario: melamina negro





Rivestimento gambe + piano: melaminico rovere anticato / Ante, fianchi e top armadio: melaminico rovere anticato

Beinverkleidung + Tischplatte: Melamin Eiche antik / Türen, Seitenverkleidungen und Schrankoberplatte: Melamin Eiche antik

Leg coating + top: decapé oak melamine wood / Closet sides, doors and top: decapé oak melamine wood

Revêtement pieds + plateaux: mélaminé chêne antique / Façades, côtés et dessus placard: mélaminé chêne antique

Bekleding poten + blad: verouderd eiken melamine / Deuren, zijpanelen en top kast: verouderd eiken melamine

Revestimiento patas + sobre: melamina roble vintage / Puertas, costados y techo armario: melamina roble vintage

Rivestimento gambe + piano: melaminico rovere anticato / Ante, fianchi e top armadio: melaminico bianco

Leg coating + top: decapé oak melamine wood / Closet sides, doors and top: white melamine wood

Revêtement pieds + plateaux: mélaminé chêne antique / Façades, côtés et dessus placard: mélaminé blanc

Beinverkleidung + Tischplatte: Melamin Eiche antik / Türen, Seitenverkleidungen und Schrankoberplatte: Melamin Weiß

Bekleding poten + blad: verouderd eiken melamine / Deuren, zijpanelen en top kast: wit melamine

Revestimiento patas + sobre: melamina roble vintage / Puertas, costados y techo armario: melamina blanco



Alcuni esempi di possibili configurazioni - Some examples of possible layouts - Voici quelques exemples de configurations possibles - Einige Beispiele von möglichen Konfigurationen - Een aantal voorbeelden van mogelijke configuraties - Algunos ejemplos de configuraciones posibles

Per una più completa visione della collezione, consultare il listino
 Pour un meilleur aperçu de la collection, veuillez consulter la liste des prix
 Om de volledige collectie te raadplegen, zie de lijst

To view the collection in more detail, Please refer to our price list
 Eine komplette Ansicht der Kollektion finden Sie in der Preisliste
 Para ver más detalladamente la colección, consultar la tarifa

		cm	inch	angle
<p>54/55 56</p> <p>• CM.0407.M4</p>	<p>Scrivania con gambe rivestite, Dattilo appeso con cassetiera portante Desk with coated legs, Workwall legs with drawer unit Bureau avec pieds revêtus, Dactylo suspendu avec caisson portant Schreibtisch mit verkleideten Beinen, Andocktisch mit Stützcontainer Bureau met beklede poten, Oplegtafel met dragende ladenblok Escritorio con patas revestidas, Ala escritorio suspendido con cajonera portante</p>	L. 160 ÷ 200 P. 180 - 200 H. 73	L. 63" ÷ 78¾" P. 70¾" - 78¾" H. 28¾"	<p>4x</p>
	<p>Bench con gambe rivestite Bench with coated legs Bench avec pieds revêtus Bench mit verkleideten Beinen Bench met beklede poten Bench con patas revestidas</p>	L. 136 ÷ 240 P. 124 - 164 H. 73	L. 53½" ÷ 94½" P. 48¾" - 64½" H. 28¾"	<p>4x</p>
	<p>Bench con gambe rivestite Bench with coated legs Bench avec pieds revêtus Bench mit verkleideten Beinen Bench met beklede poten Bench con patas revestidas</p>	L. 180 ÷ 276 P. 124 - 164 H. 73	L. 70¾" ÷ 108¾" P. 48¾" - 64½" H. 28¾"	<p>4x</p>
	<p>Bench con gambe rivestite e 2 top access Bench with coated legs and base and 2 top access Bench avec pieds revêtus et base et 2 top access Bench mit verkleideten Beinen und 2 Top Access Bench met beklede poten en 2 toegangen Bench con patas revestidas y 2 acceso superior</p>	L. 180 ÷ 276 P. 124 - 164 H. 73	L. 70¾" ÷ 108¾" P. 48¾" - 64½" H. 28¾"	<p>4x</p>
<p>• CM.0408.ED/ES</p>	<p>Bench con gambe rivestite con 2 vertical File Bench with coated legs with 2 vertical File Bench avec pieds revêtus avec 2 classeurs verticaux Bench mit verkleideten Beinen mit 2 Vertical File Bench met beklede poten met 2 hangmappen Bench con patas revestidas con 2 archivadores verticales</p>	L. 180 ÷ 240 P. 164 H. 73	L. 70¾" ÷ 94½" P. 64½" H. 28¾"	<p>4x</p>
	<p>Tavolo con gambe rivestite Table with coated legs Table avec pieds revêtus Tisch mit verkleideten Beinen Tafel met beklede poten Mesita con patas revestidas</p>	L. 220 ÷ 276 P. 100 H. 73	L. 86¾" ÷ 108¾" P. 39¾" H. 28¾"	<p>4x</p>
	<p>Tavolo sagomato con colonna e base e 1 top access Shaped table with column and base and 1 top access Table elliptique avec colonne et base et 1 top access Tisch geformt mit Säule und Bodenplatte und 1 Top Access Gevormde tafel met kolom en basis en 1 toegang Mesa ovalada con columna y base y 1 acceso superior</p>	L. 220 P. 124 H. 73	L. 86¾" P. 48¾" H. 28¾"	

take off evolution farm

Rivestimento gambe + piano: melaminico rovere
anticato

Beinverkleidung + Tischplatte: Melamin Eiche antik

Leg coating + top: decapé oak melamine wood

Bekleding poten + blad: verouderd eiken melamine

Revêtement pieds + plateau: mélaminé chêne antique

Revestimiento patas + sobre: melamina roble vintage





Rivestimento gambe + piano: melaminico rovere anticato

Leg coating + top: decapé oak melamine wood

Revêtement pieds + plateau: mélaminé chêne antique

Beinverkleidung + Tischplatte: Melamin Eiche antik

Bekleding poten + blad: verouderd eiken melamine

Revestimiento patas + sobre: melamina roble vintage

Rivestimento gambe + piano: melaminico rovere anticato / Ante Ubi: laccato bordeaux, nebbia, tortora, titiano, verde natura, giallo gold, bianco

Leg coating + top: Rustic oak melamine wood / Ubi doors: burgundy, fog, light grey, nature green, gold yellow, white lacquered wood

Revêtement pieds + plateau: mélaminé chêne antique / Façades Ubi: laqué bordeaux, brouillard, tourterelle, titane, vert nature, jaune or, blanc

Beinverkleidung + Tischplatte: Melamin Eiche antik / Türen Ubi: lackiert Bordeaux, Nebelgrau, Taubengrau, Naturgrün, Goldgelb, Weiß

Bekleding poten + blad: verouderd eiken melamine / Deuren Ubi: gelakt bordeaux, mistkleur, duifgrijs, titanium, natuurgroen, goudgeel, wit

Revestimiento patas + sobre: melamina roble vintage / Puertas Ubi: lacado burdeos, niebla, gris ceniciento, titanio, verde naturaleza, amarillo gold, blanco



take off evolution **country** + flipper

Rivestimento gambe: melaminico rovere antico /
 Piano: melaminico bianco / Mobile con ante scorrevoli:
 melaminico bianco / Flipper: melaminico bianco

Beinverkleidung: Melamin Eiche antik / Tischplatte: Melamin Weiß / Sideboard mit Schiebetüren: Melamin Weiß / Flipper: Melamin Weiß

Leg coating: decapé oak melamine wood / Top: white melamine wood / Cabinets with sliding doors: white melamine wood / Flipper: white melamine wood

Bekleding poten: verouderd eiken melamine / Blad: wit melamine / Meubel met schuifdeuren: wit melamine / Flipper: wit melamine

Revêtement pieds: mélaminé chêne antique / Plateau: mélaminé blanc / Meuble avec portes coulissantes: mélaminé blanc / Flipper: mélaminé blanc

Revestimiento patas: melamina roble vintage / Sobre: melamina blanco / Mueble con puertas correderas: melamina blanco / Flipper: melamina blanco



Compositions elements & dimensions

50/51 52/53



180 x 100 H.73 cm 70¾" x 39¼" H.28¾"

Scrivania con passacavi verticale in tessuto

Desk with Vertical fabric cable tray - Bureau avec Câblage vertical en tissu - Schreibtische mit Senkrechter Kabelführung aus Stoff - Bureau met Verticale stoffen kabelgoot - Escritorio con Pasacables vertical en tejido

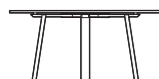

Ø160 H.73 cm Ø63" H.28¾"

Tavolo riunione rotondo

Round meeting table - Table ronde de réunion - Runder Konferenztisch - Ronde vergadertafel - Mesa redonda de reunión

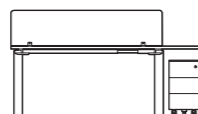

200 x 164 H.73/110 cm 78¾" x 64½" H.28¾"/43¼"

Composizione Bench

Bench composition - Poste de travail - Bench-Arbeitsplatz - Samenstelling bench - Composición bench



80/100/120 x 25 H.3 cm 31½"/39¼"/47¼" x 9¾" H.1"

Mensole a parete

Wall shelf - Étagères murales - Konsole für Wandmontage - Plank wandmontage - Estante fijación mural

54/55 56



402,4 x 46 H.79,8 cm 158½" x 18" H.31½"

Armadio mod. ABA

ABA Cabinet - Armoire ABA - Schränke ABA - Kasten ABA - Armario ABA

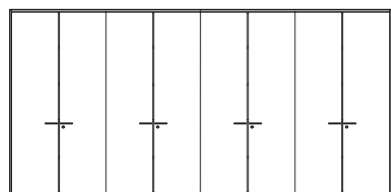

402,4 x 46 H.195 cm 158½" x 18" H.76¾"

Armadio mod. ABA

ABA Cabinet - Armoire ABA - Schränke ABA - Kasten ABA - Armario ABA

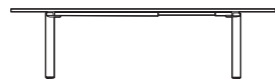

280 x 124 H.73 cm 110¼" x 48¾" H.28¾"

Tavolo riunione rettangolare

Rectangular meeting table - Table rectangulaire de réunion - Rechteckiger Konferenztisch - Rechthoekige vergadertafel - Mesa rectangular de reunión

58/59 60/61



136 x 124 H.73 cm 53½" x 48¾" H.28¾"

Tavolo riunione mod. FARM

FARM Meeting table - Table de reunion FARM - Konferenztisch FARM - Vergadertafel FARM - Mesa de reunión FARM



Ø140 H.73 cm Ø55" H.28¾"

Tavolo riunione rotondo mod. FARM

FARM Round meeting table - Table ronde de reunion FARM - Runder Konferenztisch FARM - Ronde vergadertafel FARM - Mesa redonda de reunión FARM



482 x 40 H.184 cm 189¾" x 15¾" H.72½"

Contentitori mod. UBI EVO

UBI EVO Containers - Cubes UBI EVO - Container UBI EVO - Containers UBI EVO - Contenedores UBI EVO

62/63

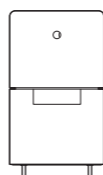

100 x 34 H.180 cm 39¼" x 13¼" H.70¾"

Mod. FLIPPER a parete

Flipper with wall fixing - Flipper avec fixation murale - Wand Flipper - Flipper voor wandmontage - Flipper a pared



120 x 40 H.72 cm 47¼" x 15¾" H.28¾"

Mobile con ante scorrevoli

Cabinet with sliding doors - Meuble avec portes coulissantes - Sideboard mit Schiebetüren - Meubel met schuifdeuren - Mueble con puertas correderas

120 x 40 H.1,8 cm 47¼" x 15¾" H.¾"

Top mobile

Finishing top for sliding doors cabinet - Top pour meuble avec portes coulissants - Abdeckplatte für Schiebetürenschränk - Topblad voor meubel met schuifdeuren - Tapa para mueble puertas correderas

For a more complete view of the collection, see the price list
Für eine vollständigere Ansicht der Sammlung finden Sie in der Preisliste
Para una visión más completa de la colección, consulte la lista de precios

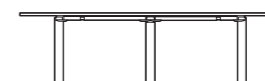

276 x 124/164 H.73 cm 108¾" x 48¾"/64½" H.28¾"

Tavolo riunione mod. FARM

FARM Meeting table - Table de reunion FARM - Konferenztisch FARM - Vergadertafel FARM - Mesa de reunión FARM



68/136 x 36 H.44 cm 26¾"/53½" x 14" H.17¼"

Panchetta

Bench - Tabouret - Sitzbank - Krukje - Banqueta

66 x 34 H.3 cm 26" x 13¼" H.1"

Cuscini imbottiti

Cushion - Coussin - Sitzpolster - Kussen - Cojin

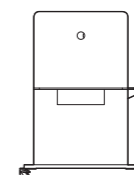

120 x 40 H.180 cm 47¼" x 15¾" H.70¾"

Mod. FLIPPER su ruote

Flipper on castors - Flipper sur roulettes - Flipper auf Rollen - Flipper op wielen - Flipper sobre ruedas

48 x 28 H.1,8 cm 18¾" x 11" H.¾"

Mensola Flipper

Flipper shelf - Étagère pour Flipper - Konsole für Flipper - Plank voor Flipper - Estante para Flipper



220 x 124 H.72 cm 86¾" x 48¾" H.28¾"

Tavolo riunione sagomato

Shaped meeting table - Table elliptique de réunion - Geformter Konferenztisch - Gevormde vergadertafel - Mesa con forma de reunión

take off
evolution

technical

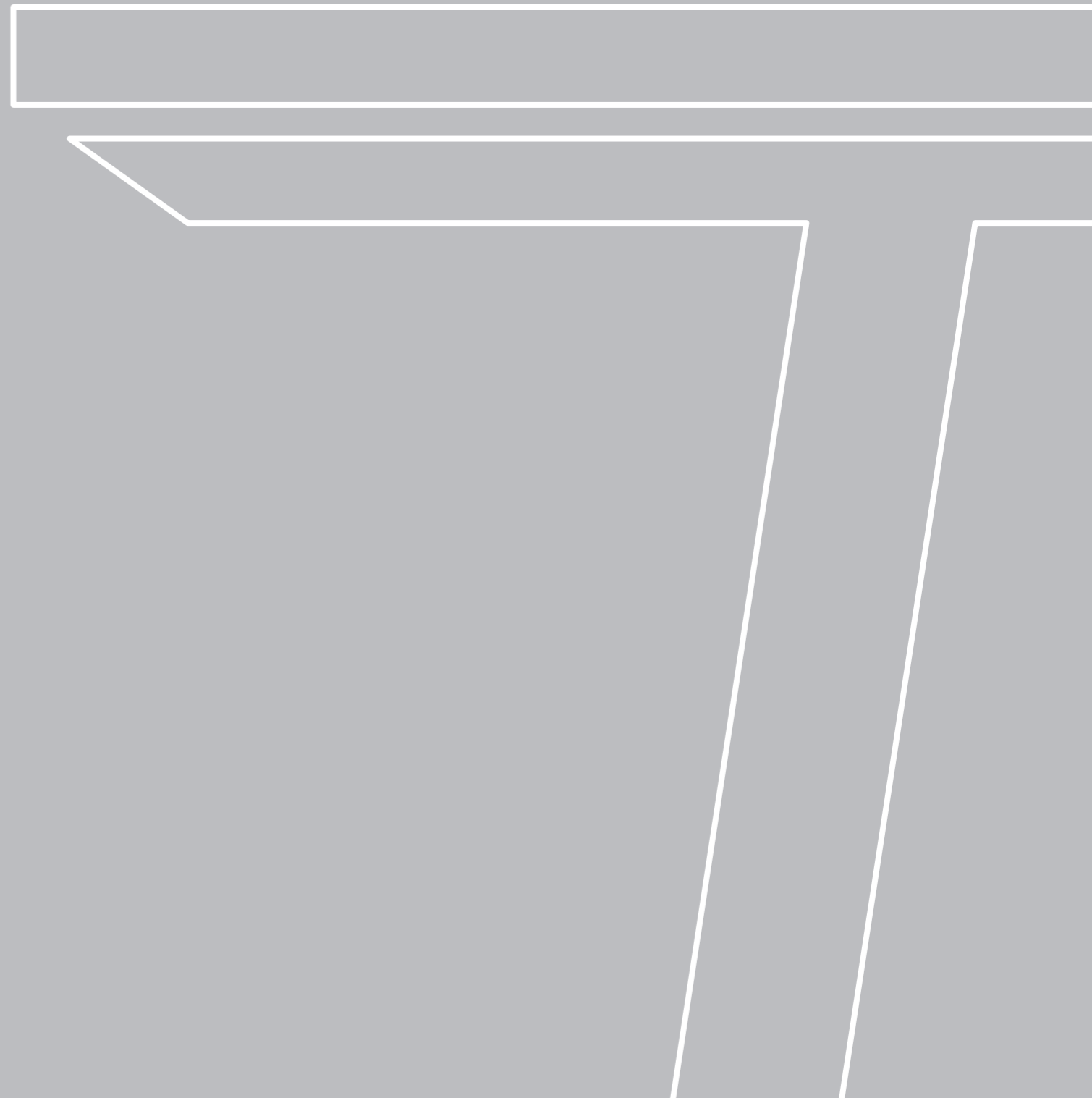

Tipologie schermi - Types of panels - Types d'écrans - Sichtschutz-Typen - Schermtypen - Tipos de pantallas

Per una più completa visione della collezione, consultare il listino
Pour un meilleur aperçu de la collection, veuillez consulter la liste des prix
Om de volledige collectie te raadplegen, zie de lijst

To view the collection in more detail, Please refer to our price list
Eine komplette Ansicht der Kollektion finden Sie in der Preisliste
Para ver más detalladamente la colección, consultar la tarifa

Schermi divisori - Screens dividers - Écrans de séparation frontale - Sichtschutzpaneele - Schermverdeling - Pantalla separadora



Schermo divisorio vetro sp 8 mm / 0¼"
Glass screen
8 mm / 0¼" thick
Écran de séparation frontale verre ép. 8 mm / 0¼"
Sichtschutzpaneel Glas Stärke 8 mm / 0¼"
Glazen schermverdeling dikte 8 mm / 0¼"
Pantalla separadora de cristal esp. 8 mm / 0¼"

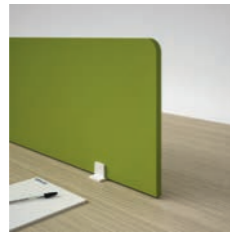

Schermo divisorio laccato sp 18 mm / 0¾"
Lacquered screen
18 mm / 0¾" thick
Écran de séparation frontale laqué ép. 18 mm / 0¾"
Sichtschutzpaneel lackiert Stärke 18 mm / 0¾"
Gelakte schermverdeling dikte 18 mm / 0¾"
Pantalla separadora lacada esp. 18 mm / 0¾"



Schermo divisorio melaminico sp 18 mm / 0¾"
Melamine screen
18 mm / 0¾" thick
Écran de séparation frontale mélaminé ép. 18 mm / 0¾"
Sichtschutzpaneel Melamin Stärke 18 mm / 0¾"
Schermverdeling in melamine dikte 18 mm / 0¾"
Pantalla separadora melamina esp. 18 mm / 0¾"



Schermo divisorio in tessuto sp 18 mm / 0¾" con profilo
Fabric screen 18 mm / 0¾" thick with profile
Écran de séparation frontale en tissu ép. 18 mm / 0¾" avec profil
Sichtschutzpaneel aus Stoff Stärke 18 mm / 0¾" mit Profil
Stoffen schermverdeling dikte 18 mm / 0¾" met profiel
Pantalla separadora de tejido esp. 18 mm / 0¾" con perfil



Schermo divisorio in tessuto fonoassorbente sp 42 mm / 1¾" con profilo
Sound-absorbing fabric screen 42 mm / 1¾" thick with profile
Écran de séparation frontale en tissu insonorisant ép. 42 mm / 1¾" avec profil
Sichtschutzpaneel aus schallschluckendem Stoff Stärke 42 mm / 1¾" mit Profil
Schermverdeling in geluiddempende stof dikte 42 mm / 1¾" met profiel
Pantalla separadora de tejido fonoabsorbente esp. 42 mm / 1¾" con perfil

Schermi divisori laterali - Side screens dividers - Écrans de séparation latérale - Seitliche Sichtschutzpaneele - Schermverdeling zijkant - Pantalla separadora lateral



Schermo divisorio laterale laccato sp 18 mm / 0¾"
Lacquered side screen
18 mm / 0¾" thick
Écran de séparation latérale laqué ép. 18 mm / 0¾"
Seitliches Sichtschutzpaneel lackiert Stärke 18 mm / 0¾"
Gelakte schermverdeling zijkant dikte 18 mm / 0¾"
Pantalla separadora lateral lacada esp. 18 mm / 0¾"



Schermo ripizionabile in tessuto fonoassorbente sp 42 mm / 1¾"
Fabric side screen
42 mm / 1¾" thick
Écran de séparation latérale en tissu ép. 42 mm / 1¾"
Seitliches Sichtschutzpaneel aus schallschluckendem Stoff Tiefe 42 mm / 1¾"
Stoffen schermverdeling zijkant dikte 42 mm / 1¾"
Pantalla separadora lateral de tejido esp. 42 mm / 1¾"

Schermi frontali - Front screens - Écrans frontal - Frontaler Sichtschutz - Scherm voorkant - Pantalla frontal



Schermo frontale melaminico sp. 18 mm / 0¾"
Front melamine wood screen
18 mm / 0¾" thick
Écran frontal mélaminé ép. 18 mm / 0¾"
Frontaler Sichtschutz Melamin Stärke 18 mm / 0¾"
Scherm voorkant melamine dikte 18 mm / 0¾"
Pantalla frontal melamina esp. 18 mm / 0¾"



Schermo frontale tessuto sp. 18 mm / 0¾"
Front fabric screen
18 mm / 0¾" thick
Écran frontal en tissu ép. 18 mm / 0¾"
Frontaler Sichtschutz aus Stoff Stärke 18 mm / 0¾"
Scherm voorkant in stof dikte 18 mm / 0¾"
Pantalla frontal de tejido esp. 18 mm / 0¾"



Schermo frontale alto melaminico sp. 18 mm, 0¾"
Front high melamine wood screen
18 mm / 0¾" thick
Écran frontal haut mélaminé ép. 18 mm / 0¾"
Frontaler Hoher Sichtschutz Melamin Stärke 18 mm / 0¾"
Hoog scherm voorkant melamine dikte 18 mm / 0¾"
Pantalla frontal alta melamina esp. 18 mm / 0¾"

Possibili posizioni degli schermi sui piani - Possible screen positions on the tops - Positions possibles des écrans sur les plateaux - Mögliche Aufstellungen der Sichtschutzpaneele auf den Tischplatten - Mogelijke posities van de schermen op de bladen - Posibles posiciones de las pantallas en los sobres

Per una più completa visione della collezione, consultare il listino
Pour un meilleur aperçu de la collection, veuillez consulter la liste des prix
Om de volledige collectie te raadplegen, zie de lijst

To view the collection in more detail, Please refer to our price list
Eine komplette Ansicht der Kollektion finden Sie in der Preisliste
Para ver más detalladamente la colección, consultar la tarifa

Piano da 4 postazioni - Desk top 4 positions - Bureau 4 positions - Platte für 4 Arbeitsplätze - Bureau top 4 posities - Escritorio 4 posiciones



Piano da 2 postazioni - Desk top 2 positions - Bureau 2 positions - Platte für 2 Arbeitsplätze - Bureau top 2 posities - Escritorio 2 posiciones



Piano da 1 postazione - Desk top 1 position - Bureau 1 position - Platte für 1 Arbeitsplatz - Bureau top 1 posities - Escritorio 1 posición



Piano da 1 postazione - Desk top 1 position - Bureau 1 position - Platte für 1 Arbeitsplatz - Bureau top 1 posities - Escritorio 1 posición



Sistemi per il passaggio cavi e per l'elettificazione dei piani - Cable holding and top electrification systems - Systèmes passe-câbles et pour l'électrification des plateaux - Systeme für Kabeldurchlass und Elektrifizierung der Tischplatten - Kabeldoorvoersystemen en bekabelingssystemen van de bladen - Sistemas para el paso de los cables y para la electrificación de los sobres



salita cavi tramite vertebra
vertebra cable holder / vertèbre montée de câbles / Kabelaufgang durch Spirale / omhoogwerking kabels via geleider / ascenso de los cables mediante vértebra

uscita cavi sul piano tramite top access
cable duct tray with top access / sortie des câbles sur le dessus au travers un top access / Kabeldurchführung auf der Tischplatte durch Top Access / kabeluitgang op het blad via toegang / salida de los cables en el sobre mediante top access

l'ampio alloggiamento nel cestello sottopiano permette di mantenere ordinati e facilmente ispezionabili tutti i cavi e le connessioni

the wide under-top tray houses all the cables and connections, allowing you to inspect them at any time / le large logement dans le bac sous le plateau permet de maintenir rangé et facile d'accès tous les câbles et connexions / Der geräumige Platz des Unterbaukorbes ermöglicht Ordnung und Inspezierbarkeit aller Kabel und Anschlüsse / dankzij de ruime kabelhouder onder het blad kunnen alle kabels en verbindingen ordelijk bewaard worden en kunnen ze eenvoudig gecontroleerd worden / el amplio alojamiento de la cesta presente bajo el sobre permite mantener en orden todos los cables y las conexiones facilitando su inspección

salita cavi attraverso la gamba centrale: pannello riposizionabile per una facile ispezionabilità dell'alloggiamento e foro passacavi
cable holder in the central leg: easily detachable panel to inspect the cable holder hole and housing / montée des câbles à travers le pied central: panneau repositionnable pour faciliter l'inspection du logement et passe-câbles / Kabelaufgang durch das zentrale Bein mit einer abnehmbaren Blende zwecks einfacher Inspektion, und Kabeldurchlass / omhoogwerking kabels via de centrale poot: herpositioneerbaar paneel voor een eenvoudige inspectie van de houder en de kabeldoorvoeropening / ascenso de los cables a través de la pata central: panel desplazable para facilitar la inspección del alojamiento y orificio pasacables

Per una più completa visione della collezione, consultare il listino
Pour un meilleur aperçu de la collection, veuillez consulter la liste des prix
Om de volledige collectie te raadplegen, zie de lijst

To view the collection in more detail, Please refer to our price list
Eine komplette Ansicht der Kollektion finden Sie in der Preisliste
Para ver más detalladamente la colección, consultar la tarifa

uscita cavi sul piano tramite top access
cable duct tray with top access / sortie des câbles sur le dessus au travers un top access / Kabeldurchführung auf der Tischplatte durch Top Access / kabeluitgang op het blad via toegang / salida de los cables en el sobre mediante top access

alloggiamento in filo metallico sottopiano per la raccolta dei cavi
metal wire mesh cable housing underneath the top / logement en fil métallique au-dessous de la partie supérieure pour la collecte des câbles / Unterbau-Gitterbehälter zur Unterbringung der Kabel / houder in metaaldraad onder het blad om de kabels op te vangen / alojamiento de metálico bajo el sobre para recoger los cables



ampia vaschetta in filo metallico per la raccolta dei cavi ed una loro facile ispezionabilità
large wire mesh cable tray, which allows you to inspect them at any time / grand bac en fils métalliques pour la collecte des câbles et pour faciliter leur inspection / Geräumiger Unterbau-Gitterbehälter zur Unterbringung der Kabel und einfachen Inspektion / ruim bakje in metaaldraad om de kabels op te vangen en moeiteloos te kunnen inspecteren / amplia bandeja metálica para recoger los cables facilitando su inspección

salita cavi tramite vertebra
vertebra cable holder / colonne montée des câbles / Kabelaufgang durch Spirale / omhoogwerking kabels via geleider / ascenso de los cables mediante vértebra

uscita cavi sul piano tramite top access
cable duct tray with top access / sortie des câbles sur le plateau au travers un top access / Kabeldurchführung auf der Tischplatte durch Top Access / kabeluitgang op het blad via toegang / salida de los cables en el sobre mediante top access

la salita cavi può avvenire tramite un apposito passaggio sul lato della piantana, oppure direttamente all'interno della stessa
cables can be conveyed through a special housing on the side of the table base or directly within it / la montée des câbles peut avoir lieu à travers un passage spécial sur le côté du pied, ou directement à sa base / Der Kabelaufgang erfolgt durch die entsprechende Bohrung seitlich der Mittelsäule oder wahlweise direkt in Inneren der Säule / de kabels kunnen omhoog gewerkt worden via een speciale opening aan de kant van de staande lamp, of rechtstreeks erin / los cables pueden subir a través de un orificio a un lado de la columna de apoyo o directamente por el interior de la misma



Flipper, struttura e sistema di elettrificazione - Flipper, structure and electrification system - Flipper, structure et système d'électrification - Flipper, Struktur und Elektrifizierungssystem - Flipper, structuur en bekabelingssysteem - Flipper, estructura y sistema de electrificación

i cavi elettrici e i dati entrano dal basso o da appositi passaggi laterali e sono resi disponibili in diverse posizioni per alimentare il TV sul pannello frontale, oppure un tablet sulla mensola dedicata o ancora una web cam collocabile sulla parte superiore

electric and data cable enter from the bottom or through special side holes, and are available in different position to supply the TV on the front panel, or a tablet on the special shelf, or a webcam which can be connected on the rear section / les câbles électriques et de données entrent par le bas ou par des passages latéraux spéciaux et ils sont mis à disposition dans des positions différentes pour alimenter le téléviseur sur le panneau avant, ou une tablette sur la console dédiée ou même une webcam pouvant être placée sur la partie supérieure / Elektrische Kabel oder Datenleitungen kommen von unten oder durch seitliche Öffnungen und sind in mehreren Positionen verfügbar zur Versorgung eines Fernsehers auf der Frontblende, eines Tablets auf der entsprechenden Konsole oder einer Webcam, die auf der oberen Seite positioniert werden kann / de voedings- en gegevenskabels komen van onderen naar binnen of door speciaal hiervoor bestemde openingen aan de zijkant en worden beschikbaar gemaakt in verschillende posities om de televisie op het voorpaneel te voeden, of een tablet op de hiervoor bestemde plank of een webcam die op het bovengedeelte geplaatst kan worden / los cables eléctricos y de datos entran por abajo o por unos orificios laterales y resultan disponibles en distintas posiciones para alimentar la TV en el panel frontal, una tableta en el estante correspondiente o una cámara web colocada en la parte superior

il pannello svolge anche la funzione di lavagna scrivibile

the panel is also a blackboard / le panneau sert également de tableau blanc / Die Blende hat auch die Funktion einer beschriftbaren Tafel / het paneel doet ook dienst als beschrijfbaar bord / el panel desempeña también la función de pizarra escribible

i pannelli sono facilmente riposizionabili per un agevole posizionamento, controllo o manutenzione dei cavi all'interno

all panels can be easily detach to place, check or service the cables inside / les panneaux peuvent être facilement repositionnés pour faciliter le positionnement, le contrôle ou l'entretien des câbles à l'intérieur / Die Blenden sind mühelos abnehmbar für eine einfache Inspektion und wartung der Kabel im Innenraum / de panelen kunnen gemakkelijk geherponeerd worden voor een gemakkelijke plaatsing, controle of onderhoud van de interne kabels / los paneles pueden desplazarse cómodamente para facilitar la colocación, el control o el mantenimiento de los cables presentes en el interior

ruote di ampie dimensioni per una agevole traslazione, dotate di blocco

wide wheels with locking brake / grandes roues pour un déplacement aisé, équipées de frein / große Laurollen für eine einfache Bewegung, ausgestattet mit Arretierung / grote wielen voor een vlotte verplaatsing, met blokkering / ruedas de amplias dimensiones para facilitar el desplazamiento, dotadas de bloqueo

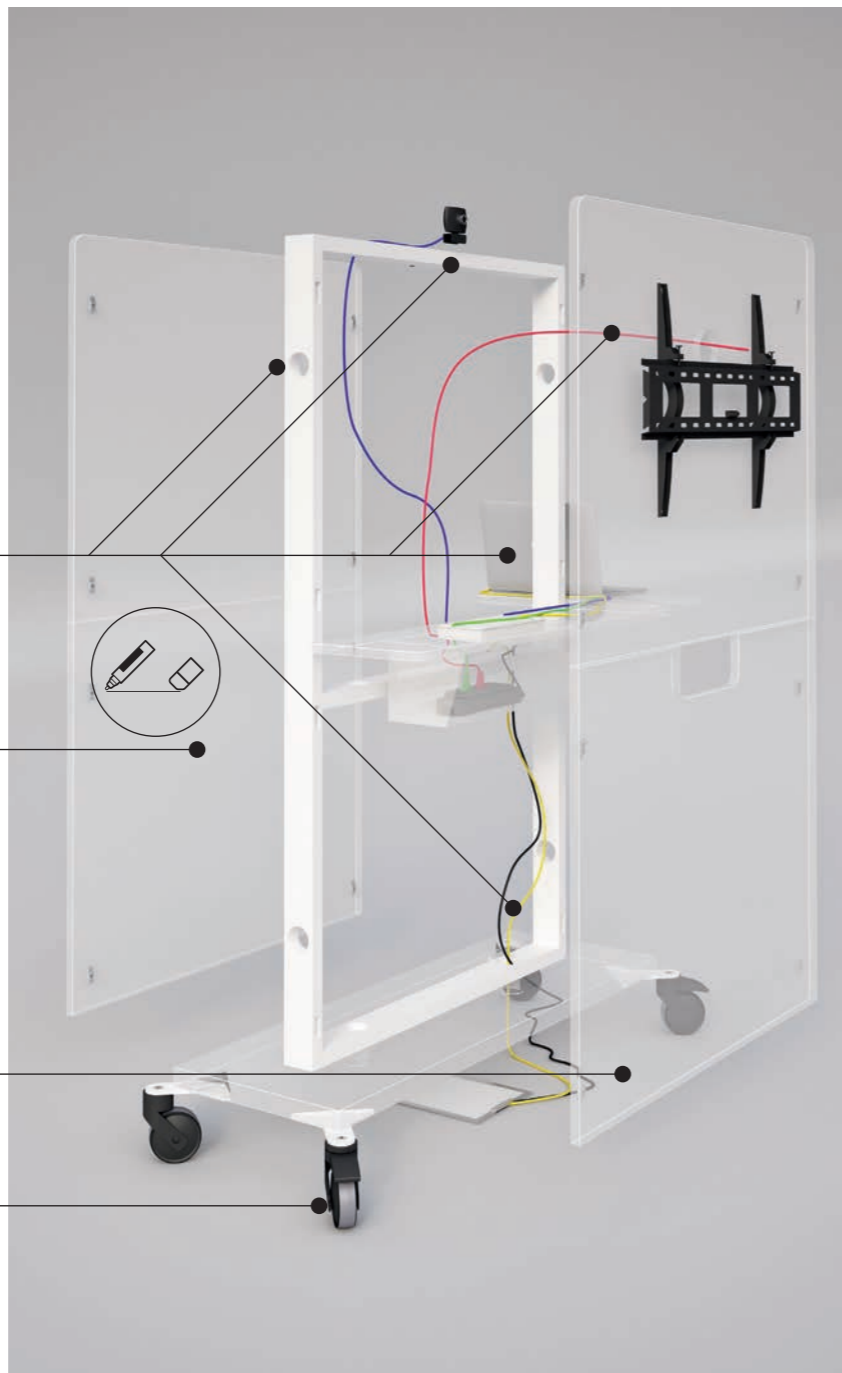

Per una più completa visione della collezione, consultare il listino
Pour un meilleur aperçu de la collection, veuillez consulter la liste des prix
Om de volledige collectie te raadplegen, zie de lijst

To view the collection in more detail, Please refer to our price list
Eine komplette Ansicht der Kollektion finden Sie in der Preisliste
Para ver más detalladamente la colección, consultar la tarifa

i cavi di alimentazione e dati possono entrare dagli appositi passaggi Flipper, alimentare i vari devices presenti ed essere resi disponibili anche per il piano meeting

electric and data cable enter from the special holes on Flipper holes, to supply the different devices, and can be extended also to the meeting table / les câbles d'alimentation et de données peuvent entrer par des passages spéciaux du Flipper, alimenter les divers appareils électriques présents et être mis à disposition également pour le dessus de la table de réunion / elektrische Kabel und Datenleitungen für Geräte können durch vorgesehene Öffnungen von Flipper eingeführt werden, und auch auf der Tischplatte verfügbar sein / de voedings- en gegevenskabels kunnen door de speciaal hiervoor bedoelde geleidingen van Flipper gestoken worden, de verschillende aanwezige toestellen voeden en ook beschikbaar zijn op het vergaderblad / los cables de alimentación y de datos pueden entrar por los orificios correspondientes de Flipper, alimentar los distintos dispositivos y resultar también disponibles para el sobre de la mesa de reuniones

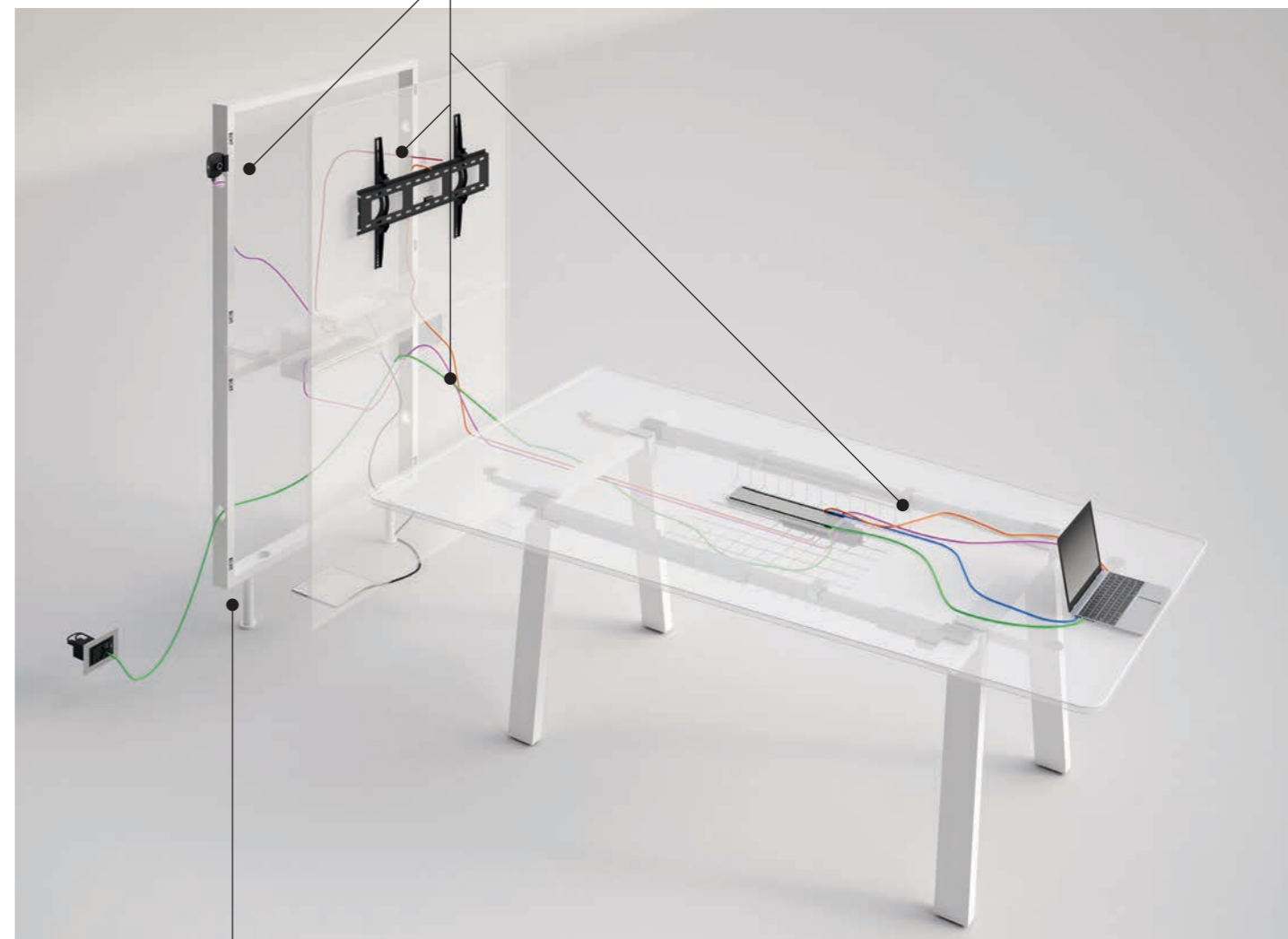

Flipper, nella versione a muro, è dotato di piedini di sostegno e regolazione

the wall version of Flipper is equipped with support and adjustment feet / Flipper, dans sa version murale, est équipé de pieds de support réglables / Flipper in der Wandausführung ist mit Stütz- und Justierfüßchen ausgestattet / de muurversie van Flipper beschikt over ondersteunende en afstelbare poten / en la versión de pared, Flipper está dotado de patas de soporte y regulación

Sistema Ubi - Ubi system - Système Ubi - Ubi System - System Ubi - Sistema Ubi

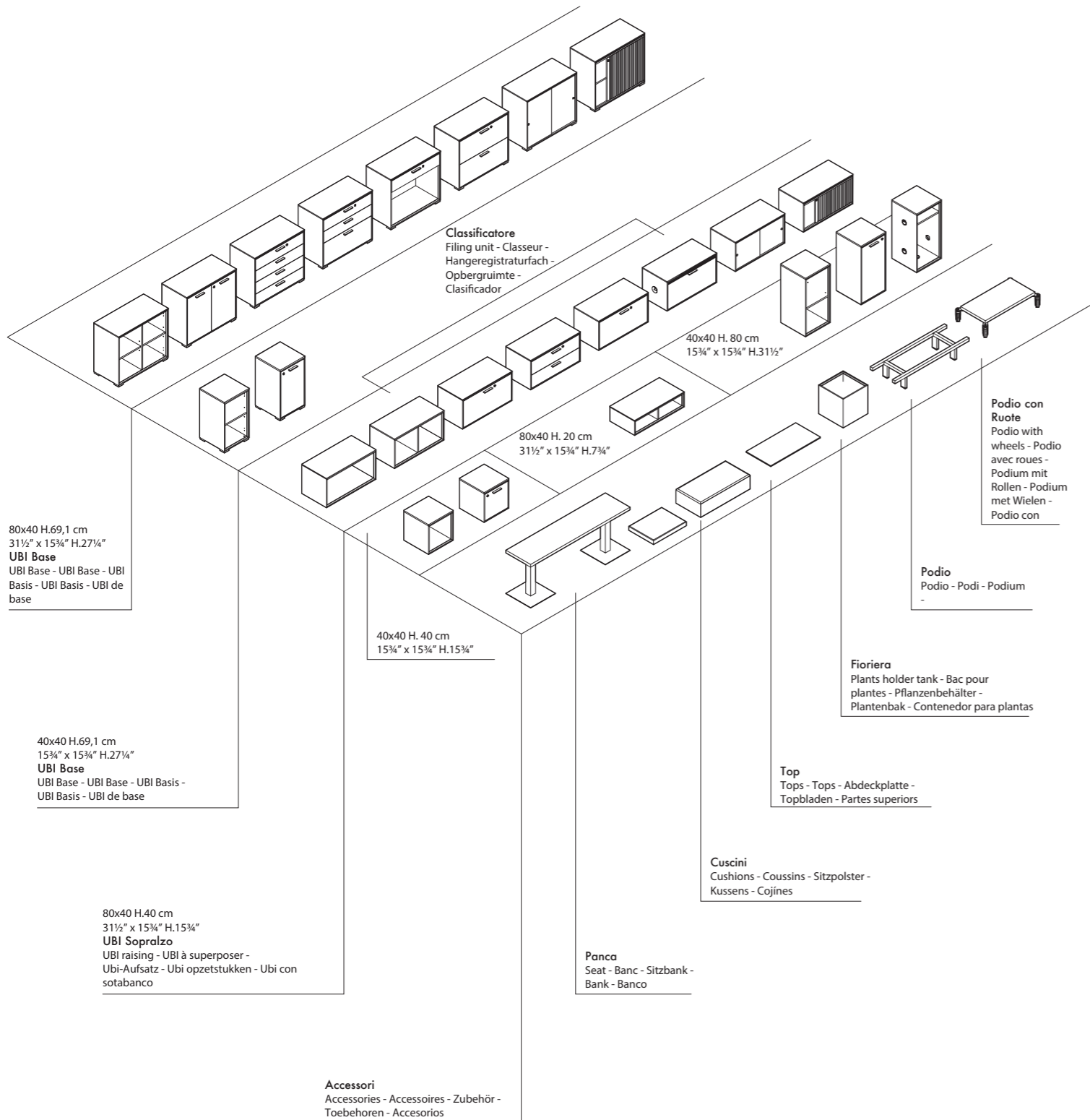

Cassettiere e mobili di servizio - Drawers and service cabinets - Caissons et meubles de service -
Container und Sideboards - Ladekasten en meubels - Cajoneras y muebles de servicio

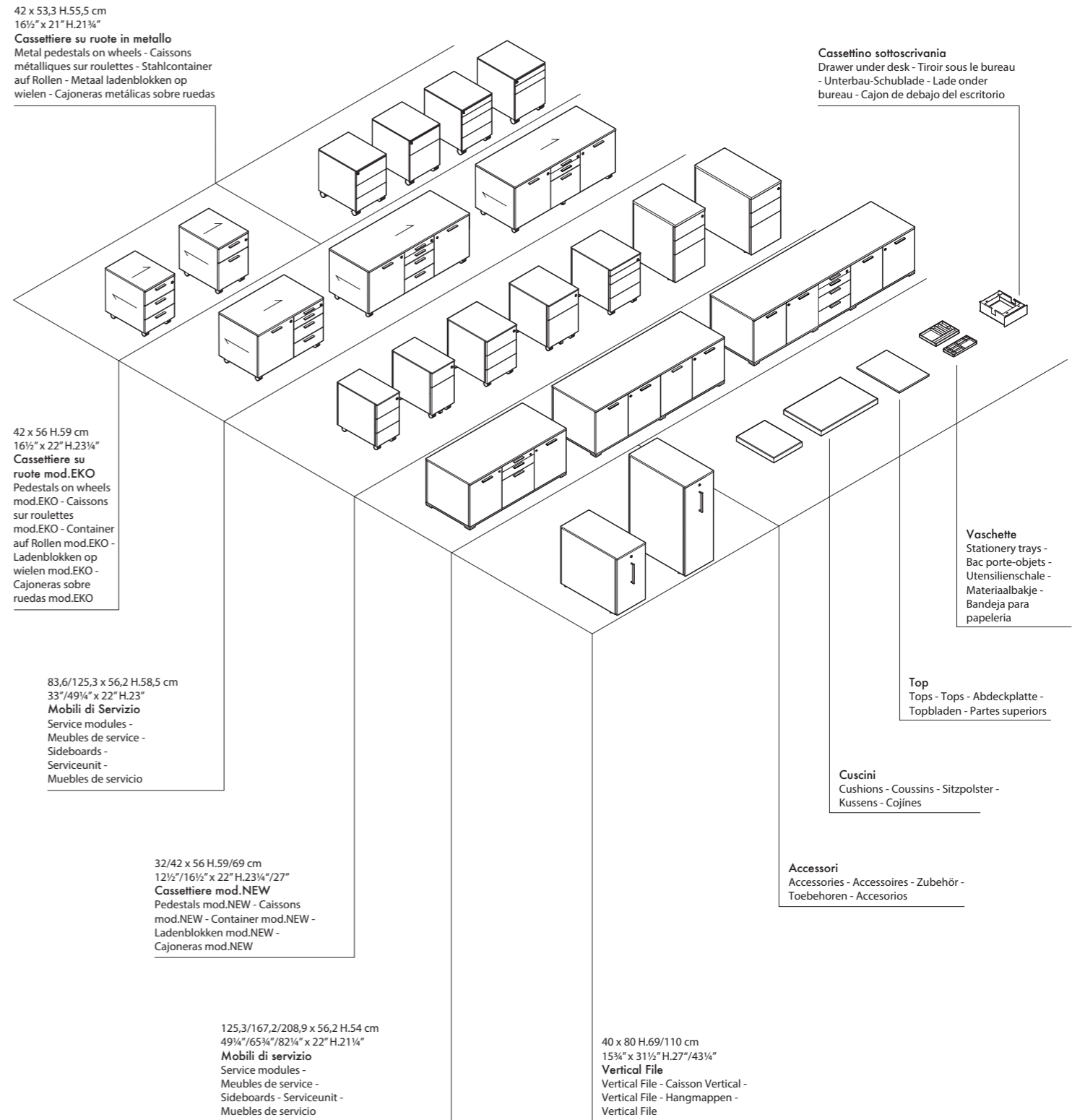

Armadi ABA p.36 cm / 14" - ABA closet system - d. 36 / 14" - Système de placards ABA - p. 36/14" - Schranksystem ABA - Tiefe 36/14" - Systeem Kasten ABA - d. 36/14" - Sistema Armarios ABA - p. 36/14"

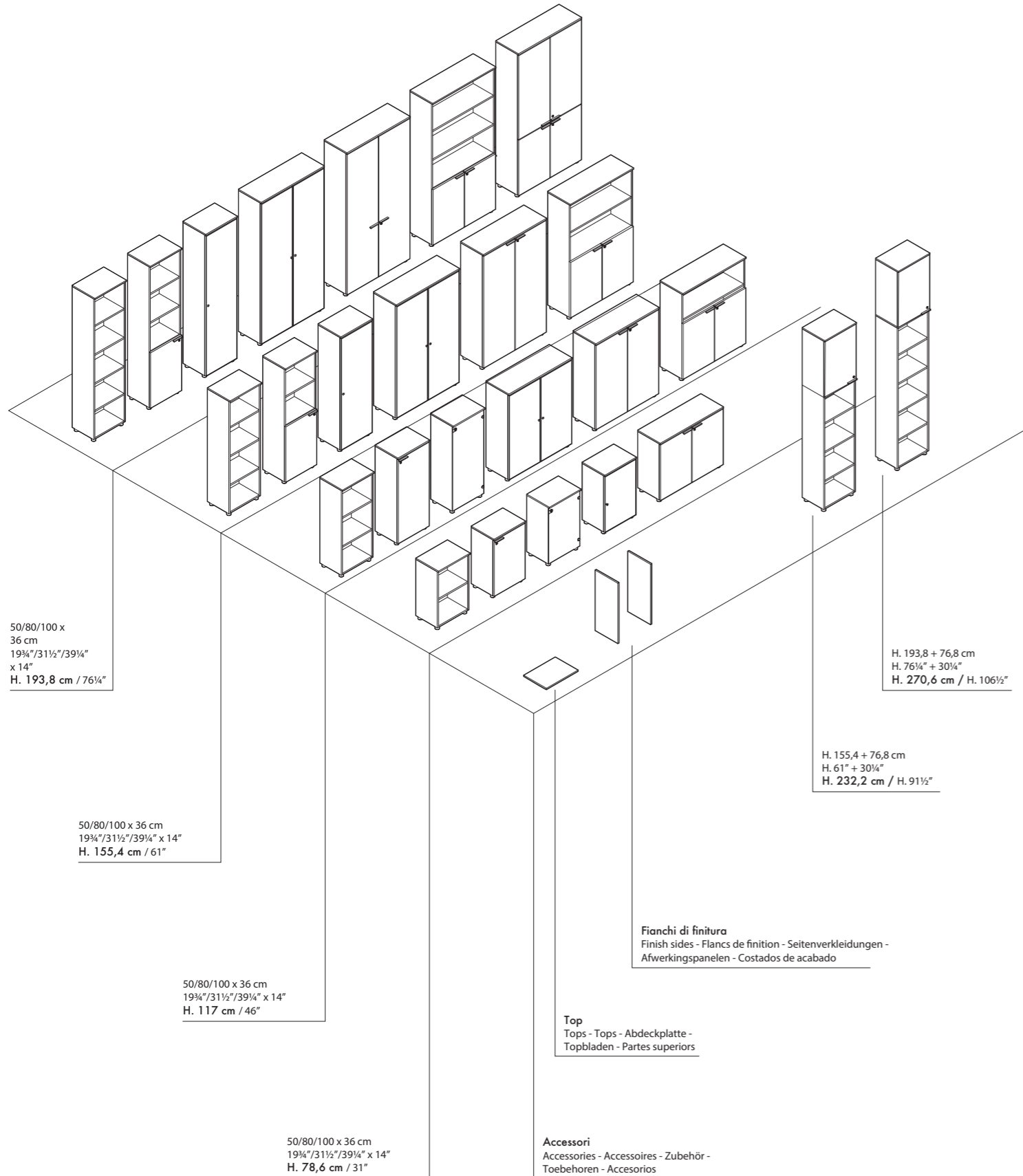

Armadi ABA p.46 cm / 18" - ABA closet system - d. 46 / 18" - Système de placards ABA - p. 46/18" - Schranksystem ABA - Tiefe 46/18" - Systeem Kasten ABA - d. 46/18" - Sistema Armarios ABA - p. 46/18"

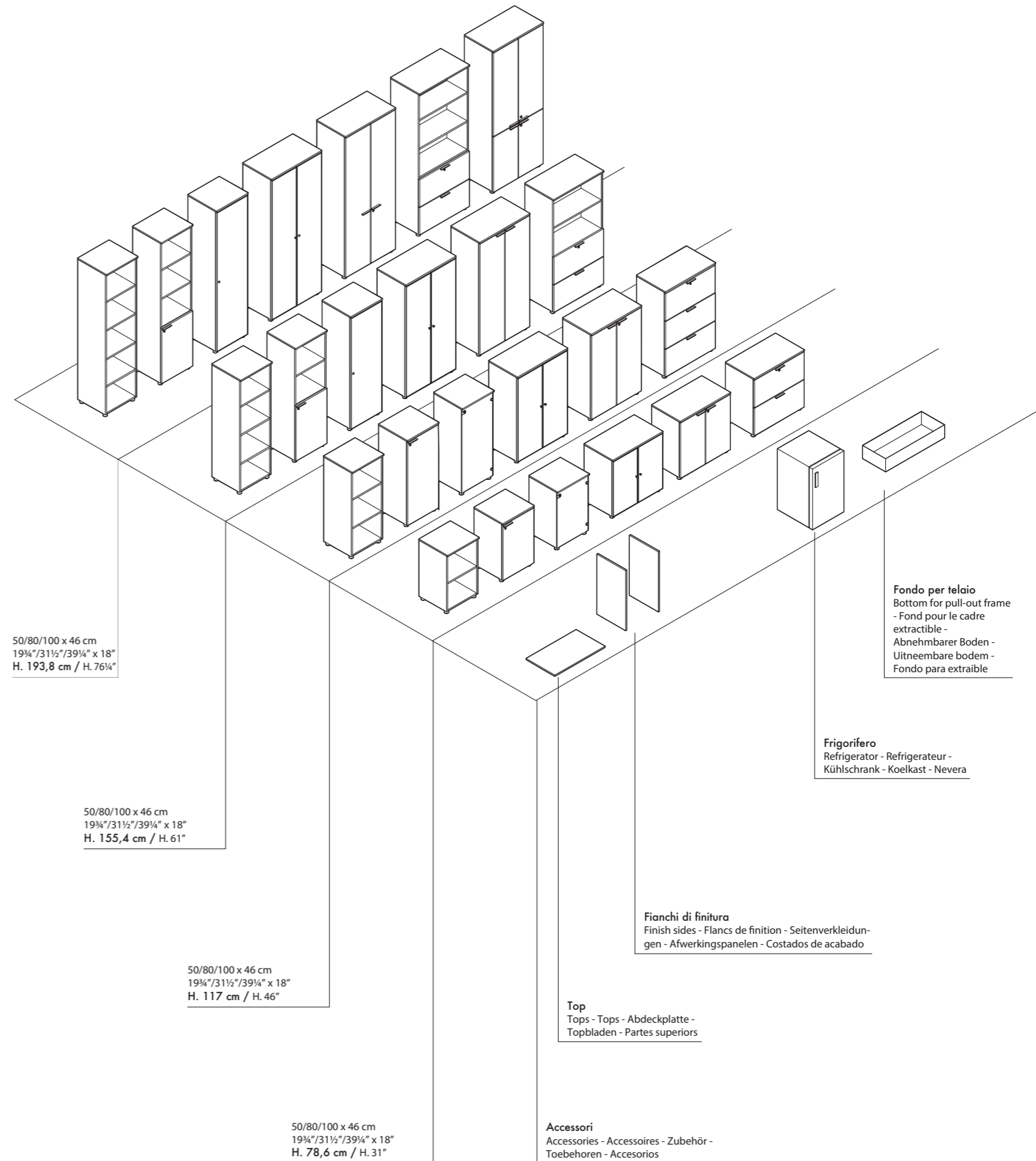

Accessori - Accessories - Accessoires - Zubehör - Accessoires - Accesorios

Tappo passacavi - Cable access port - Passe-câbles - Kabeldurchlass - Kabeldoorgang - Tapon pasacables



GZ.0008.B0
Tappo passacavi quadrato
Square cable access port
Passe-câbles carré
Quadratischer Kabeldurchlass
Vierkante kabeldoorgang
Tapon pasacables cuadrado



GZ.0008.A0
Tappo passacavi rotondo
Round cable access port
Passe-câbles rond
Runder Kabeldurchlass
Ronde kabeldoorvoer
Tapon pasacables redondo

Top access - Top access - Top access - Top-Access - Top toegang - Acceso superior



GZ.0058.A2
Top access per piano scrivania
Top access
Top access
Top-Access
Top toegang
Acceso superior



GZ.0024.A1/A3 + GZ.0012.EU/FR/UK
Top access + Kit blocco portaprese
Top access + Kit foldway socket halde
Top access + Kit bloc porte-prises
Top-Access+ Elektro-Dosenblock
Top toegang + Kit power unit
Acceso superior + Kit de bloque portaenchufe



GZ.0062.A3
Top access
Top access
Top access
Top-Access
Top toegang
Acceso superior

Per una più completa visione della collezione, consultare il listino
Pour un meilleur aperçu de la collection, veuillez consulter la liste des prix
Om de volledige collectie te raadplegen, zie de lijst

To view the collection in more detail, Please refer to our price list
Eine komplette Ansicht der Kollektion finden Sie in der Preisliste
Para ver más detalladamente la colección, consultar la tarifa

Cestelli portacavi - Cables holder baskets - Bac porte-cables - Kabel-hartekorb - Korfjes voor elektrische bedrading - Cestos portaenchufes



GZ.0018.00 GZ.0048.01
Cestelli portacavi ruotabile ed ispezionabile
Cables holder baskets rolling and inspectionable
Bac porte-cables basculant
Kabel halterkorb, schwenk-und einsehbar
Draaibare en controleerbare korfjes voor elektrische bedrading
Cestos portaenchufes que se vuelva e inspeccionar

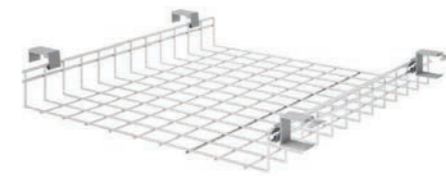

GZ.0063.01 GZ.0064.01



GZ.0040.01 GZ.0026.01

Portaprese - Socket-holder - Porte-prises - Elektro-Dosenblock - Stekker - Conector



GZ.0057.AE/AF/AU
Blocco portaprese Versapad
Foldway socket holder Versapad
Boîtier de prises Versapad
Elektro-Dosenblock
Ingewerkte contactdoos Versapad
Base de conexiones Versapad



GZ.0066.A1
Caricabatterie Wireless
Wireless charger
Chargeur sans fil
Wireless-Ladegerät
Draadloze oplader
Cargador inalámbrico



GZ.0019.A0/AF
Blocco portaprese a scomparsa
Foldway cable management module
Bloc porte-prises
Versenkbarer Dosenblock
Power unit voor aansluitingen
Bloque porta enchufe de corriente oculto

Accessori - Accessories - Accessoires - Zubehör - Accessoires - Accesorios

Per una più completa visione della collezione, consultare il listino
Pour un meilleur aperçu de la collection, veuillez consulter la liste des prix
Om de volledige collectie te raadplegen, zie de lijst

To view the collection in more detail, Please refer to our price list
Eine komplette Ansicht der Kollektion finden Sie in der Preisliste
Para ver más detalladamente la colección, consultar la tarifa

Passacavi - Cables-carrier - Passage de câbles - Kabeldurchlass - Kabeldoorvoer - Pasacables



BZ.0072.00
Passacavi
Cables-carrier
Montée de câbles
Kabeldurchlass
Kabeldoorvoer
Pasacables



GZ.0070.01



GZ.0059.01
Passacavi in tessuto Puma
Vertical fabric Puma cable tray
Câblage vertical en tissu Puma
Senkrechte Kabelführung aus Stoff Puma
Verticale stoffen Puma kabelgoot
Pasacables vertical en tejido Puma

Porta cpu - Cpu holder - Porte UC - Computerträger - Cpu-houder - Porta cpu



GZ.0021.00
Porta cpu metallico (appeso alla gamba)
Cpu holder (suspended to the leg)
Porte UC en métal (suspendu à la jambe)
Computerträger mit Beinaufhängung
Metalen cpu-houder (bevestigd aan het been)
Porta cpu metálico (colgado a la pata)

Braccio portavideo - Adjustable monitor arm - Bras porte-écran - Monitor-Trägerarm - Regelbare monitorarm - Brazo-soporte para monitor



GZ.0081.M1
Braccio portavideo con morsetto
Adjustable monitor arm with clamp
Bras porte-écran avec pince
Monitor-Trägerarm mit Klemmvorrichtung
Regelbare monitorarm met klem
Brazo-soporte para monitor con brida



GZ.0060.01 GZ.0060.02
Porta monitor con morsetto (singolo-doppio)
Monitor stand with clamp (single-double)
Porte-écran avec pince (simple-double)
Monitorträger mit Klemme (Einzel-Doppel)
Monitorsteun met clips (enkele, dubbele)
Para monitor con borne (individuales, dobles)





Cassetino sottocrivania - Personal Stationery Drawer under desk - Tiroir sous le bureau - Unterbau-Schublade - Lade onder bureau - Cajón de debajo del escritorio



TZ.0304.00
Cassetino sottocrivania
Personal Stationery Drawer under desk
Tiroir sous le bureau
Unterbau-Schublade
Lade onder bureau
Cajón de debajo del escritorio

Finiture - Finishes - Finitions - Oberflächen - Afwerkingen - Acabados





Melaminico - Coated panel - Mèlamine - Melamin - Melamine - Melamina

AL  Alluminio Aluminium Aluminium Aluminium Aluminium Aluminio	AN  Acero Champagne Champagne Hard Maple Érable Champagne Champagner-Ahorn Esdoorn Champagne Arce Champán	BL  Bianco White Blanc Weiß Wit Blanco	MH  Nebbia Mist Brouillard Nebelgrau Mist Niebla	MO  Tortora Turtledove Tourterelle Turteltaube Tortelduif Tórtola	GP  Grigio Perla Pearl-Grey Gris Perle Perlgrau Parelgrijs Gris Perla
GS  Grigio Granito Granite Grey Gris Granit Granitgrau Granietgrijs Gris Granito	MK  Nero Black Noir Schwarz Zwart Negro	RN  Rovere Naturale Natural Oak Chêne Naturel Natur Eiche Eikenhout Natuur Roble Natural	NC  Noce Canaletto Canaletto Walnut Noyer Canaletto Canaletto Nussbaum Notenhout Canaletto Nagal Canaletto	WW  Wengé Scuro Dark Wengé Wengé Foncé Dunkel Wengé Donker Wengé Wengé Oscuro	RA  Rovere Anticato Traditional Oak Chêne Vieilli Eiche Antik Oud Eiken Decor Melamine Melamina Roble Antiquo



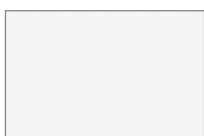







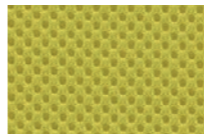
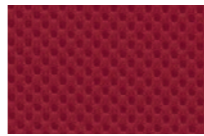
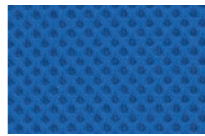

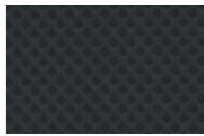
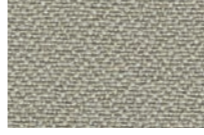

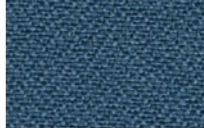

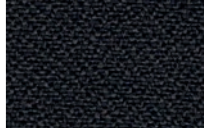
Laccato opaco - Matt lacquered - Lacqué mat - Matt lackiert - Matgelakt - Lacado mate

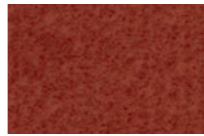
LB  Bianco White Blanc Weiß Wit Blanco	L3  Nebbia Mist Brouillard Nebelgrau Mist Niebla	L2  Tortora Turtledove Tourterelle Turteltaube Tortelduif Tórtola	L4  Titanio Titanium Titane Titan Titanium Titanio	L5  Oceano Ocean Océan Meerblau Ocean Oceano	LE  Deep Teal Deep Teal Bleu Canard Titan Titanium Titanio
LF  Verde Natura Gras Green Vert Nature Grasgrün Groene Natuur Verde Naturaleza	L6  Verde Muschio Moss Green Vert Mousse Moosgrün Mosgroen Verde Musgo	LJ  Giallo Gold Yellow Gold Jaune Or Goldgelb Geelgouden Oro Amarillo	LN  Nero Black Noir Schwarz Zwart Negro	LA  Alluminio Aluminium Aluminium Aluminium Aluminium Aluminio	LR  Bordeaux Bordeaux Bordeaux Bordeaux Bordeaux Bordeaux

Strutture metalliche - Metal structures - Structures métalliques - Metallstrukturen - Metalen structuren - Estructura metálicas

AF  Epoxy Alluminio Silver Epoxy Epoxy Aluminium Aluminium Aluminiumkleur Geepoxideerd Epoxidica De Aluminio	BW  Bianco White Blanc Weiß Wit Blanco	TF  Tortora Turtledove Tourterelle Turteltaube Tortelduif Tórtola	GF  Grigio Granito Granite Grey Gris Granit Granitgrau Granietgrijs Gris Granito	NF  Nero Black Noir Schwarz Zwart Negro	KR  Cromo Lucido Glossy Chrome Chromé Brillant Chrom Poliert Glanzend Verchroomd Cromo Pulido
--	---	--	---	---	--

Tessuto - Fabric - Tissu - Stoff - Stof - Tejido

Puma A + B  Verde Mela Apple Green Vert Pomme Apfelgrün Appelgroen Verde Manzana	P4  Bordeaux Bordeaux Bordeaux Bordeaux Bordeaux Bordeaux	P8  Blu Dark Blue Bleu Blau Blauw Azul	P2  Grigio Medio Medium Grey Gris Moyen Mittelgrau Gewoon Grijs Gris Harmigón	PG  Grigio Scuro Dark Grey Gris Foncé Dunkelgrau Donkergrijs Gris Oscuro	P1  Nero Black Noir Schwarz Zwart Negro
Lucia A + B  Sabbia - Aruba Sable - Aruba Sable - Aruba Sandfarbe - Aruba Zand - Aruba Arena - Aruba	A2  Matrone - Jamaica Brick-Coloured - Jamaica Brique - Jamaica Ziegelrot - Jamaica Baksteen - Jamaica Pardo Cobre - Jamaica	A3  Celeste - Arcibo Light Blue - Arcibo Bleu - Arcibo Hellblau - Arcibo Hemelsblauw - Arcibo Azul Celeste - Arcibo	A4  Blu - Martinique Blue - Martinique Bleu - Martinique Blau - Martinique Blauw - Martinique Azul - Martinique	A5  Pétrole - Windjammer Petroleum - Windjammer Pétrole - Windjammer Petroleum Blau - Windjammer Petroleum - Windjammer Petróleo - Windjammer	A6  Testa Di Moro - Sombrero Dark Brown - Sombrero Brun Gris - Sombrero Dunkelbraun - Sombrero Donkerbruin - Sombrero Pardo Grisáceo - Sombrero
Stay B  Giallo Yellow Jaune Gelb Geel Amarillo	Y2  Arancio Orange Orange Orange Oranje Naranja	Y3  Verde Green Vert Grün Groen Verde	Y4  Celeste Light Blue Bleu Hellblau Hemelsblauw Azul Celeste	Y5  Blu Avio Air Force Blue Bleu Aviation Avio Blau Avio-Blauw Azul Colombino	Y6  Grigio Londra London Grey Gris Londres London Grau Londen-Grijs Gris Londres
Xpress B  Giallo Primavera Spring Yellow Jaune Printemps Frühling Gelb lentegeel Amarillo Primavera	X2  Verde Sottobosco Underwood Green Vert Sous-Bois Unterholz Grün Bosgrond-Groen Verdes Sotobosque	X3  Blue Jeans Blue Jeans Denim Blue Blue Jeans Blau Jeansblauw Azul Denim			

A	B
Per sedute For armchair Pour les chaises Für Stühle Voor stoelen Para las sillas	Per schermi For screens Pour écrans Für Schirmwände Voor schermen Para las pantallas

Edizione Settembre 2018_Particolari tecnici ed estetici possono essere modificati senza preavviso. Le rese cromatiche non sono vincolanti così come la fedeltà della riproduzione. Dati, misure e dettagli devono essere verificati con il listino.

September 2018 edition_Technical and aesthetic details can be modified without notice. Colour rendering may differ. Check the data, measures and details on the price list.

Édition septembre 2018_Les détails techniques et esthétiques peuvent être modifiés sans préavis. Le rendu chromatique n'est pas contractuel, ainsi que la fidélité de la reproduction. Les données, les mesures et les détails doivent être vérifiés avec le tarif.

Ausgabe September 2018_Technische und ästhetische Details könnten ohne Vorankündigung geändert werden. Die Echtheit der Farbwiedergabe ist nicht verbindlich. Daten, Maße und Details sind in der Preisliste zu überprüfen.

Uitgave september 2018_Technische en esthetische details kunnen zonder voorafgaande kennisgeving gewijzigd worden. De kleuren zijn niet bindend, net als de nauwkeurigheid van de reproductie. Gegevens, afmetingen en details moeten gecontroleerd worden met de lijst.

Edición de septiembre de 2018_Los detalles técnicos y estéticos pueden ser modificados sin preaviso. Los rendimientos de color y la fidelidad de la reproducción no son vinculantes. Los datos, las medidas y los detalles deben ser verificados con la tarifa.

Bralco srl

Via Luigi Einaudi, 1
31058 Susegana · TV · Italy

T +39 0438 437 711
F +39 0438 437 730

info@bralco.it

milan

paris

london

bruxelles

valencia

athens

prague

www.bralco.it