

ALEA

titano

Titano nella mitologia è una figura caratterizzata da imponenza, coraggio e potenza dovuti ad una forza così grande da superare quella, talvolta antagonista, degli dei. Titano è la collezione direzionale di alta gamma che Alea propone e che si contraddistingue per un design dai segni forti e rigorosi che tracciano le linee proprie dell'eleganza colta e raffinata.

In mythology Titano (Titan) epitomizes majesty, courage and strength derived from a power, at times greater than that of the Gods, and which was periodically used against them. Titano is Alea's very latest high end Private office collection, defined by its bold, austere and inherently elegant design.

Titan dans la mythologie est la figure imposante caractérisée par le courage et la puissance fournis par une force tellement considérable qu'elle dépasse celle-même des dieux, parfois antagoniste. Titano est la collection de direction de prestige proposée par Alea et qui se distingue par son design aux traits forts et rigoureux qui déterminent les lignes propres à l'élégance cultivée et raffinée.

Titán en la mitología es la figura que se caracteriza por su tamaño impresionante, valor y potencia, fruto de una fuerza tan grande que sobrepasa hasta la de los dioses.

Titano es la línea ejecutiva de alto prestigio propuesta por Alea y que sobresale por su diseño de rasgos fuertes y rigurosos que determinan las líneas mismas de elegancia refinada.



L'eleganza del disegno si tramuta nell'attenta cura del dettaglio, nell'uso di materiali di grande qualità, nella sapiente maestria artigianale. La collezione Titano si veste di nuove finiture in essenza legnosa quali Ebanò Silver e Makassar e originali tonalità nei materiali melamminici come l'Ardesia e il Noisette. Il programma si articola in varie tipologie di tavoli: scrivanie freestanding con gambe a sezione rettangolare di mm 237X77 caratterizzate dall'innovativo assemblaggio a "schema libero" in quanto, al momento dell'aggregazione al piano, è possibile decidere la loro posizione secondo molteplici possibilità compositive che conferiscono originali e mutevoli personalità estetiche e funzionali.

The elegance of this design is expressed in our precise attention to detail, in the scrupulous use of quality materials and the unrivalled dexterity of our craftsmen. The Titano Collection boasts 2 new wood finishes; Ebanò Silver and Makassar and 2 new colors have been added to our melamine palette; Ardesia and Noisette. The collection comprises various types of tables including freestanding desks with legs that have rectangular sections of 237 mm x 77 mm. Prior to the installation of the desktop, it is possible to dramatically change both the look and functionality of the desk by modifying the direction of these rectangular legs.

L'élégance du dessin transparaît dans l'attention du détail, l'utilisation des matériaux de grande qualité, l'experte maîtrise artisanale. La collection Titano se revêt de nouvelles finitions en essence ligneuse telles que l'ébène Silver et le makassar ainsi que de tonalités originales des matériaux mélaminés comme l'Ardoise et la Noisette. Le programme s'articule autour de diverses typologies de tables: bureaux auto-porteurs aux piètements rectangulaires de 237mm x 77mm caractérisés par l'assemblage à schéma libre en tant que, au moment de l'assemblage, il est possible de choisir leur positionnement selon de multiples possibilités qui confèrent autant de personnalités esthétiques originales et fonctionnelles.

El cuidado de los detalles, la elección de materiales de alta calidad y la experta artesanía resaltan la elegancia del diseño. La colección Titano se viste con nuevos acabados en maderas tales como Ebanò Silver y Makassar, así como nuevas tonalidades de melaminas como Ardesia y Noisette. El programa se declina en varias tipologías de mesas: escritorios auto-portantes con patas de sección rectangular de 237mm x 77mm que se caracterizan por su gran modularidad de ensamblaje: al armar la superficie es posible ubicarlas de varias maneras creando múltiples composiciones de varias y originales personalidades estéticas y funcionales.







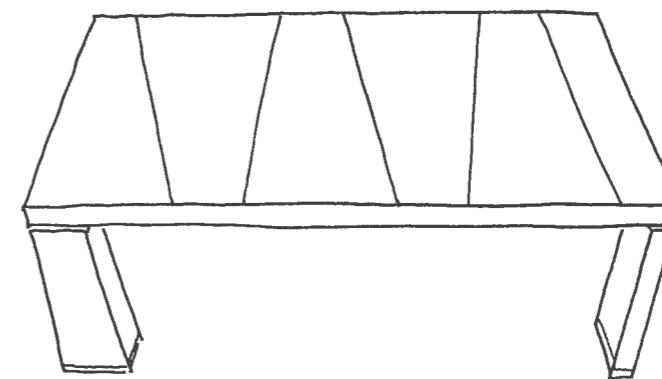

É possibile arricchire funzionalmente la postazione di lavoro, aggregando alla scrivania un mobile contenitore laterale oppure dotandola di un piano dattilo capace di aumentare notevolmente la superficie operativa. Oltre ai piani in essenza legnosa Ebano Silver e Makassar, Titano prevede piani rivestiti in cuoio con cuciture a vista di elementi dalla forma di trapezi o di poligoni irregolari e tali originali composizioni sono dettate dalla volontà progettuale, di utilizzare al massimo grado consentito, gli sfridi di lavorazione del cuoio: ecco un concreto esempio di "eco-disegno". In abbinamento ai tavoli vengono proposte consolle in legno con struttura a ponte: libere, o dotate di contenitore con antine quadrate.

The functionality of the workspace can be greatly enhanced by adding a mobile lateral storage unit to the desk or adding a return which greatly increases the size of the worksurface. In addition to worksurfaces in Silver Ebano and Makassar, Titan desktops are also available in leather with stitching in trapezoid or polygon patterns. In this way, leather remnants can be stitched together in a very original pattern, creating a genuine example of "eco-design". Free-standing consoles fitted with square doors and "bridge" consoles that attach to bookcases complete the collection of tables and desks.

Il est possible d'enrichir fonctionnellement la position de travail, en ajoutant au bureau un meuble latéral ou bien un retour qui augmente sensiblement la surface de travail. Outre les plans en essence Ebène Silver ou Makassar, Titano propose aussi des revêtements en cuir sur-piqué aux formes trapézoïdales ou en polygones irréguliers; de telles compositions originales sont dictées par la volonté conceptuelle de réemployer au maximum les chutes du travail du cuir: voici un un exemple concret de "eco-design". En complément des tables il est proposé aussi des consoles en bois avec structure en pont: libres ou bien dotées d'étagères à portes carrées.

Es posible enriquecer las funciones de los puestos de trabajo, añadiendo un mueble/archivo lateral al escritorio o conectando un ala que aumenta considerablemente la superficie de trabajo. Además de los topes en maderas Ebano Silver y Makassar, Titano ofrece también superficies cubiertas en cuero con costuras a vista de elementos con formas de trapezoides o de polígonos irregulares y tales composiciones originales derivan de la voluntad de usar al máximo los desperdicios de los trabajos del cuero: así se nota un ejemplo concreto de "eco-diseño". En complemento a las mesas se proponen credenzas en madera con estructura puente: liberas o conjuntas a estanterías con puertas cuadradas.





Il mobile laterale integrato alla scrivania, si compone di una scocca in materiale melamminico e di un'anta scorrevole con rivestimento ligneo. Il contenitore è provvisto di cassetti, classificatori, vani a giorno, di uno spazio porta cpu e dei necessari elementi tecnici dedicati al passaggio dell'elettrificazione.

The desk's integrated lateral storage unit has a melamine shell with a sliding door in contrasting wood. The storage unit offers drawers, open compartments, sections for files and a cpu holder which enables wire access from the desktop.

Le meuble latéral intégré au bureau se compose d'une structure en mélaminé et d'une porte coulissante en bois. Il est fourni de tiroirs, classeurs, élément ouvert et d'une espace pour l'unité centrale ainsi que des éléments nécessaires au câblage.

El mueble lateral combinado con el escritorio se compone de un casco en melamina y una puerta corrediza en madera. Incluye gavetas, clasificadores, estantes abiertos y porta-CPU así como los elementos técnicos para el cableado.







Le piccole riunioni trovano luogo utilizzando tavoli con basamenti in acciaio cromato e piani tondi o quadrati. Questi ultimi possono essere rivestiti in pelle con cuciture a vista, impreziositi da un originale design che nasce dall'utilizzo di forme geometriche irregolari e sempre diverse.

Small meeting tables are available with either round or square tops and a chrome steel base. The tables can be upholstered in leather with exposed stitching and further embellished with original designs using irregular geometric shapes.

Les petites réunions sont accueillies autour des tables à piètement en acier chromé et aux surfaces rondes ou carrées. Ces dernières peuvent aussi être recouvertes de cuir sur-piqué, soulignées par un dessin original fruit des formes irrégulières et toujours uniques.

Las pequeñas juntas aprovechan de las mesas con bases en acero cromado y superficies redondas o cuadradas. Estas pueden cubrirse de piel con costuras visibles, enriquecidas por un diseño original de formas geométricas irregulares y siempre únicas.











titano



I piani di forte spessore sono realizzati con un innovativo materiale stratificato, capace di conferire al manufatto alta resistenza meccanica e un peso dal valore contenuto. Allo scopo di utilizzare la minor quantità di materiale possibile, le gambe dei tavoli al loro interno sono cave e ciò si è reso possibile grazie all'utilizzo di tecnologie produttive all'avanguardia.

Thick panels are made of an innovative, stratified material, which increases their mechanical resistance. Thanks to our technological advances, the use of materials is kept to a minimum allowing our table legs to be hollow.

Les plans de forte épaisseur utilisent un matériau stratifié innovant, qui leur confère haute résistance mécanique tout en maintenant un poids raisonnable. Afin d'employer le moins de matière possible, les pieds sont creux, ce qui est rendu possible grâce à de nouvelles technologies productives d'avant-garde.

Los topes muy gruesos son de un material estratificado innovador que les confiere alta resistencia en un peso aceptable. Gracias a tecnologías productivas de vanguardia y para disminuir la cantidad de material necesario, las patas de las mesas son huecas.

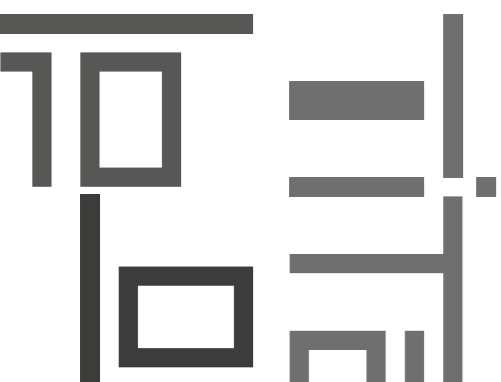







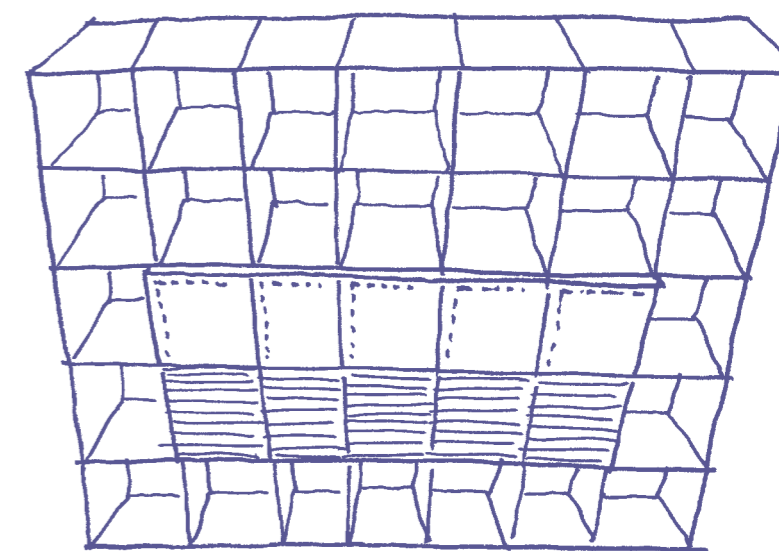

I tavoli riunione dalle forme rettangolari o dai lati lunghi a "curva tesa" prevedono gambe rettangolari, fianchi o supporti centrali a sezione rettangolare di mm 237 x 600 atti a contenere l'elettrificazione. Le librerie a giorno con scocca in melaminico Noisette e Ardesia prevedono una articolata componibilità sia verticale che orizzontale. Alle librerie è possibile applicare antine quadrate in legno, alluminio e vetro o melaminico oppure con rivestimento in pelle. E' possibile realizzare composizioni asimmetriche originali e di forte impatto estetico integrando opportunamente la consolle.

Rectangular conference tables may have either rectangular legs, panel-shaped legs or central supports with 237 mm x 600 mm rectangular sections that provide wire management. Bookcases with open compartments in Noisette or Ardesia melamine promote pronounced vertical and horizontal modularity. Square doors in either wood, aluminium, glass, leather or melamine can be fitted to the bookcase, creating original asymmetric patterns.

Les tables de réunion rectangulaires ou aux côtés longs courbes reposent sur des pieds rectangulaires, des flancs ou des supports centraux à section rectangulaire de 237mm x 600mm à même de recevoir le câblage électrique. Les librairies ouvertes à structure en mélamine Noisette et Ardoise autorisent une grande liberté de compositions soit verticales qu'horizontales. Les étagères acceptent des portes carrées en bois, aluminium et verre ou mélamine ou encore revêtues en cuir. Il est possible de réaliser des compositions asymétriques originales et de fort impact esthétique en intégrant de façon opportune les consoles.

Las mesas de junta rectangulares o de largos curvos prevén patas rectangulares, costados o soportes centrales de sección rectangular de 237mm x 600mm que permiten la subida de cables. Las librerías abiertas en melamina Noisette o Ardoise se declinan en una gran variedad de composiciones verticales o horizontales. También se pueden incluir puertas cuadradas en madera, aluminio y vidrio o melamina o también en piel. También se pueden crear composiciones asimétricas originales y muy estéticas integrando las credenzas.





Ogni tipologia strutturale nella quale Titano si configura prevede la soluzione del contenimento e del passaggio dell'elettrificazione.

All Titano structural storage units provide wire management and access solutions.

Chaque typologie structurelle dans laquelle se décline Titano prévoit la solution de rangement ou du passage de câbles.

Cada tipología estructural en la cual se configura Titano prevé la solución de almacenaje y del cableado.

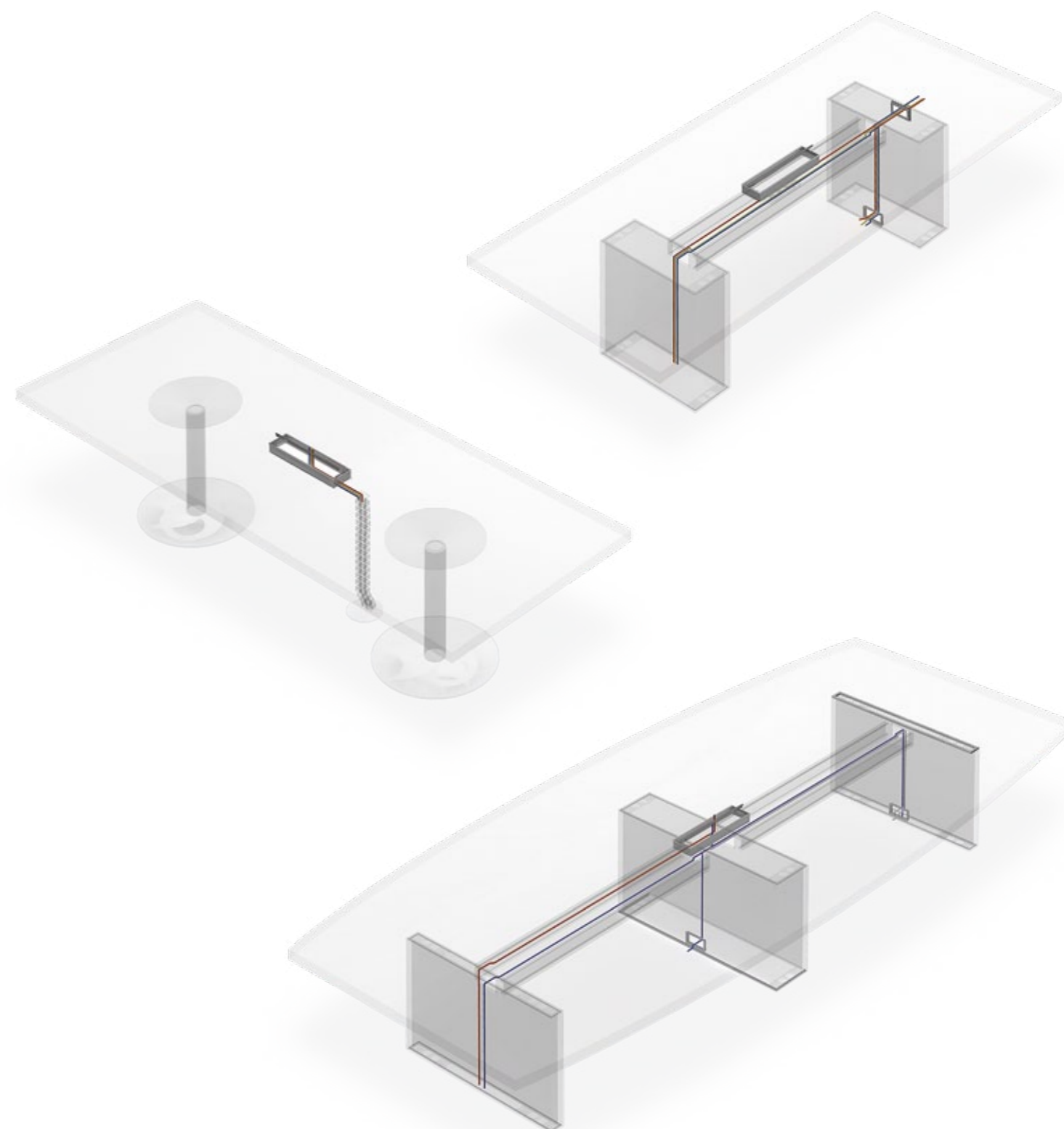
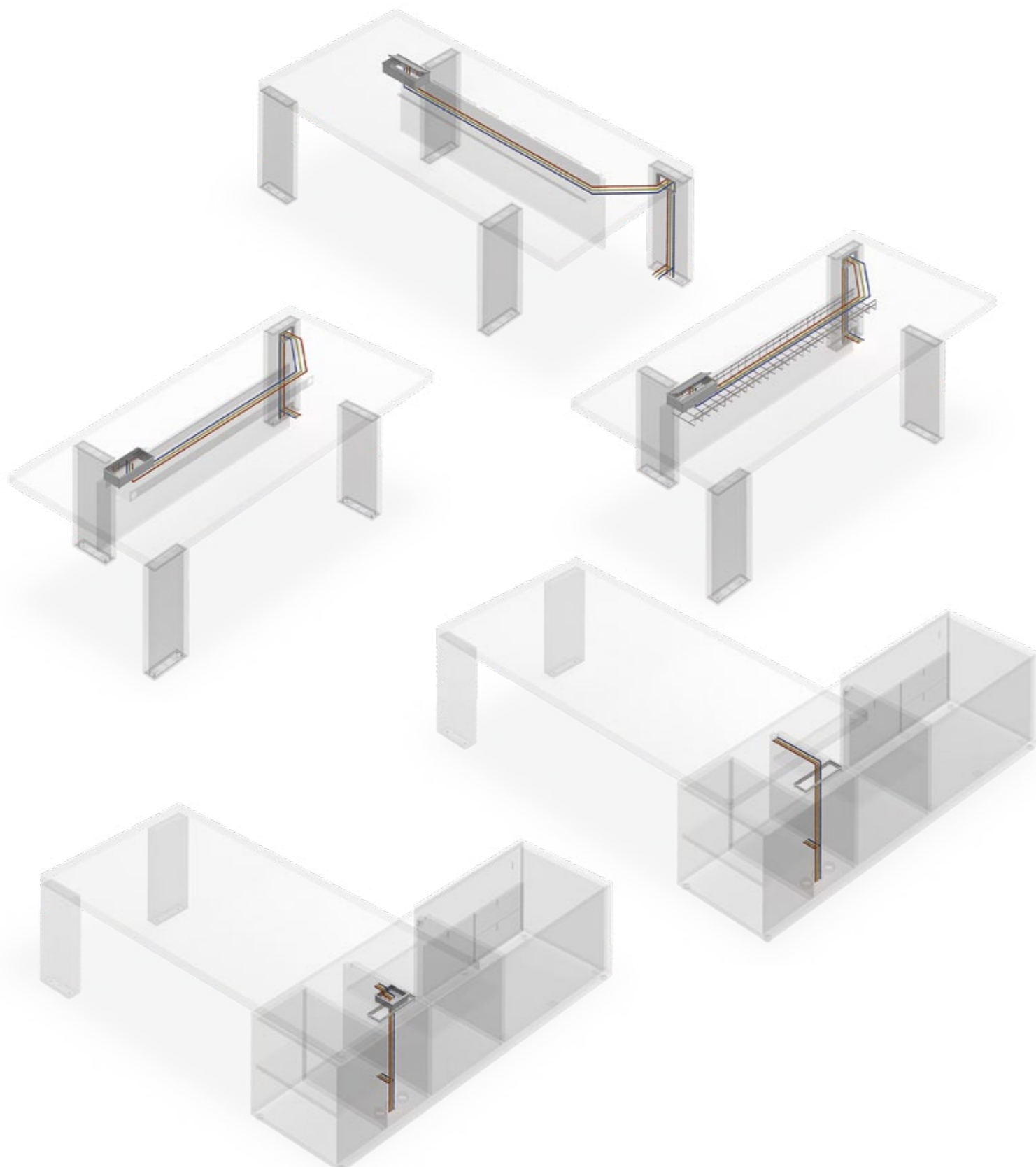
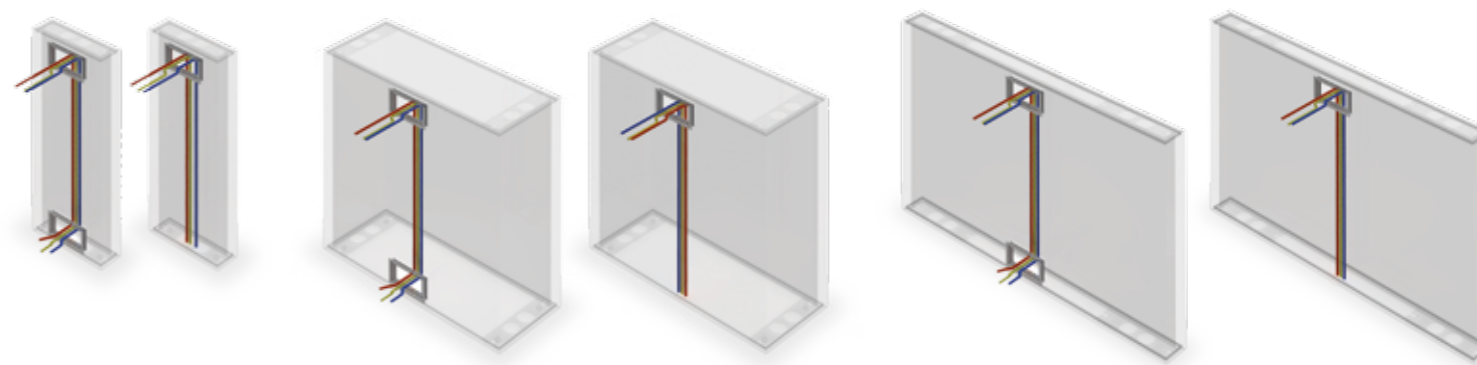

SCRIVANIA RETTANGOLARE P.100 (H.73,4)

Rectangular desk D.36 6/16" (H.28 14/16") - Bureau rectangulaire P.100 (H.73,4)
Mesa rectangular P.100 (H.73,4)

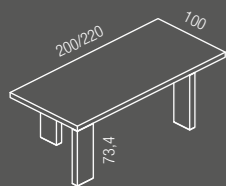

L. 200 Cod. **TI1120010**
L. 78 12/16" Cod. **TI1120010A**

L. 220 Cod. **TI1122010**
L. 86 10/16" Cod. **TI1122010A**

SCRIVANIA RETTANGOLARE P.100 (H.73,4)

Rectangular desk D.36 6/16" (H.28 14/16") - Bureau rectangulaire P.100 (H.73,4)
Mesa rectangular P.100 (H.73,4)

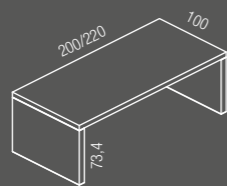

L. 200 Cod. **TI1120010A**
L. 78 12/16" Cod. **TI1120010A**

L. 220 Cod. **TI1122010A**
L. 86 10/16" Cod. **TI1122010A**

DATTILO AGGANCIATO P.60 (H.73,4)

Hanged return D.23 10/16" (H.28 14/16") - Retour accroché P.60 (H.73,4)
Ala suspendida P.60 (H.73,4)

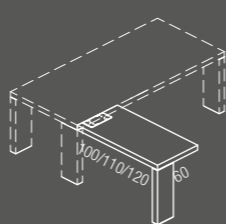

L. 100 Cod. **TI1010060**
L. 39 6/16" Cod. **TI1010060A**

L. 110 Cod. **TI1011060**
L. 43 5/16" Cod. **TI1011060A**

L. 120 Cod. **TI1012060**
L. 47 4/16" Cod. **TI1012060A**

TAVOLI RIUNIONE P.180 (H.73,4)

Conference table D.70 14/16" (H.28 14/16") - Tables de réunion P.180 (H.73,4)
Mesas de juntas P.180 (H.73,4)

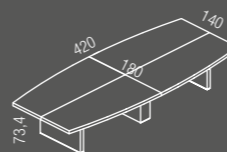

L. 420 Cod. **TI1242018**
L. 165 6/16" Cod. **TI1242018A**

TAVOLI RIUNIONE P.180 (H.73,4)

Conference table D.70 14/16" (H.28 14/16") - Tables de réunion P.180 (H.73,4)
Mesas de juntas P.180 (H.73,4)

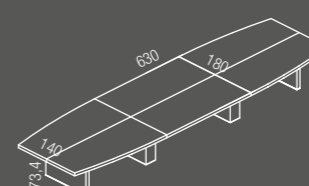

L. 630 Cod. **TI1263018**
L. 248 1/16" Cod. **TI1263018A**

TAVOLI RIUNIONE P.180 (H.73,4)

Conference table D.70 14/16" (H.28 14/16") - Tables de réunion P.180 (H.73,4)
Mesas de juntas P.180 (H.73,4)

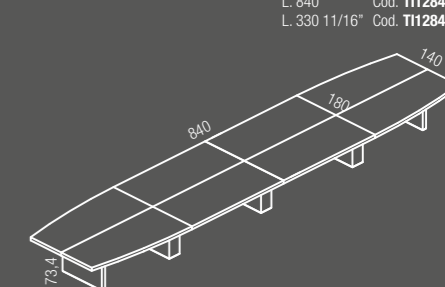

L. 840 Cod. **TI1284018**
L. 330 11/16" Cod. **TI1284018A**

DATTILO AGGANCIATO P.60 (H.73,4)

Hanged return D.23 10/16" (H.28 14/16") - Retour accroché P.60 (H.73,4)
Ala suspendida P.60 (H.73,4)

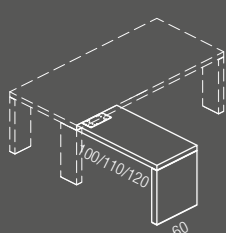

L. 100 Cod. **TI1010060A**
L. 39 6/16" Cod. **TI1010060A**

L. 110 Cod. **TI1011060A**
L. 43 5/16" Cod. **TI1011060A**

L. 120 Cod. **TI1012060A**
L. 47 4/16" Cod. **TI1012060A**

MODESTY

Modesty panel - Voile de fond - Faldón

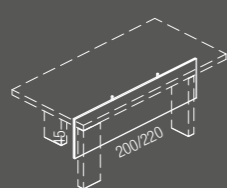

L. 200 Cod. **TI2620045**
L. 78 12/16" Cod. **TI2620045A**

L. 220 Cod. **TI2622045**
L. 86 10/16" Cod. **TI2622045A**

MODESTY

Modesty panel - Voile de fond - Faldón

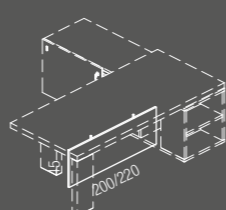

L. 200 Cod. **TI2620045A**
L. 78 12/16" Cod. **TI2620045A**

L. 220 Cod. **TI2622045A**
L. 86 10/16" Cod. **TI2622045A**

TAVOLINI P.60 (H.40)

Coffee table D. 23 10/16" (H.15 12/16") - Tables basse P.60 (H.40)

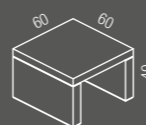

L. 60 Cod. **TI1306006**
L. 23 10/16" Cod. **TI1306006A**

TAVOLINI P.60 (H.40)

Coffee table D. 23 10/16" (H.15 12/16") - Tables basse P.60 (H.40)

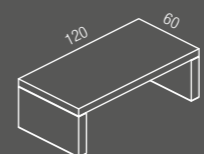

L. 120 Cod. **TI1312006**
L. 47 4/16" Cod. **TI1312006A**

CONSOLE P.60 (H.82)

Free-standing console D. 23 10/16" (H.32 5/16") - Console P.60 (H.82)
Console P.60 (H.82)

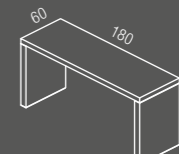

L. 180 Cod. **TI4318006**
L. 70 14/16" Cod. **TI4318006A**

TAVOLI RIUNIONE P.120 (H.73,4)

Conference table D.47 4/16" (H.28 14/16") - Tables de réunion P.120 (H.73,4)
Mesas de juntas P.120 (H.73,4)

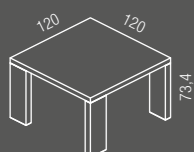

L. 120 Cod. **TI1212012**
L. 47 4/16" Cod. **TI1212012A**

TAVOLI RIUNIONE P.120 (H.73,4)

Conference table D.47 4/16" (H.28 14/16") - Tables de réunion P.120 (H.73,4)
Mesas de juntas P.120 (H.73,4)

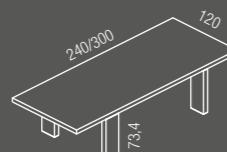

L. 240 Cod. **TI1224012**
L. 94 8/16" Cod. **TI1224012A**

L. 300 Cod. **TI1230012**
L. 118 2/16" Cod. **TI1230012A**

TAVOLI RIUNIONE P.120 (H.73,4)

Conference table D.47 4/16" (H.28 14/16") - Tables de réunion P.120 (H.73,4)
Mesas de juntas P.120 (H.73,4)

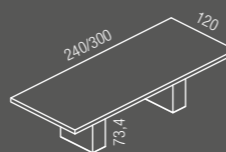

L. 240 Cod. **TI1224012A**
L. 94 8/16" Cod. **TI1224012A**

L. 300 Cod. **TI1230012A**
L. 118 2/16" Cod. **TI1230012A**

CONSOLE P.60 (H.82)

Free-standing console D. 23 10/16" (H.32 5/16") - Console P.60 (H.82)
Console P.60 (H.82)

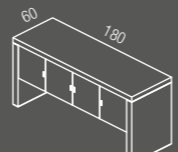

L. 180 Cod. **TI4318006A**
L. 70 14/16" Cod. **TI4318006A**

MOBILE DI SERVIZIO P.63 (H.66)

Lateral storage unit D. 24 13/16" (H.26) - Meuble retour P.63 (H.66)
Mueble de servicio P.63 (H.66)

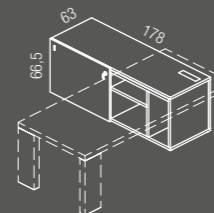

L. 178 Cod. **TI4417806**
L. 70 1/16" Cod. **TI4417806A**

MOBILE DI SERVIZIO P.63 (H.66)

Lateral storage unit D. 24 13/16" (H.26) - Meuble retour P.63 (H.66)
Mueble de servicio P.63 (H.66)

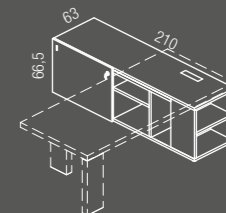

L. 210 Cod. **TI4421006**
L. 82 11/16" Cod. **TI4421006A**

TAVOLI RIUNIONE P.120 (H.73,4)

Conference table D.47 4/16" (H.28 14/16") - Tables de réunion P.120 (H.73,4)
Mesas de juntas P.120 (H.73,4)

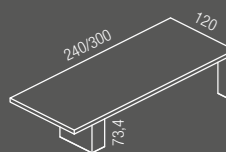

L. 240 Cod. **TI1224012B**
L. 94 8/16" Cod. **TI1224012B**

L. 300 Cod. **TI1230012B**
L. 118 2/16" Cod. **TI1230012B**

TAVOLI RIUNIONE P.120 (H.73,4)

Conference table D.47 4/16" (H.28 14/16") - Tables de réunion P.120 (H.73,4)
Mesas de juntas P.120 (H.73,4)

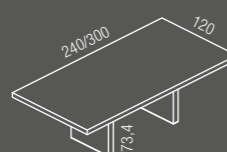

L. 240 Cod. **TI1224012C**
L. 94 8/16" Cod. **TI1224012C**

L. 300 Cod. **TI1230012C**
L. 118 2/16" Cod. **TI1230012C**

TAVOLI RIUNIONE D.120 (H.73,4)

Round table 47 4/16" (H.28 14/16") - Tables de réunion D.120 (H.73,4)
Mesas redondas D.120 (H.73,4)



D.120 Cod. **TI12D120**
47 4/16" Cod. **TI12D120A**

CASSETTIERA P.56 (H.35)

Drawers unit D. 22 1/16" (H.13 12/16") - Bloc tiroirs P.56 (H.35)
Buc de cajones P.56 (H.35)

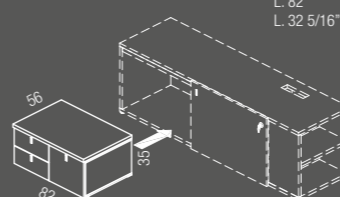

L. 82 Cod. **TICA08205**
L. 32 5/16" Cod. **TICA08205A**

RIPIANO CONTENITORE

Lateral storage shelf - Tablette pour meuble retour
Estante para mueble de servicio

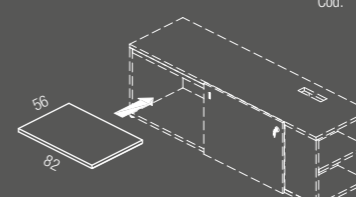

Cod. **TICARI01**

TOP CONTENITORE P.60

Lateral storage top D. 23 10/16" - Top de finition pour meuble retour P.60
Top para mueble de servicio P.60

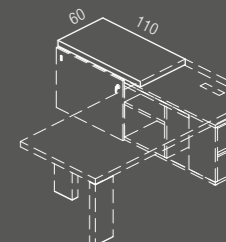

L. 110 Cod. **TI1P11006**
L. 43 5/16" Cod. **TI1P11006A**

TAVOLI RIUNIONE P.120 (H.73,4)

Conference table D.47 4/16" (H.28 14/16") - Tables de réunion P.120 (H.73,4)
Mesas de juntas P.120 (H.73,4)

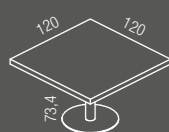

L.120 Cod. **TI1212012A**
47 4/16" Cod. **TI1212012A**

TAVOLI RIUNIONE P.120 (H.73,4)

Conference table D.47 4/16" (H.28 14/16") - Tables de réunion P.120 (H.73,4)
Mesas de juntas P.120 (H.73,4)

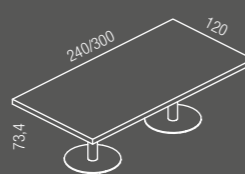

L. 240 Cod. **TI1224012D**
L. 94 8/16" Cod. **TI1224012D**

L. 300 Cod. **TI1230012D**
L. 118 2/16" Cod. **TI1230012D**

TAVOLI RIUNIONE P.120 (H.73,4)

Conference table D.47 4/16" (H.28 14/16") - Tables de réunion P.120 (H.73,4)
Mesas de juntas P.120 (H.73,4)

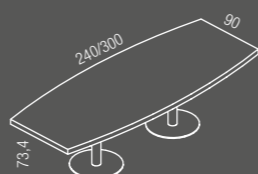

L. 240 Cod. **TI1224012E**
L. 94 8/16" Cod. **TI1224012E**

L. 300 Cod. **TI1230012E**
L. 118 2/16" Cod. **TI1230012E**

LIBRERIA

Bookcase - Bibliothèque - Librería

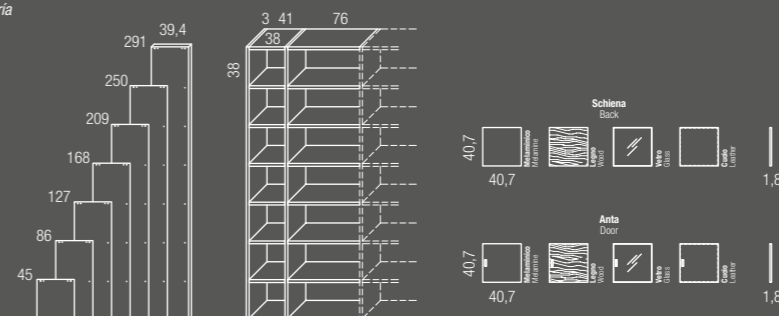

scrivania, dattilo, tavoli, tavolini

desk, return, meeting tables, coffee tables - bureaux, retours, tables, tables basses
mesas, alas, mesas de juntas, mesitas



| | | | | | | | |
|--|---|--|--|--|--|---|---|
| Ebano Silver Silver ebony Ebony silver Ebano plata | Ebano Makassar Makassar ebony Ebony makassar Ebano makassar | Cuoio bianco White leather Cuir blanc Cuero blanco | Cuoio nero Black leather Cuir noir Cuero negro | Cuoio testa di moro Brown leather Cuir tete de maure Cuero marrón oscuro | Cuoio alluminio Aluminium leather Cuir aluminium Cuero aluminio. | Cuoio arancione Orange leather Cuir orange Cuero naranja. | Cuoio indaco Indigo leather Cuir indigo Cuero azul fuerte |
|--|---|--|--|--|--|---|---|

solo piano desktop only seulement pour le plateau solo sobre mesa

scozza libreria, contenitore di servizio

bookshelf structure, side storage unit - structure des bibliotheques, et meubles de service
estructura libreria, mueble de servicio



| | |
|---|---|
| Ardesia Ardesia Ardoise Pizarra | Noisette Noisette Noisette Noisette |
|---|---|

fianchi & top di finitura libreria

bookshelf finishing sides and top - flancs et tops de finition des bibliotheques
costados y top de acabado libreria fur regal



| | |
|--|---|
| Ebano Silver Silver ebony Ebony silver Ebano plata | Ebano Makassar Makassar ebony Ebony makassar Ebano makassar |
|--|---|

ante libreria, schiene libreria, ante consolle

bookshelf doors, bookshelf backs, console doors - portes et fonds des bibliotheques, portes des consoles
puertas libreria, traseras librerias, puertas consolle

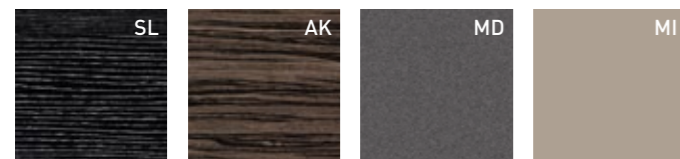

| | | | |
|--|---|---|---|
| Ebano Silver Silver ebony Ebony silver Ebano plata | Ebano Makassar Makassar ebony Ebony makassar Ebano makassar | Ardesia Ardesia Ardoise Pizarra | Noisette Noisette Noisette Noisette |
|--|---|---|---|



| | | | | | |
|---|--|---|---|--|--|
| Rosso trasparente Red transparent Rouge transparent Rojo transparente | Bleu trasparente Blue transparent Bleu transparent Azul transparente | Arancione satinato Satin-finish orange Orange satiné Naranja satinado | Bianco satinato Satin-finish white Blanc satiné Blanco satinado | Blu satinato Satin-finish blue Bleu satiné Azul satinado | Verde satinato Satin-finish green Vert satiné Verde satinado |
|---|--|---|---|--|--|

anta contenitore di servizio, modesty panel

side storage sliding door, modesty panel - portes des meubles de service, voiles de fond
puerta muebles de servicio, faldon



| | | | | |
|--|---|---|---|---|
| Ebano Silver Silver ebony Ebony silver Ebano plata | Ebano Makassar Makassar ebony Ebony makassar Ebano makassar | Ardesia Ardesia Ardoise Pizarra | Noisette Noisette Noisette Noisette | Cromo Chrome Chrome Cromo |
|--|---|---|---|---|

basamenti tavoli riunione

base for meeting tables - pietement pour tables de réunion
base para mesas de juntas

- Le finiture contenute nel presente catalogo sono puramente indicative e non sono di riferimento per le forniture del prodotto.
- Due to the printing process, finishes shown in this catalogue are for illustration only. The finish on the final item may differ slightly from the printed illustration.
- Les finitions contenues dans ce catalogue ne sont pas contractuelles - les photos ne pouvant rendre la parfaite réalité.
- Los acabados contenidos en este catálogo son puramente indicativos y no son de referencia para los suministros del producto.

ALEA

design

Mirto Antonel
& Filippon

art direction

Mirto Antonel

fotografia

GFP

fotolito

GFP

AI/CABB/AA

titano



ALEA

ALEA srl - Via Col de Rust, 19 - 33070 Sarone (PN) - ITALIA
Tel. ++39.0434.777333 - Fax ++39.0434.779903
www.aleaoffice.com - e-mail: info@aleaoffice.com

ALEA USA INC. - 3449 NE 1st Avenue, Mews L-32 - Miami FL 33137
Tel. 305 470-1200 - Fax 305 470-9070
www.alea-usa.com - e-mail: info@alea-usa.com

SHOWROOM: **MILANO 20123**
Via Giacomo Leopardi, 12
Tel. 800.081.001

